

# Product Catalog

---



# Product Catalog

---





Every business starts with a vision. Ours is simple: We want to create the best possible dental implant solutions that offer uncompromising quality at an affordable price. It's our people that help our business thrive and grow. That's why we place so much importance on building strong personal relationships that enable us to meet our doctors' and distributors' needs. Understanding that their success is our success, we're focused on providing professional, high quality and affordable solutions and exceptional service that help them grow.

## Expertise

Our high-quality products, combine innovation with reliability and ease of use, are designed to meet your professional requirements and your patients' needs.

With Adin, you have peace of mind.

## Rewarding

Adin is focused on offering affordable solutions for patients and profitable solutions for dental professionals, without compromising on quality.

## Recognition

We take your success personally and are dedicated to serving your needs. We take pride in solving your challenges and devising innovative solutions. We're here for you, providing unmatched personal attention and exceptional service.



<b>Internal Hex</b> .....	7
Internal Hex Implants .....	8
<b>Touareg™ S/OS</b> .....	9-13
Touareg™ S/OS Drill Sequence.....	14
<b>Swell™</b> .....	15-16
Swell™ Drill Sequence.....	17
Cover Screw & Healing Abutments.....	18
Impression .....	19-29
Drills & Tools .....	30-37
Surgical Kits .....	38-43
Guided Surgery .....	44-51
CAD CAM .....	52-60

<b>CloseFit™ RP Implant</b> .....	88
Drill Sequence .....	89
Cover Screw & Healing Abutments .....	89
CloseFit™ RP Impression .....	90-99
<b>CloseFit™ WP Implant</b> .....	100
Drill Sequence .....	101
Cover Screw & Healing Abutments ...	101
CloseFit™ WP Impression .....	102-111
Drills & Tools .....	112-116
Surgical Kits .....	117-123
Guided Surgery .....	124-133
CAD CAM .....	134-150



<b>Conical Connection</b> .....	61-62
Narrow Implants .....	63-65
<b>CloseFit™ NP Implant</b> .....	66
Drill Sequence .....	67
Cover Screw & Healing Abutments .....	67
CloseFit™ NP Impression .....	68-77
<b>CloseFit™ UNP implant</b> .....	78
Drill Sequence .....	79
Cover Screw & Healing Abutments .....	79
CloseFit™ UNP Impression .....	80-84
<b>Regular &amp; Wide Implants</b> .....	85-87



<b>One™ piece implant</b> .....	151-154
Drill Sequence .....	155
Prosthetic Kit .....	156-159
Stopper kits .....	160-167
Index .....	167-180



Illustrations are not to scale  
 Availability of the products in some places is limited and depends on local regulations.  
 For more information, please contact your local representative.

# Internal Hex



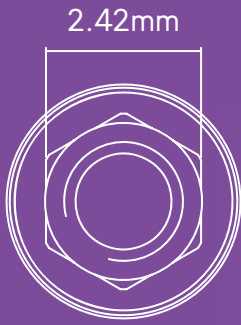

## Internal Hex

Our Internal Hex connection implant systems - Touareg S/OS are tapered implants with a spiral tap designed to condense bone during placement for enhanced immediate stability. The two large variable threads & a tapered core enable accurate implant placement, self-tapping, improved aesthetics and better load distribution.

The Touareg™-OS & Touareg™-S implants both feature a special round apex that pushes the bone graft with minimal harm to anatomical structures.

The Swell™ - An Internal Hex connection, hybrid implant with parallel body and tapered apex, with a V-shaped thread design.

The Touareg™-OS, Touareg™-S & Swell™- implants are user friendly and their unique design often allows for immediate function.





# Touareg™ S/OS

Our most popular implant. Made for simple & streamlined use featuring a high stability mechanism & unique surface treatment with an Internal Hex connection.

**Stability** – Our Touareg™ implant features an active & dynamic self-drilling threads, engineered to provide Ideal primary stability and immediate loading capabilities in all bone types. Designed for confidence & predictable procedures.

**One Connection** – All Touareg™ diameters and restorative parts connect with one unified Internal Hex Connection to simplify management of surgical & prosthetic procedures.

**OsseoFix™** – A biocompatible surface treatment that uses gritting with Calcium Phosphate media that is debris free and has been designed to achieve the desired roughness levels needed for optimal osseointegration.

**AB/AE** – Provides roughened micro and nano-structure surface topography. This structure leads to optimal cell adherence and proliferation in the cavities of the roughened implant surface, significantly increasing the number of cells attached to the surface and is associated with a shorter healing time.



Single restoration system to simplify management of surgical & prosthetic components

Implant diameter  
Ø 3.5-6mmD

Built-in platform switching

Immediate function capability

**Micro Threads:**  
Engineered to enhance bone regeneration, prevent bone loss & increase bone implant contact

Designed to provide high primary stability in all bone types

Minimally invasive surgery

Self drilling

Double lead threads 2.4mm(2×1.2)  
For fast & efficient insertion

Redirecting capability for optimal placement

Round apex



	Ø mm	L mm	D3 mm	Catalog No.
	3.5	8.00	3.05	ISPS0835
		10.00	3.00	ISPS1035
		11.50	2.90	ISPS1135
		13.00	2.90	ISPS1335
		16.00	2.90	ISPS1635
		18.00	2.90	ISPS1835
	3.75	8.00	3.15	ISPS0838
		10.00	3.10	ISPS1038
		11.50	3.10	ISPS1138
		13.00	3.05	ISPS1338
		16.00	3.00	ISPS1638
		18.00	3.00	ISPS1838
	4.2	6.25	3.70	ISPS0642
		8.00	3.40	ISPS0842
		10.00	3.40	ISPS1042
		11.50	3.35	ISPS1142
		13.00	3.30	ISPS1342
		16.00	3.25	ISPS1642
	5.0	6.25	4.50	ISPS0650
		8.00	4.20	ISPS0850
		10.00	4.15	ISPS1050
		11.50	4.10	ISPS1150
		13.00	4.10	ISPS1350
		16.00	4.05	ISPS1650
	6.0	6.25	5.50	ISPS0660
		8.00	5.20	ISPS0860
		10.00	5.15	ISPS1060
		11.50	5.10	ISPS1160
		13.00	5.10	ISPS1360

	Ø mm	L mm	D3 mm	Catalog No.
	<b>3.5</b>	8.00	3.05	ISF0835
		10.00	3.00	ISF1035
		11.50	2.90	ISF1135
		13.00	2.90	ISF1335
		16.00	2.90	ISF1635
		18.00	2.90	ISF1835
	<b>3.75</b>	8.00	3.15	ISF0838
		10.00	3.10	ISF1038
		11.50	3.10	ISF1138
		13.00	3.05	ISF1338
		16.00	3.00	ISF1638
		18.00	3.00	ISF1838
	<b>4.2</b>	6.25	3.70	ISF0642
		8.00	3.40	ISF0842
		10.00	3.40	ISF1042
		11.50	3.35	ISF1142
		13.00	3.30	ISF1342
		16.00	3.25	ISF1642
		18.00	3.20	ISF1842
	<b>5.0</b>	6.25	4.50	ISF0650
		8.00	4.20	ISF0850
		10.00	4.15	ISF1050
		11.50	4.10	ISF1150
		13.00	4.10	ISF1350
		16.00	4.05	ISF1650
	<b>6.0</b>	6.25	5.50	ISF0660
		8.00	5.20	ISF0860
		10.00	5.15	ISF1060
		11.50	5.10	ISF1160
		13.00	5.10	ISF1360

## Drill Sequence

Recommended drilling speed up to 1200 rpm

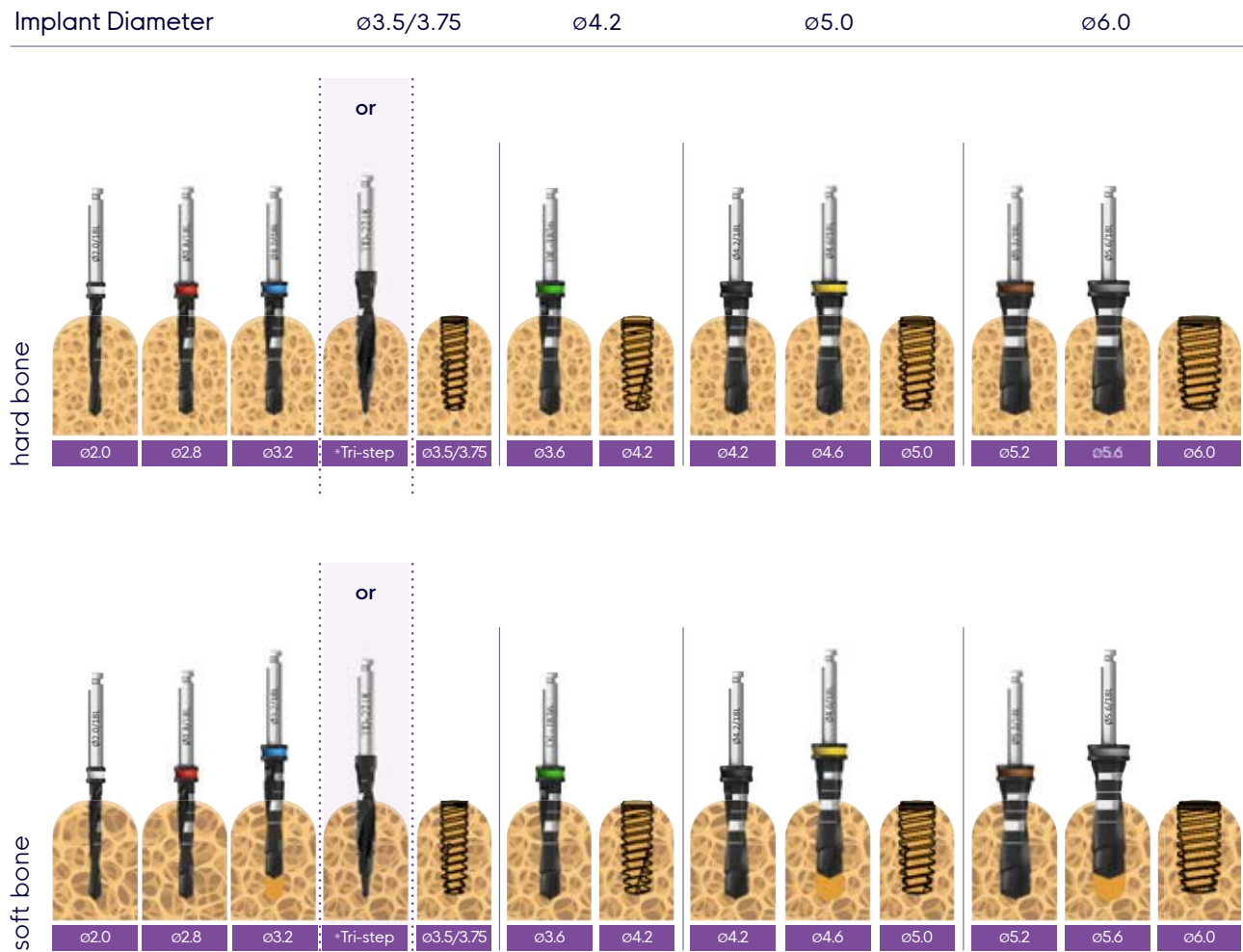

All measurements are in mm.

\*For initial drilling, you may use Tri-step drill instead of ø2, ø2.8 and ø3.2 drills in sequence.



The Swell™ - A hybrid implant with a parallel body, tapered apex and a V-shaped thread design. Its unique design allows for accurate positioning, improved aesthetics and better load distribution. Recommended for use in the mandibular arch.

The Swell™ implant features Alumina Oxide Blasted/Acid Etched (AB/AE) surface treatment.

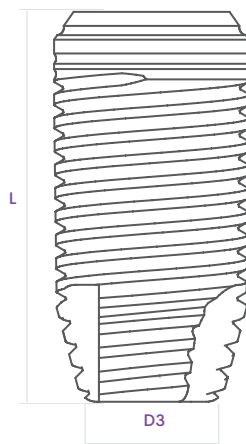

	Ø mm	L mm	D3 mm	Catalog No.
	<b>3.3</b>	10.00	2.70	ID1033
		11.50	2.70	ID1133
		13.00	2.70	ID1333
		16.00	2.70	ID1633
		18.00	2.70	ID1833
	<b>3.75</b>	8.00	2.40	ID0838
		10.00	2.30	ID1038
		11.50	2.30	ID1138
		13.00	2.25	ID1338
		16.00	2.20	ID1638
		18.00	2.10	ID1838
	<b>4.2</b>	6.25	2.90	ID0642
		8.00	2.90	ID0842
		10.00	2.80	ID1042
		11.50	2.80	ID1142
		13.00	2.75	ID1342
		16.00	2.70	ID1642
		18.00	2.60	ID1842
	<b>5.0</b>	6.20	3.70	ID0650
		8.00	3.60	ID0850
		10.00	3.60	ID1050
		11.50	3.50	ID1150
		13.00	3.50	ID1350
		16.00	3.40	ID1650
	<b>6.0</b>	6.20	4.70	ID0660
		8.00	4.60	ID0860
		10.00	4.60	ID1060
		11.50	4.50	ID1160
		13.00	4.50	ID1360

## Drill Sequence

Recommended drilling speed up to 1200 rpm

Implant Diameter  $\varnothing 3.3$

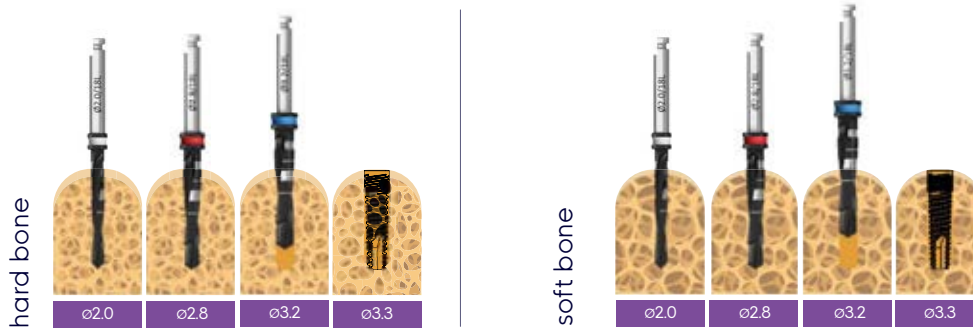

Implant Diameter  $\varnothing 3.75$        $\varnothing 4.2$        $\varnothing 5.0$        $\varnothing 6.0$

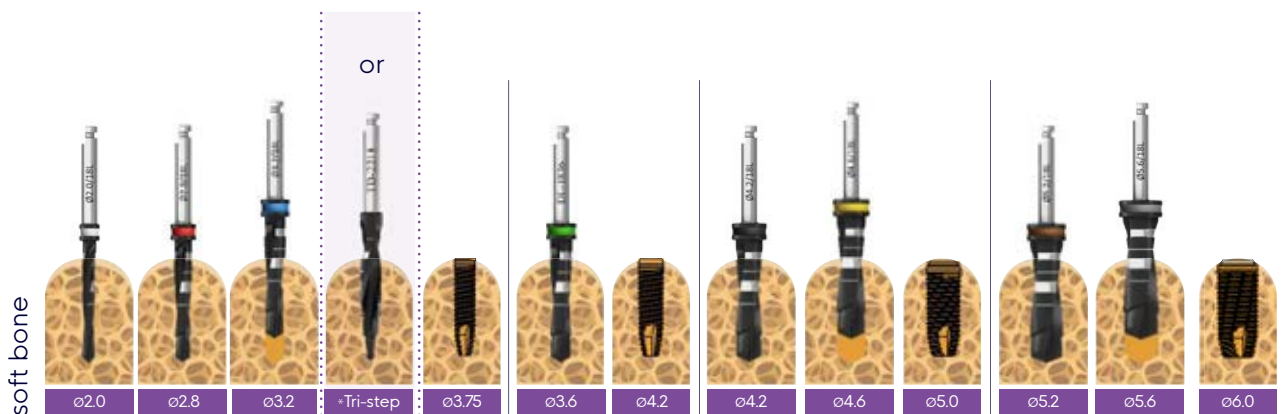
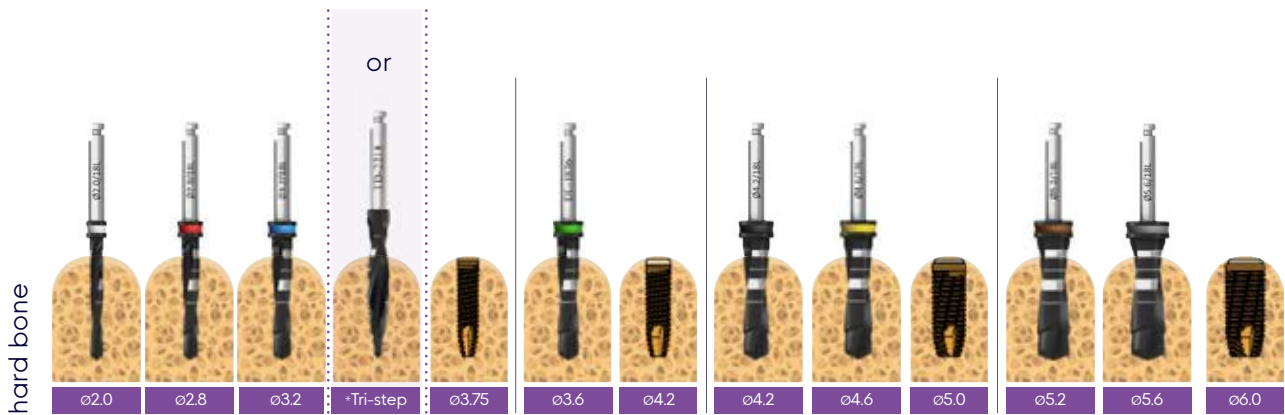

All measurements are in mm.

\*For initial drilling, you may use Tri-step drill instead of  $\varnothing 2$ ,  $\varnothing 2.8$  and  $\varnothing 3.2$  drills in sequence.



## Cover Screw & Healing Abutments

Recommended Torque 15(Ncm)

### RS Implant Cover Screw



Packed with implant  
RS3435

### RS Regular Healing Abutment



RS3022, GH2/L6.9  
RS3023, GH3/L7.9  
RS3024, GH4/L8.9  
RS3025, GH5/L9.9  
RS3026, GH6/L10.9  
RS3042, GH7/L11.9

### RS Slim Healing Abutment

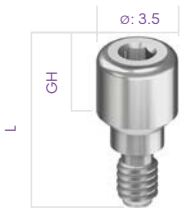

RS3027, GH2/L6.7  
RS3028, GH3/L7.7  
RS3029, GH4/L8.7  
RS3030, GH5/L9.7  
RS3031, GH6/L10.7  
RS3040, GH7/L11.7

### RS Wide Healing Abutment



RS3012, GH2/L6.8  
RS3013, GH3/L7.8  
RS3014, GH4/L8.8  
RS3015, GH5/L9.8  
RS3016, GH6/L10.8  
RS3017, GH7/L11.8





# Impression

Recommended Torque 15(Ncm)



Our components for taking impressions for all restoration types can be successfully utilized for digital or conventional protocols either implant-level or abutment level procedures.

Our broad range of solutions and flexible designs enable easy and accurate restorative planning, whether you're dealing with a single tooth, multiple teeth, bridge or full mouth rehabilitation.

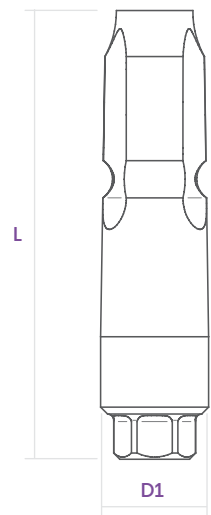





## Transfers & Analogs (Implant level)

Open Tray		L	D1	Catalog No.
	RS Open Tray Slim Transfer - Short	13.7	5.5	RS3510
	RS Open Tray Slim Transfer - Long	17.7	5.5	RS3514
	RS Open Tray Transfer	13.7	6.3	RS4510
	RS Open Tray Transfer	17.7	6.3	RS4514

Close Tray		L	D1	Catalog No.
	RS Slim Closed Tray Transfer - Short	10.7	3.5	RS5109
	RS Slim Closed Tray Transfer- Long	14.7	3.5	RS5113
	RS Closed Tray Transfer	10.7	4.5	RS5209
	RS Closed Tray Transfer	14.7	4.5	RS5213

Digital impression		H	D1	Catalog No.
	RS Scan body	7	-	RS0088
		10	-	RS0089





Analog		L	D1	Catalog No.
	RS Internal Hex Implant Analog	12.6	3.7	RS5737
	RS Digital Model Analog	10	3.75	RS1000

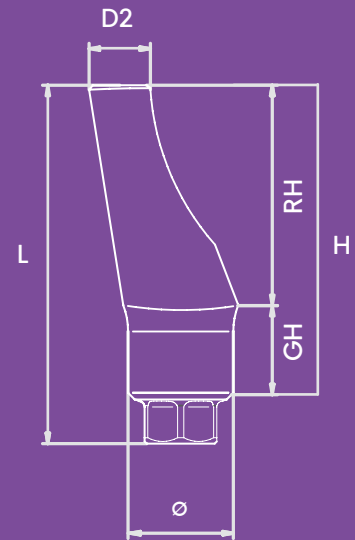

# Cement Retained Restoration

Recommended Torque 35(Ncm)



Abutments		L	Ø	D2	H	GH	RH	Catalog No.
	RS Esthetic Straight Abutment	9.2	4.5	3	7.5	1	6.5	RS0010
		10.2	4.5	3	8.5	2	6.5	RS0011
		11.2	4.5	3	9.5	3	6.5	RS0012
	RS Straight Titanium Abutment - No End Line	10.4	4.5	3.5	8.5	1	7.5	RS3800
	RS Straight Titanium Abutment	10.3	4.5	3	8.7	1	7.7	RS3801
	RS Straight Titanium Abutment	11.3	4.5	3	9.7	2	7.7	RS3802
	RS Straight Titanium Abutment	12.3	4.5	3	10.7	3	7.7	RS3803
	RS Straight Titanium Abutment	13.3	4.5	3	11.7	4	7.7	RS3804
	RS Straight Titanium Abutment	14.3	4.5	3	12.7	5	7.7	RS3805
	RS Straight Titanium Abutment Long	14.2	4.5	3.5	12.5	1.5	11	RS3811
	RS Wide Profile Titanium Abutment	10.5	4.5	4.5	8.9	1.9	7	RS3890

For prosthetic drivers please use hex driver 1.27, page 35-36

Abutments		L	∅	D2	H	GH	RH	Catalog No.
	RS Slim Titanium Abutment	5.3	3.9	3.3	3.6	0.6	3	RS3903
	RS Slim Titanium Abutment	7.9	3.9	3.3	6.2	0.6	5.6	RS3906
	RS Slim Titanium Abutment	10.4	3.9	3.3	8.6	0.6	8	RS3908
	RS Titanium Abutment 5.0 mmD Wide	11.2	5.0	3.2	9.6	2.2	7.4	RS3950
	RS Angled Titanium Abutment 15°	10.5	4.7	2.6	8.8	1.6	7.2	RS4015
	RS Angled Titanium Abutment 15° Long	13.1	4.68	1.8	11.5	1.5	10	RS4016
	RS Slim Angled Abutment 15° - No End Line	10.0	3.8	2.2	8.4	1	7.4	RS4017
	RS Slim Angled Abutment 15° - No End Line	11.0	3.8	2.2	9.4	2	7.4	RS4018
	RS Slim Angled Abutment 15° - No End Line	12.0	3.8	2.2	10.4	3	7.4	RS4019
	RS Angled Titanium Abutment 25°	10.6	4.7	2.5	9	2	7	RS4025
	RS Angled Titanium Abutment 35°	11.5	4.9	3.3	10	2	8	RS4035
	RS Esthetic Angled Titanium Abutment 15°	10.0	4.6	2.3	8.3	1	7.3	RS4115
	RS Esthetic Angled Titanium Abutment 15°	11.0	4.6	2.3	9.3	2	7.3	RS4117
	RS Esthetic Angled Titanium Abutment 15°	12.0	4.6	2.3	10.3	3	7.3	RS4119
	RS One Piece Screw-In Abutment	15.3	4.5	3.2	10.8	1.5	9.3	RS3812

Temporary Restoration		L	∅	D2	H	GH	RH	Catalog No.
	RS Engaging Straight Cylindrical Titanium Abutment	11.5	4.5	3.2	9.9	2	7.9	RS3411
	RS Non-Engaging Straight Cylindrical Titanium Abutment	11.5	4.5	3.2	9.9	2	7.9	RS3422

For prosthetic drivers please use hex driver 1.27, pages 35-36



# Screw - Retained Restoration Casting Abutments

Recommended Torque 35(Ncm)

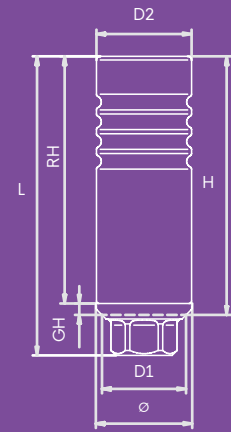

Casting Abutments		L	∅	D1	D2	H	GH	RH	Catalog No.
	RS Engaging Gold/Plastic Abutment	12.1	3.9	3.4	-	10.5	0.5	10	RS3090
	RS Engaging Plastic Casting Standard Abutment	10.5	4.5	3.4	3.5	8.9	0.8	7.9	RS5010
	RS Engaging Titanium/Plastic Abutment	13.0	4.9	3.4	-	11.4	1.4	10.0	RS3095
	RS Non-Engaging Titanium/Plastic Abutment	12.4	4.9	3.4	-	11.0	1.4	9.6	RS3097
	RS Engaging Cobalt Chrome/Plastic Abutment	12.1	3.9	3.4	3.9	10.5	0.5	10.0	RS3094
	RS Non-Engaging Cobalt Chrome/Plastic Abutment	12.1	3.9	3.4	3.9	10.5	0.5	10.0	RS3100
	RS Engaging Plastic Cylinder Casting Abutment	13.0	3.9	3.4	3.2	11.4	0.6	10.8	RS5000
	RS Non-Engaging Plastic Cylinder Casting Abutment	13.0	3.9	3.4	3.2	11.4	0.6	10.8	RS5020
	RS Engaging Plastic Standard Abutment	10.5	4.5	3.4	3.5	8.9	2.0	6.9	RS5030
	RS Non-Engaging Plastic Standard Abutment	10.5	4.5	3.4	3.5	8.9	1.0	7.9	RS5050
	RS Engaging Plastic Cylinder Abutment	10.5	3.9	3.4	3.9	9.1	0.2	8.9	RS5040
Screws		L	∅	D1	D2	H	GH	RH	Catalog No.
	RS Prosthetic Screw	9.5	2.1	-	2.1	-	-	-	RS3400
	RS Short Prosthetic Screw	8.2	2.1	-	2.1	-	-	-	RS3402
	RS Screw for Angled Titanium Abutment	8.2	2.4	-	2.4	-	-	-	RS3480
	Open Tray Screw Short	25	3.1	-	-	-	-	-	RS3428
	Open Tray Screw Long	29	3.1	-	-	-	-	-	RS3429
	Close Tray Transfer Screw Short	16.5	3.1	-	-	-	-	-	RS5126
	Close Tray Transfer Screw Long	20.5	3.1	-	-	-	-	-	RS5127





For prosthetic drivers please use hex driver 1.27, page 35-36

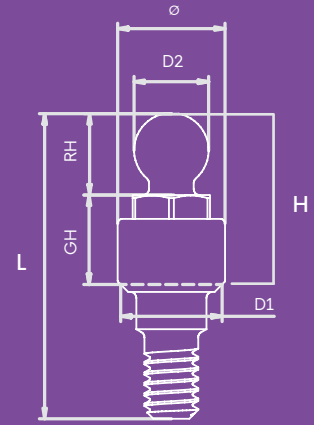

# Overdenture Restoration

Recommended Torque 35(Ncm)



		L	Ø	D1	D2	H	GH	RH	Catalog No.
	Plastic Ball Cap White (Nylon)	2.6	4.1	-	3.6	-	-	-	RS2660
	Plastic Ball Cap Pink Soft (Nylon)	2.6	4.1	-	3.6	-	-	-	RS2662
	Titanium Ball Cap	2.9	4.7	-	4.7	-	-	-	RS2670
	Stainless Steel Ball Cap	2.9	4.7	-	4.7	-	-	-	RS2675SS
	RS Ball Attachment	7.45	4	3.4	2.5	2.95	0.5	2.45	RS2650
		7.95	4	3.4	2.5	3.45	1	2.45	RS2651
		8.95	4	3.4	2.5	4.45	2	2.45	RS2652
		9.95	4	3.4	2.5	5.45	3	2.45	RS2653
		-	4	3.4	2.5	6.45	4	2.45	RS2654
		11.95	4	3.4	2.5	7.45	5	2.45	RS2655
	RS Ball Attachment	8.2	3.6	3.4	2.5	3.7	1	2.7	RS2861
		9.2	3.6	3.4	2.5	4.7	2	2.7	RS2862
		10.2	3.6	3.4	2.5	5.7	3	2.7	RS2863
		11.2	3.6	3.4	2.5	6.7	4	2.7	RS2864
		12.2	3.6	3.4	2.5	7.7	5	2.7	RS2865
		13.2	3.6	3.4	2.5	8.7	6	2.7	RS2866
	Ball Attachment Replica	16.6	4.0	-	-	-	0.8	2.7	RS5740

## Ball Attachment Driver



Torque Driver for Ball Attachment

RS6090





# TMA™ - Multi Unit

Recommended Torque 35(Ncm)

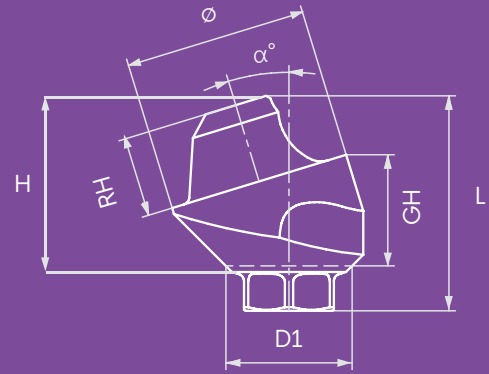





Our TMA™ (Trans Mucosal Abutment) system is indicated for multiple-unit, screw-retained restorations and may be used in combination with an implant level framework design.



The TMA™ system is used to elevate the restorative seating platform when restoration at implant level is not indicated or practical due to the depth or angle of the implant.



The TMA™ System is designed to allow better prosthetics access when using implants with divergent angles accommodate full and partial edentulous arches, especially when using angled implants and all-on-x technique for full arch restoration.



The TMA™ abutment system is available in straight or angled (17°,30°,45°), engaging the Internal Hex for indexing, with a selection of collar heights. Abutments are delivered with handles for easy insertion and to assist with seating.

TMA		L	Ø	D1	H	GH	RH	Catalog No.
	RS Straight Trans Mucosal Abutment	3.7	4.9	3.4	3.1	1	2.1	RS3731
	RS Straight Trans Mucosal Abutment	4.7	4.9	3.4	4.1	2	2.1	RS3732
	RS Straight Trans Mucosal Abutment	5.7	4.9	3.4	5.1	3	2.1	RS3733
	RS Straight Trans Mucosal Abutment	6.7	4.9	3.4	6.1	4	2.1	RS3729
	RS Straight Trans Mucosal Abutment	7.7	4.9	3.4	7.1	5	2.1	RS3730
	RS Angled Trans Mucosal Abutment 17°	5.17	4.9	3.4	-	2	2.1	RS3734
	RS Angled Trans Mucosal Abutment 17°	6.05	4.9	3.4	-	3	2.1	RS3737
	RS Angled Trans Mucosal Abutment 30°	5.7	4.9	3.4	-	3	2.1	RS3735
	RS Angled Trans Mucosal Abutment 30°	6.5	4.9	3.4	-	4	2.1	RS3738
	RS Angled Trans Mucosal Abutment 45°	5.94	4.9	3.4	-	4	2.1	RS3736





Transfers		L	∅	D1	D2	H	GH	RH	Catalog No.
	TMA Impression Transfer Open Tray	11	4.9	-	3.1	-	-	-	RS5006
	TMA Impression Transfer Closed Tray	8	4.9	-	4	-	-	-	RS5011

Scan Body		L	∅	D1	D2	H	GH	RH	Catalog No.
	TMA Scan Body	6	4.9	4.9	3.8	4.9	-	-	TM0006
		9	4.9	4.9	3.8	4.9	-	-	TM0009

TMA Abutment		L	∅	D1	D2	H	GH	RH	Catalog No.
	TMA Titanium Temporary Cylinder	12	4.9	-	3.5	-	1.5	10.5	RS4900
	TMA Plastic Casting Sleeve w/Prosthetic Screw	12	4.9	-	3.3	-	1.5	10.5	RS5001
	TMA Cementing Cone	4.9	4.9	-	2.9	-	1.5	3.4	TM0010

TMA Replica		L	∅	D1	D2	H	GH	RH	Catalog No.
	TMA Abutment Replica	16.75	4.9	-	3.6	-	-	-	RS5004
	TMA Digital Model Replica Recommended torque 15(Ncm)	12	4.9	-	3.8	-	-	-	RS1001

Healing Cap		L	∅	D1	D2	H	GH	RH	Catalog No.
	TMA Healing Cap	5.5	4.9	-	3.5	-	-	-	RS5005
		7.0	4.9	-	3.5	-	-	-	RS5003

Screws		L	∅	D1	D2	H	GH	RH	Catalog No.
	RS Retaining Screw For Angled TMA	6.1	2.4	-	-	-	-	-	RS3403
	TMA Prosthetic Screw <sup>15(Ncm)</sup>	4.1	2.1	-	-	-	-	-	RS3404
	RS Retaining Screw for TMA 1mm	7.8	3.1	-	-	-	-	-	RS3406
	RS Retaining Screw for TMA 2mm	8.8	3.1	-	-	-	-	-	RS3407
	RS Retaining Screw for TMA 3mm	9.8	3.1	-	-	-	-	-	RS3408
	RS Retaining Screw for TMA 4mm	10.8	3.1	-	-	-	-	-	RS3409
	RS Retaining Screw for TMA 5mm	11.8	3.1	-	-	-	-	-	RS3412
	TMA Screw For Open Tray Transfer	14	2.1	-	-	-	-	-	RS5008
	TMA Screw for Closed Tray Transfer	6.8	2.5	-	-	-	-	-	RS5009

### TMA/Flat connection drivers



TMA/FC Hex Torque Driver - Long

RS6196

\*For straight TMA/Flat connection



TMA/FC Hex Torque Driver - Short

RS6197

\*For straight TMA/Flat connection



Star Torque Driver-Long

RP0005

\*For Angled TMA/TMA prosthetic screw



Star Torque Driver-Short

RP0065

\*For Angled TMA/TMA prosthetic screw



TMA/FC Female Hand Hex Driver-Long

RS6191

\*For straight TMA/Flat connection



TMA/FC Female Hand Hex Driver-Short

RS6193

\*For straight TMA/Flat connection



Star Hand Driver-Long

RP0004

\*For Angled TMA/TMA prosthetic screw



Star Hand Driver-Short

RP0064

\*For Angled TMA/TMA prosthetic screw



TMA/FC Hex Handpiece Adapter-Long

RS6195A

\*For straight TMA/Flat connection



TMA/FC Hex Handpiece Adapter-Short

RS6194

\*For straight TMA/Flat connection



# Screw - Retained

## Flat Connection Recommended Torque 35(Ncm)

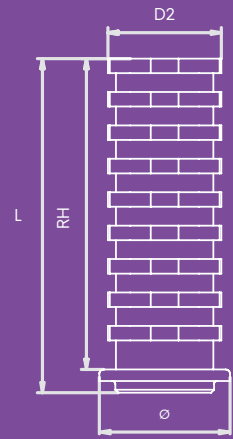

		L	Ø	D1	D2	H	GH	RH	Catalog No.
	Flat Connection Abutment	6.5	4.5	3.4	-	2	2	0	FC4502
	Flat Connection Abutment	8.5	4.5	3.4	-	4	4	0	FC4504
	Flat Connection Transfer Impression Coping	11	4.5	-	4.2	-	-	10.2	FC5512
	Flat Connection Temporary Cylinder Sleeve	11.5	4.5	-	3.9	11.1	0.4	10.7	FC5515
	Flat Connection Implant Replica	12.6	4.5	-	3.4	-	-	-	FC5737
	Flat Connection Castable Abutment for Centering Ring	13.6	4.6	-	3	13.6	0.1	13.5	FC6011
	Flat Connection Centering Ring	3.8	4.5	-	3.2	3.4	0.6	2.8	FC6018
	Flat Connection Titanium Gluing Ring	3.8	4.5	-	3.1	3.4	0.6	2.8	FC6013
	Flat Connection Titanium Retaining Screw 15(Ncm)	5	2.5	-	-	-	-	-	FC6015
	Flat Connection Long Laboratory Screw	17	2.5	-	-	-	-	-	FC6017





## Tri-Step & Twist Step Surgical Drills



Our DLC (Diamond Like Carbon) Tri-Step/Twist Step Surgical Drills are uniquely designed and coated to improve the surgical drilling process.

Tri-Step & Twist-Step DLC drills simplify the cutting process, save time and minimize risks. Our improved DLC drill coating provides state-of-the-art hardness and slickness that increases lifespan of the drill, maintains sharpness for extended drilling and generates less heat, thereby reducing chances of heating the bone or complications arising from conventional drilling protocols.

The drills come in the following diameters: 2.0, 2.5, 2.8, 3.2, 3.6, 4.2, 4.6, 5.2, 5.6  
Specially designed for Adin's implants and suitable for their simple and convenient drilling protocol. They are clearly and conveniently marked and can be used with or without drill stops.











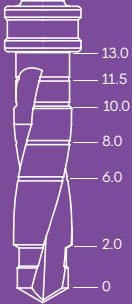







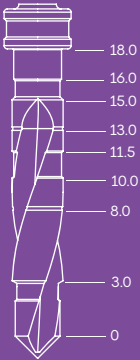

### Tri-Step drills

Adin's Tri-Step drills condense drilling protocols and avoid the need for using multiple drills throughout complex procedures.



Because friction at the cutting site is reduced, complications common with high speed drilling are decreased and faster & better recovery can occur.

L	Ø		Size	Catalog No.
	1.8-3.2		short	TD1511
	1.8-3.2		long	TD2218

## Twist Step drills

L	∅		Color	Catalog No.
<p>short</p>  <p>6-13mm</p>	2.0		white	DL1320
	1.8-2.5		purple	DL1325
	2.3-2.8		red	DL1328
	2.8-3.2		blue	DL1332
	3.2-3.6		green	DL1336
	3.8-4.2		black	DL1342
	4.2-4.6		yellow	DL1346
	4.8-5.2		brown	DL1352
	5.2-5.6		grey	DL1356
<p>long</p>  <p>8-18mm</p>	2.0		white	DL1820
	1.8-2.5		purple	DL1825
	2.3-2.8		red	DL1828
	2.8-3.2		blue	DL1832
	3.2-3.6		green	DL1836
	3.8-4.2		black	DL1842
	4.2-4.6		yellow	DL1846
	4.8-5.2		brown	DL1852
	5.2-5.6		grey	DL1856



		Catalog No.
	Surgical Torque Ratchet 35-100 Ncm	RS6111
	Wrench Ratchet	RS6100
	Surgical Driver	RS7001



Depth Probe

RS6180





Wrench Ratchet  
Surgical Instruments Handle 17mm

RA0050



Drill Extension

RS9027



Parallel Pin 11mm

RS6150



Parallel Pin 16mm

RS6155



RS 2.4 Hex Torque Driver  
17mm

RS6011



RS 2.4 Hex Torque Driver  
27mm

RS6012



RS Hex Handpiece Adapter  
20mm

RS9020



RS Hex Handpiece Adapter  
25mm

RS9025



RS Hex Handpiece Adapter  
23.7 mm

RS9021



RS Hex Handpiece Adapter  
28.6 mm  
36 mm

RS9026  
RS9029



Ratchet



Prosthetic Torque Ratchet  
15-35 Ncm

RS6112



1.27 Hex Torque  
Driver 20.4mm

RS6080



1.27 Hex Torque  
Driver 25.4mm

RS6082



TMA/FC Hex  
Torque Driver 25mm

RS6196

\*For straight TMA/Flat connection



TMA/FC Hex Torque  
Driver 20mm

RS6197

\*For straight TMA/Flat connection



Star Torque  
Driver 20.4mm

RP0065

\*For Angeld TMA/TMA prosthetic screw



Star Torque  
Driver 25.4mm

RP0005

\*For Angeld TMA/TMA prosthetic screw



Torque Driver for Ball  
Attachment 14.4mm

RS6090

## Handpiece



1.27 Hex Driver for Handpiece  
30mm

RS9035



1.27 Hex Driver for  
Handpiece 25mm

RS9030



TMA/FC Hex Handpiece  
Adapter 25mm

RS6195A

\*For straight TMA/Flat connection



TMA/FC Hex Handpiece  
Adapter 20mm

RS6194

\*For straight TMA/Flat connection

## Hand drivers



1.27 Hex Hand Driver  
46.4mm

RS6097



1.27 Hex Hand Driver  
28.4mm

RS6094



1.27 Hex Hand Driver  
22.4mm

RS6095



TMA/FC Female Hand  
Hex Driver 28.4mm

RS6191

\*For straight TMA/Flat connection



TMA/FC Female Hand  
Hex Driver 22.4mm

RS6193

\*For straight TMA/Flat connection



Star Hand Driver  
23.4mm

RP0064

\*For Angeld TMA/TMA prosthetic screw



Star Hand Driver  
28.4mm

RP0004

\*For Angeld TMA/TMA prosthetic screw

## Retrieval Screw



RS Retrieval Screw For  
Abutments 15mm

RS3401

## Osteotomes



Osteotome Handle

HA0074

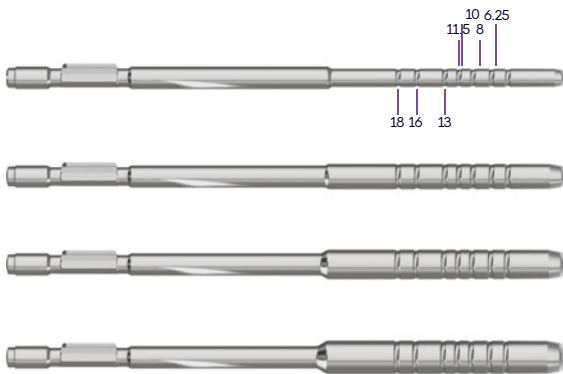

Osteotome Insert 2.0mmD

HA0061

Osteotome Insert 2.8mmD

HA0064

Osteotome Insert 3.25mmD

HA0067

Osteotome Insert 3.65mmD

HA0070









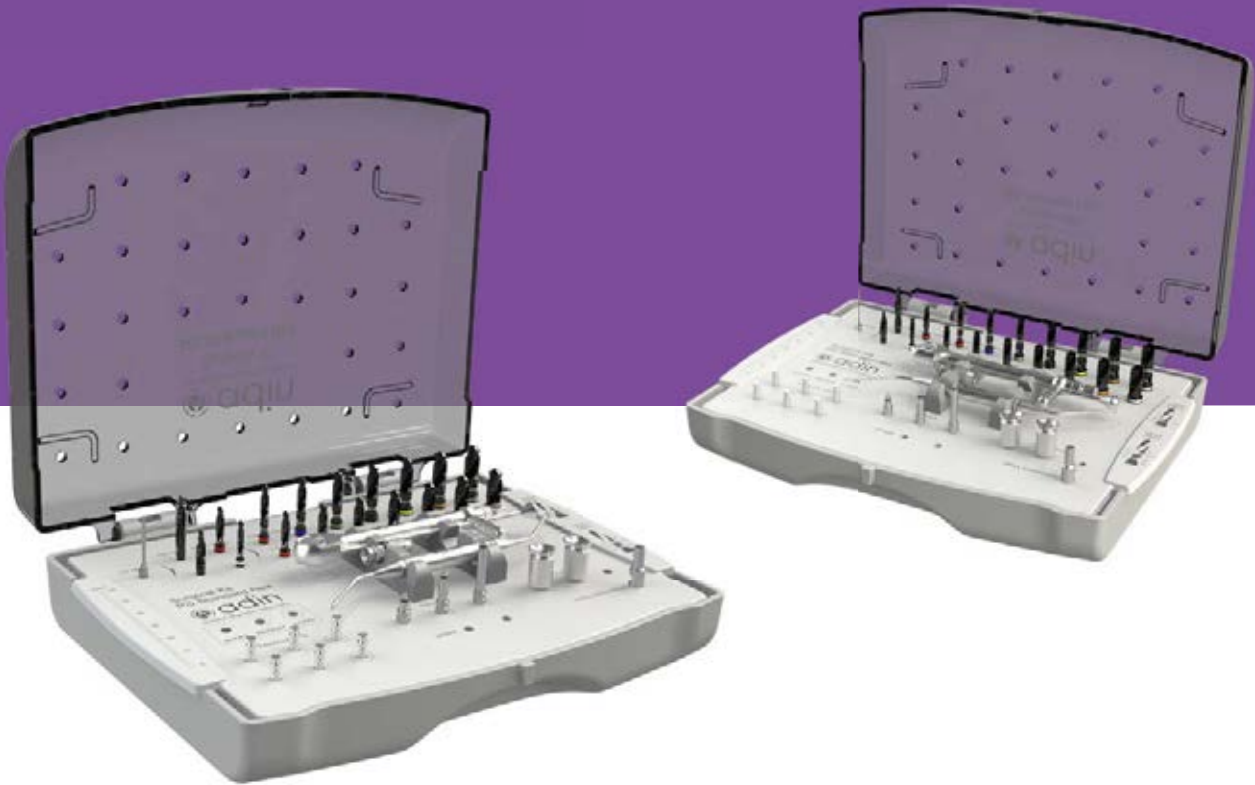



## Surgical Kits RS standard Hex



Successful surgical procedures start with having the right instruments and tools to ensure your desired treatment outcomes are met.

That's why our range has everything you need, including drills, keys, ratchets and insertion tools. Not only do they make procedures safer and simpler, they result in an enhanced patient experience as well.

Our Surgical Kits streamline and simplify your implant procedures.

Surgical Kit contents:			Premium RS6301	Advanced RS6322	Starter RS6333
	<b>Drills:</b>				
	RS8032	Tip Drill	✓		
	TD2218	Tri-Step Drill - Long	✓		
	DL1820	Pilot Drill 2mmD x 8-18mmL	✓	✓	✓
	DL1828	Twist Step Drill 2.3/2.8mmD x 8-18mmL	✓	✓	✓
	DL1832	Twist Step Drill 2.8/3.2mmD x 8-18mmL	✓	✓	✓
	DL1836	Twist Step Drill 3.2/3.6mmD x 8-18mmL	✓	✓	✓
	DL1842	Twist Step Drill 3.8/4.2mmD x 8-18mmL	✓	✓	✓
	DL1846	Twist Step Drill 4.2/4.6mmD x 8-18mmL	✓	✓	✓
	DL1852	Twist Step Drill 4.8/5.2mmD x 8-18mmL	✓		
* 	DL1856	Twist Step Drill 5.2/5.6mmD x 8-18mmL	*		
	TD1511	Tri-Step Drill - Short	✓		
	DL1320	Pilot Drill 2mmD x 6-13mmL	✓		
	DL1328	Twist Step Drill 2.3/2.8mmDx6-13mmL	✓		
	DL1332	Twist Step Drill 2.8/3.2mmDx6-13mmL	✓		
	DL1336	Twist Step Drill 3.2/3.6mmDx6-13mmL	✓		
	DL1342	Twist Step Drill 3.8/4.2mmDx6-13mmL	✓		
	DL1346	Twist Step Drill 4.2/4.6mmDx6-13mmL	✓		
	DL1352	Twist Step Drill 4.8/5.2mmDx6-13mmL	✓		
	DL1356	Twist Step Drill 5.2/5.6mmDx6-13mmL	✓		
	<b>Surgical tools:</b>				
	RS6111	Surgical Torque Ratchet 35-100 Ncm	✓	✓	
	RA0050	Wrench Ratchet Surgical Instruments Handle	✓	✓	✓
	RS6180	Depth Probe	✓	✓	
	RS6100	Wrench Ratchet			✓
	<b>Parallel pins:</b>				
	RS6150	Parallel Pin Short (qty. 4)	✓	✓	
	RS6155	Parallel Pin Long (qty. 2)	✓	✓	
	<b>Insertion tools:</b>				
	RS9021	RS Hex Handpiece Adapter - Short	✓	✓	✓
	RS9026	RS Hex Handpiece Adapter - Medium	✓	✓	✓
	RS9029	RS Hex Handpiece Adapter - Long	✓	✓	✓
	<b>Drivers:</b>				
	RS6095	1.27 Hex Hand Driver - Short	✓	✓	✓
	RS6094	1.27 Hex Hand Driver - Medium	✓	✓	✓
	<b>Drill extension:</b>				
	RS9027	Drill Extension	✓	✓	

\*Products may be ordered separately as an addition to the kit

# Premium Kit RS6301



Drills	Catalog No.
Tip Drill	RS8032
Tri-Step Drill - Long	TD2218
Pilot Drill 2mmD x 8-18mmL	DL1820
Twist Step Drill 2.3/2.8mmD x 8-18mmL	DL1828
Twist Step Drill 2.8/3.2mmD x 8-18mmL	DL1832
Twist Step Drill 3.2/3.6mmD x 8-18mmL	DL1836
Twist Step Drill 3.8/4.2mmD x 8-18mmL	DL1842
Twist Step Drill 4.2/4.6mmD x 8-18mmL	DL1846
Twist Step Drill 4.8/5.2mmD x 8-18mmL	DL1852
* Twist Step Drill 5.2/5.6mmD x 8-18mmL	DL1856
Tri-Step Drill - Short	TD1511
Pilot Drill 2mmD x 6-13mmL	DL1320
Twist Step Drill 2.3/2.8mmDx6-13mmL	DL1328
Twist Step Drill 2.8/3.2mmDx6-13mmL	DL1332
Twist Step Drill 3.2/3.6mmDx6-13mmL	DL1336
Twist Step Drill 3.8/4.2mmDx6-13mmL	DL1342
Twist Step Drill 4.2/4.6mmDx6-13mmL	DL1346
Twist Step Drill 4.8/5.2mmDx6-13mmL	DL1352
Twist Step Drill 5.2/5.6mmDx6-13mmL	DL1356

Surgical Tools	Catalog No.
Surgical Torque Ratchet 35-100 Ncm	RS6111
Wrench Ratchet Surgical Instruments Handle	RA0050
Depth Probe	RS6180

Paraller Pin	Catalog No.
Parallel Pin Short 11mm (qty. 4)	RS6150
Parallel Pin Long 16mm (qty. 2)	RS6155

Inserion Tools	Catalog No.
RS Hex Handpiece Adapter - Short	RS9021
RS Hex Handpiece Adapter - Medium	RS9026
RS Hex Handpiece Adapter - Long	RS9029

Paraller Pin	Catalog No.
1.27 Hex Hand Driver - Short	RS6095
1.27 Hex Hand Driver - Medium	RS6094

Drill Extension	Catalog No.
Drill Extension	RS9027

\*Products may be ordered separately as an addition to the kit



# Advanced Kit RS6322



Drills	Catalog No.
Pilot Drill 2mmD x 8-18mmL	DL1820
Twist Step Drill 2.3/2.8mmD x 8-18mmL	DL1828
Twist Step Drill 2.8/3.2mmD x 8-18mmL	DL1832
Twist Step Drill 3.2/3.6mmD x 8-18mmL	DL1836
Twist Step Drill 3.8/4.2mmD x 8-18mmL	DL1842
Twist Step Drill 4.2/4.6mmD x 8-18mmL	DL1846

Surgical Tools	Catalog No.
Surgical Torque Ratchet 35-100 Ncm	RS6111
Wrench Ratchet Surgical Instruments Handle	RA0050
Depth Probe	RS6180

Paraller Pin	Catalog No.
Parallel Pin Short 11mm(qty. 4)	RS6150
Parallel Pin Long 16mm (qty. 2)	RS6155

Inserion Tools	Catalog No.
RS Hex Handpiece Adapter - Short	RS9021
RS Hex Handpiece Adapter - Medium	RS9026
RS Hex Handpiece Adapter - Long	RS9029

Paraller Pin	Catalog No.
1.27 Hex Hand Driver - Short	RS6095
1.27 Hex Hand Driver - Medium	RS6094

Drill Extension	Catalog No.
Drill Extension	RS9027

\*The advanced kit is also available with short drills | Catalog No. RS6324

# Starter Kit RS6333



Drills	Catalog No.
Pilot Drill 2mmD x 8-18mmL	DL1820
Twist Step Drill 2.3/2.8mmD x 8-18mmL	DL1828
Twist Step Drill 2.8/3.2mmD x 8-18mmL	DL1832
Twist Step Drill 3.2/3.6mmD x 8-18mmL	DL1836
Twist Step Drill 3.8/4.2mmD x 8-18mmL	DL1842
Twist Step Drill 4.2/4.6mmD x 8-18mmL	DL1846

Surgical Tools	Catalog No.
Wrench Ratchet Surgical Instruments Handle	RA0050
Wrench Ratchet	RS6100

Insertion Tools	Catalog No.
RS Hex Handpiece Adapter - Short	RS9021
RS Hex Handpiece Adapter - Medium	RS9026
RS Hex Handpiece Adapter - Long	RS9029

Paraller Pin	Catalog No.
1.27 Hex Hand Driver - Short	RS6095
1.27 Hex Hand Driver - Medium	RS6094

\*The starter kit is also available with short drills | Catalog No. RS6334





The adinguide™ was created with you in mind, bringing the guided surgery world to your clinic. The kits were specifically designed to support effortless procedures, accurate and predictable implant placement.

The ActiveFlow™ Irrigation Technology' is a unique design that forces coolant through the guide to ensure irrigation reaches the bone and prevents overheating.

The adinguide™ drills are designed with carved channels which allow saline coolant from your hand-piece to stream through the sleeve directly into the osteotomy site while drilling.

Our uniquely designed drill kit is intuitive and easy to use by implant diameter and length. The Tissue Punch and Pilot Drill allow for easy flapless access.

Keyless procedure enables easy handling and full visibility of surgical field.

**Self-centering drills** – controlled by a 5.5mm diameter cylinder at the top of each drill centers the drill in the guide's sleeve.

**Self-centering cylinder** engages the sleeve before the drill engages the osteotomy in order to ensure correct positioning of the drill.

**Built-in stoppers** – ensure precise and accurate drilling to the desired depth.



# Guided Surgery Kit



## RS Touareg™, CloseFit™ RP/WP Implants Drills

GSK001



For full guided procedure:



RS Touareg™ S/OS  
Implant Platform



GS Tools Kit RS  
GSK003



5.5mmD Sleeve  
GS0055

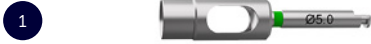

GS5055 Tissue Punch 5.0mmD, S-5.5



GS0625 Pilot Drill S-5.5, 2.5/1.8mmDx6.0mml



GS0825 Drill S-5.5, 2.5/1.8mmDx8.0mml



GS1025 Drill S-5.5, 2.5/1.8mmDx10.0mml



GS1125 Drill S-5.5, 2.5/1.8mmDx11.5mml



GS1325 Drill S-5.5, 2.5/1.8mmDx13.0mml



GS1625 Drill S-5.5, 2.5/1.8mmDx16.0mml

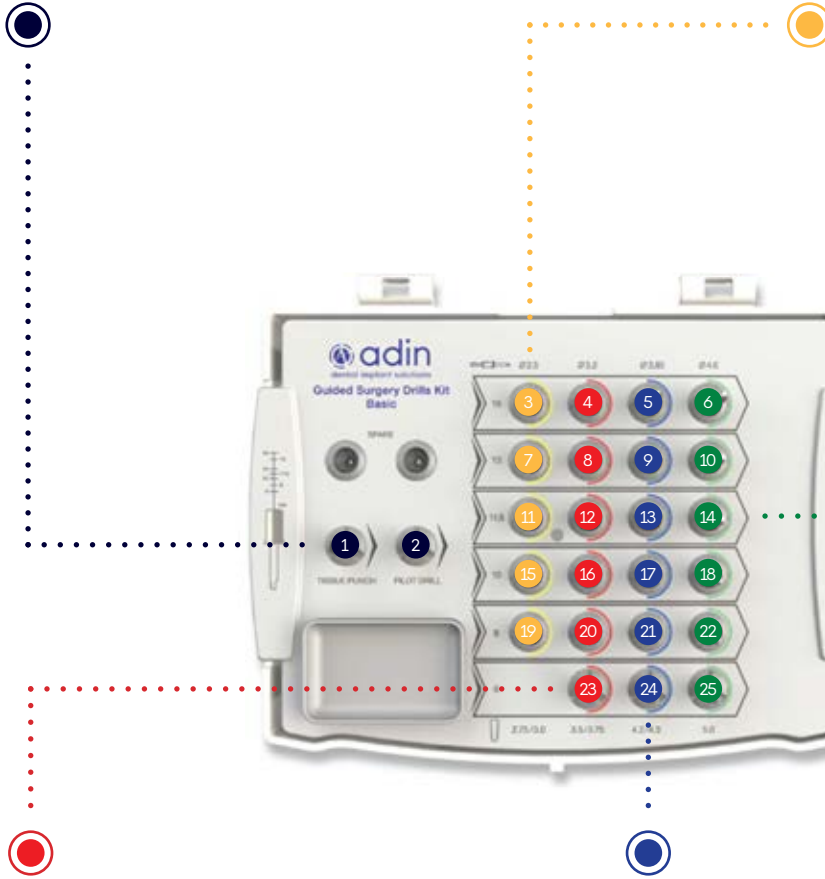

GS0632 Drill S-5.5, 3.2/2.5mmDx6.25mml



GS0638 Drill S-5.5, 3.85/3.2mmDx6.25mml



GS0646 Drill S-5.5, 4.6/3.85mmDx6.25mml



GS0832 Drill S-5.5, 3.2/2.5mmDx8.0mml



GS0838 Drill S-5.5, 3.85/3.2mmDx8.0mml



GS0846 Drill S-5.5, 4.6/3.85mmDx8.0mml



GS1032 Drill S-5.5, 3.2/2.5mmDx10.0mml



GS1038 Drill S-5.5, 3.85/3.2mmDx10.0mml



GS1046 Drill S-5.5, 4.6/3.85mmDx10.0mml



GS1132 Drill S-5.5, 3.2/2.5mmDx11.5mml



GS1138 Drill S-5.5, 3.85/3.2mmDx11.5mml



GS1146 Drill S-5.5, 4.6/3.85mmDx11.5mml



GS1332 Drill S-5.5, 3.2/2.5mmDx13.0mml



GS1338 Drill S-5.5, 3.85/3.2mmDx13.0mml



GS1346 Drill S-5.5, 4.6/3.85mmDx13.0mml



GS1632 Drill S-5.5, 3.2/2.5mmDx16.0mml



GS1638 Drill S-5.5, 3.85/3.2mmDx16.0mml



GS1646 Drill S-5.5, 4.6/3.85mmDx16.0mml



**Guided Surgery Kit**  
**RS Touareg™ Implants Tools**  
**GSK003**



For full guided procedure:



  
 RS Touareg™ S/OS  
 Implant Platform



GS Drill Kit  
**GSK001**



  
 5.5mmD Sleeve  
**GS0055**



GS0027 Guide Fixation Screw Driver



GS0010 Ratchet 4mm Hex



GS0035 RS Extraction Tool



GS0036 Extraction Tool Spanner

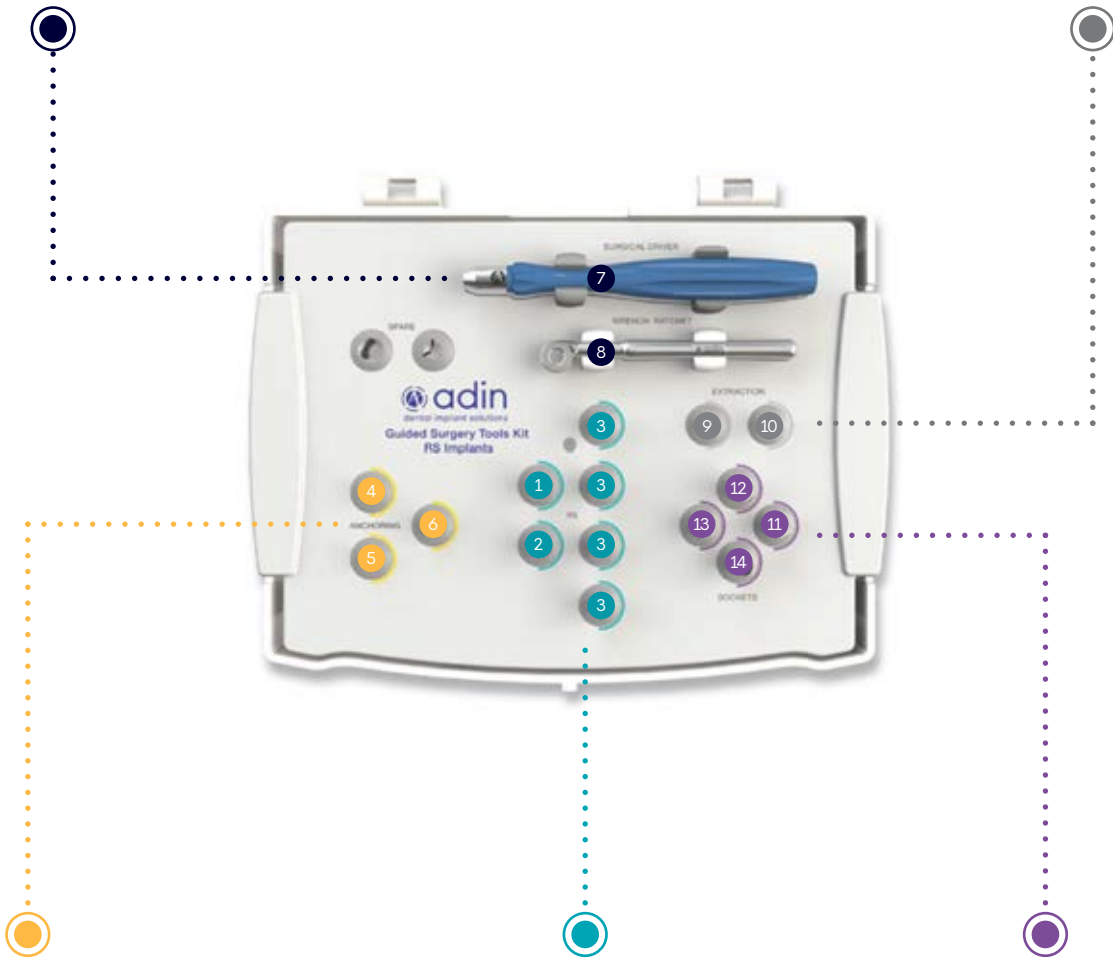

GS1917 Anchoring Drill S-2.0, 2.0/1.7mmDx19mmL



GS1915 Anchoring Drill S-2.0, 2.0/1.5mmDx19mmL



GS0028 Handpiece Guide Fixation Screw Driver



GS0032 RS Handpiece Fixture Mount



GS0034 RS Grip Fixture Mount



GS0029 RS Screw Fixture Mount



GS0023 Manual Socket L10.5



GS0024 Manual Socket L14.5



GS0021 Handpiece Socket L10.5



GS0022 Handpiece Socket L14.5



# Additional Products

Sold separately

## Accessories



2.0mmD Sleeve

Catalog No. GS0020



5.5mmD Sleeve

Catalog No. GS0055



Guided Vertical Fixation Screw S-3.3

Catalog No. GS0006



Guided Vertical Fixation Screw S-5.5

Catalog No. GS0007



2.0D 19mmL Anchorage Screw

Catalog No. GS1920

## Purchase Options

Catalog No.	Description	Package contents	
GS0006	Guided Vertical Fixation Screw S-3.3		x 3 pack
GS0007	Guided Vertical Fixation Screw S-5.5		x 3 pack
GS1920	2.0mmD Anchoring Screw		x 3 pack
GS0055	5.5mmD Sleeve		x 1 pack
GS0055x3			x 3 pack
GS0055x10			x 10 pack
GS0020	2.0mmD Anchoring Sleeve		x 3 pack



## 18mm Drills



Drill S-5.5, 2.5/1.8mmDx18.0mmL

Catalog No. GS1825



Drill S-5.5, 3.2/2.5mmDx18.0mmL

Catalog No. GS1832



Drill S-5.5, 3.85/3.2mmDx18.0mmL

Catalog No. GS1838



Drill S-5.5, 4.6/3.85mmDx18.0mmL

Catalog No. GS1846



Drill S-3.3, 2.5/1.8mmDx18.0mmL

Catalog No. GSN1825



Illustrations are not to scale  
Availability of the products in some places is limited and depends on local regulations.  
For more information, please contact your local representative.





# VA CAD CAM



Adin's CAD - CAM components and digital libraries enable dental clinicians and technicians to design and manufacture state-of-the-art restorations supported by Adin's implants, using current and up-to-date digital restoration processes.

The variety of components ensure endless restorative options for treatment of single, multiple, partially, or full edentulous cases.

Scan body (Implant level)

| For Intra-oral and Desktop Scanner

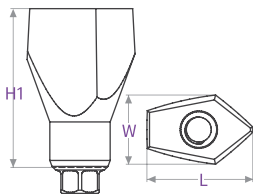

RS  
Scan Body 7mm

RS  
Scan Body 10mm



Catalog No.	RS0088	RS0089
Retaining Screw Included	RS3400	RS3425
Dimensions	H1:7 mm W:4.3 mm L:6.7 mm	H1:10 mm W:4.4 mm L:6.8 mm

Ti Bases

| For screw retained restorations

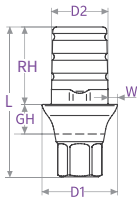

Catalog No.	RS1404	RS1408	RS1417
Abutment	Engaged	Non Engaged	Angular Engaged
Dimensions	L= 6.2   RH = 3.9 GH = 0.65   D2 = 3.3 W = 0.6	L= 6.2   RH = 3.9 GH = 0.65   D2 = 3.3 W = 0.6	L= 6.2   RH = 3.9 GH = 0.65   D2 = 3.3 W = 0.6

Ti Blanks

| For Medentika PreFace® Holders

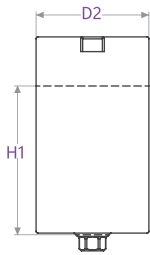

RS Ti Pre Milled  
MDTK Abutment Blank  
Ø 11.5mm

RS Ti Pre Milled  
MDTK Abutment Blank  
Ø 15.8mm



Catalog No.	RS1411	RS1415
Retaining Screw Included	RS3402	RS3402
Dimensions	H1: 15.2mm D2: Ø 11.5 mm	H1: 15.2mm D2: Ø 15.8 mm
Intended Use	customized abutment for single unit	customized abutment for single unit

Scan body (TMA level)

| For Intra-oral and Desktop Scanner

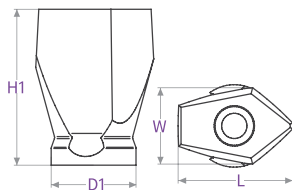

TMA  
Scan Body 6mm

TMA  
Scan Body 9mm



Catalog No.	TM0006	TM0009
Retaining Screw Included	TM0001	TM0001
Dimensions	H1: 6 mm   W:4.3 mm D1 = 4.9   L:6.7 mm	H1: 9 mm   W:4.4 mm D1 = 4.9   L:6.8 mm

TMA  
Cementing Cone

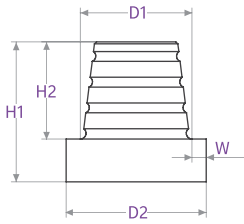

Titanium  
Temporary Cylinder

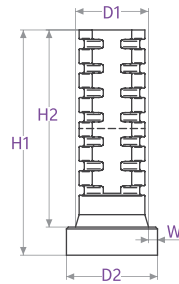

Catalog No.	TM0010	RS4900
Retaining Screw Included	TM0001	RS3404
Dimensions	H1: 4.9 mm H2:3.4 mm D1:∅3.8 mm D2:∅4.9 mm W: 0.5 mm	H1:12 mm H2:10.5 mm D1:∅3.9 mm D2:∅4.9 mm W:0.5 mm
Intended Use	customized abutment for single unit	customized abutment for single unit

RS Screws

Scan Body 7mm

Scan Body 10mm

For Ti Bases & Ti Blanks



Catalog No.	RS3400	RS3425	RS3402
Intended use	Prosthetic Screw	Screw for Closed Tray Transfer	Short Prosthetic Screw

TMA - Multi Unit Screws

TMA  
Scan Body Screw

TMA  
Prosthetic Screw



Catalog No.	TM0001	RS3404
Intended use	For TMA-MU Scan Body & Cementing Cone	For TMA-MU Temporary cylinder & TMA direct option



Digital Anlogs

RS Digital Analog

TMA Digital Replica

Retaining Screw



Catalog No.

RS1000

RS1001

RS1002

Tool driver

1.27 Hex Hand Driver Short

1.27 Hex Hand Driver Medium



Catalog No.

RS6095

RS6094







## Ti Bases (coming soon)

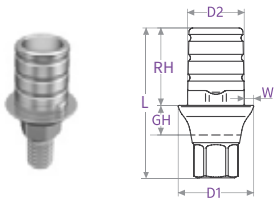

Engaged	RH	GH	D1	D2	L	W	Catalog No.
Ti Base RS Abutment, RH 4mm GH 1mm Engaged	4	1	4.5	3.5	6.65	0.5	TB04411
Ti Base RS Abutment, RH 4mm GH 2mm Engaged	4	2	4.5	3.5	7.65	0.5	TB04421
Ti Base RS Abutment, RH 4mm GH 3mm Engaged	4	3	4.5	3.5	8.65	0.5	TB04431
Ti Base RS Abutment, RH 4mm GH 4mm Engaged	4	4	4.5	3.5	9.65	0.5	TB04441
Ti Base RS Abutment, RH 6mm GH 1mm Engaged	6	1	4.5	3.5	8.65	0.5	TB04611
Ti Base RS Abutment, RH 6mm GH 2mm Engaged	6	2	4.5	3.5	9.65	0.5	TB04621
Ti Base RS Abutment, RH 6mm GH 3mm Engaged	6	3	4.5	3.5	10.65	0.5	TB04631
Ti Base RS Abutment, RH 6mm GH 4mm Engaged	6	4	4.5	3.5	11.65	0.5	TB04641
Ti Base RS Abutment, RH 8mm GH 1mm Engaged	8	1	4.5	3.5	10.65	0.5	TB04811
Ti Base RS Abutment, RH 8mm GH 2mm Engaged	8	2	4.5	3.5	11.65	0.5	TB04821
Ti Base RS Abutment, RH 8mm GH 3mm Engaged	8	3	4.5	3.5	12.65	0.5	TB04831
Ti Base RS Abutment, RH 8mm GH 4mm Engaged	8	4	4.5	3.5	13.65	0.5	TB04841

Engaged Wide	RH	GH	D1	D2	L	W	Catalog No.
Ti Base RS Abutment, RH 4mm GH 1mm Engaged Wide	4	1	5.5	3.5	6.65	1	TB04411W
Ti Base RS Abutment, RH 4mm GH 2mm Engaged Wide	4	2	5.5	3.5	7.65	1	TB04421W
Ti Base RS Abutment, RH 4mm GH 3mm Engaged Wide	4	3	5.5	3.5	8.65	1	TB04431W
Ti Base RS Abutment, RH 4mm GH 4mm Engaged Wide	4	4	5.5	3.5	9.65	1	TB04441W
Ti Base RS Abutment, RH 6mm GH 1mm Engaged Wide	6	1	5.5	3.5	8.65	1	TB04611W
Ti Base RS Abutment, RH 6mm GH 2mm Engaged Wide	6	2	5.5	3.5	9.65	1	TB04621W
Ti Base RS Abutment, RH 6mm GH 3mm Engaged Wide	6	3	5.5	3.5	10.65	1	TB04631W

Ti Base RS Abutment, RH 6mm GH 4mm Engaged Wide	6	4	5.5	3.5	11.65	1	TB04641W
Ti Base RS Abutment, RH 8mm GH 1mm Engaged Wide	8	1	5.5	3.5	10.65	1	TB04811W
Ti Base RS Abutment, RH 8mm GH 2mm Engaged Wide	8	2	5.5	3.5	11.65	1	TB04821W
Ti Base RS Abutment, RH 8mm GH 3mm Engaged Wide	8	3	5.5	3.5	12.65	1	TB04831W
Ti Base RS Abutment, RH 8mm GH 4mm Engaged Wide	8	4	5.5	3.5	13.65	1	TB04841W

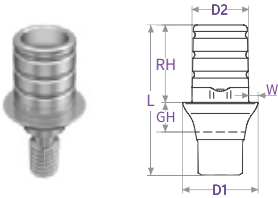

Non Engaged	RH	GH	D1	D2	L	W	Catalog No.
Ti Base RS Abutment, RH 4mm GH 1mm Non Engaged	4	1	4.5	3.5	6	0.5	TB04412
Ti Base RS Abutment, RH 4mm GH 2mm Non Engaged	4	2	4.5	3.5	7	0.5	TB04422
Ti Base RS Abutment, RH 4mm GH 3mm Non Engaged	4	3	4.5	3.5	8	0.5	TB04432
Ti Base RS Abutment, RH 4mm GH 4mm Non Engaged	4	4	4.5	3.5	9	0.5	TB04442
Ti Base RS Abutment, RH 6mm GH 1mm Non Engaged	6	1	4.5	3.5	8	0.5	TB04612
Ti Base RS Abutment, RH 6mm GH 2mm Non Engaged	6	2	4.5	3.5	9	0.5	TB04622
Ti Base RS Abutment, RH 6mm GH 3mm Non Engaged	6	3	4.5	3.5	10	0.5	TB04632
Ti Base RS Abutment, RH 6mm GH 4mm Non Engaged	6	4	4.5	3.5	11	0.5	TB04642
Ti Base RS Abutment, RH 8mm GH 1mm Non Engaged	8	1	4.5	3.5	10	0.5	TB04812
Ti Base RS Abutment, RH 8mm GH 2mm Non Engaged	8	2	4.5	3.5	11	0.5	TB04822
Ti Base RS Abutment, RH 8mm GH 3mm Non Engaged	8	3	4.5	3.5	12	0.5	TB04832
Ti Base RS Abutment, RH 8mm GH 4mm Non Engaged	8	4	4.5	3.5	13	0.5	TB04842

Non Engaged Wide	RH	GH	D1	D2	L	W	Catalog No.
Ti Base RS Abutment, RH 4mm GH 1mm Non Engaged Wide	4	1	5.5	3.5	6	1	TB04412W
Ti Base RS Abutment, RH 4mm GH 2mm Non Engaged Wide	4	2	5.5	3.5	7	1	TB04422W
Ti Base RS Abutment, RH 4mm GH 3mm Non Engaged Wide	4	3	5.5	3.5	8	1	TB04432W
Ti Base RS Abutment, RH 4mm GH 4mm Non Engaged Wide	4	4	5.5	3.5	9	1	TB04442W
Ti Base RS Abutment, RH 6mm GH 1mm Non Engaged Wide	6	1	5.5	3.5	8	1	TB04612W
Ti Base RS Abutment, RH 6mm GH 2mm Non Engaged Wide	6	2	5.5	3.5	9	1	TB04622W
Ti Base RS Abutment, RH 6mm GH 3mm Non Engaged Wide	6	3	5.5	3.5	10	1	TB04632W
Ti Base RS Abutment, RH 6mm GH 4mm Non Engaged Wide	6	4	5.5	3.5	11	1	TB04642W

Ti Base RS Abutment, RH 8mm GH 1mm Non Engaged Wide	8	1	5.5	3.5	10	1	TB04812W
Ti Base RS Abutment, RH 8mm GH 2mm Non Engaged Wide	8	2	5.5	3.5	11	1	TB04822W
Ti Base RS Abutment, RH 8mm GH 3mm Non Engaged Wide	8	3	5.5	3.5	12	1	TB04832W
Ti Base RS Abutment, RH 8mm GH 4mm Non Engaged Wide	8	4	5.5	3.5	13	1	TB04842W

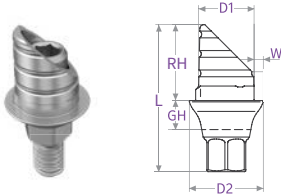

Angular Engaged	RH	GH	D1	D2	L	W	Catalog No.
Ti Base RS Abutment, RH 4mm GH 1mm Angular Engaged	4	1	4.5	3.5	6.65	0.5	TB04413
Ti Base RS Abutment, RH 4mm GH 2mm Angular Engaged	4	2	4.5	3.5	7.65	0.5	TB04423
Ti Base RS Abutment, RH 4mm GH 3mm Angular Engaged	4	3	4.5	3.5	8.65	0.5	TB04433
Ti Base RS Abutment, RH 4mm GH 4mm Angular Engaged	4	4	4.5	3.5	9.65	0.5	TB04443
Ti Base RS Abutment, RH 6mm GH 1mm Angular Engaged	6	1	4.5	3.5	8.65	0.5	TB04613
Ti Base RS Abutment, RH 6mm GH 2mm Angular Engaged	6	2	4.5	3.5	9.65	0.5	TB04623
Ti Base RS Abutment, RH 6mm GH 3mm Angular Engaged	6	3	4.5	3.5	10.65	0.5	TB04633
Ti Base RS Abutment, RH 6mm GH 4mm Angular Engaged	6	4	4.5	3.5	11.65	0.5	TB04643
Ti Base RS Abutment, RH 8mm GH 1mm Angular Engaged	8	1	4.5	3.5	10.65	0.5	TB04813
Ti Base RS Abutment, RH 8mm GH 2mm Angular Engaged	8	2	4.5	3.5	11.65	0.5	TB04823
Ti Base RS Abutment, RH 8mm GH 3mm Angular Engaged	8	3	4.5	3.5	12.65	0.5	TB04833
Ti Base RS Abutment, RH 8mm GH 4mm Angular Engaged	8	4	4.5	3.5	13.65	0.5	TB04843

Angular Engaged Wide	RH	GH	D1	D2	L	A	W	Catalog No.
Ti Base RS Abutment, RH 4mm GH 1mm Angular Engaged Wide	4	1	5.5	3.5	6.65	45	1	TB04413W
Ti Base RS Abutment, RH 4mm GH 2mm Angular Engaged Wide	4	2	5.5	3.5	7.65	45	1	TB04423W
Ti Base RS Abutment, RH 4mm GH 3mm Angular Engaged Wide	4	3	5.5	3.5	8.65	45	1	TB04433W
Ti Base RS Abutment, RH 4mm GH 4mm Angular Engaged Wide	4	4	5.5	3.5	9.65	45	1	TB04443W
Ti Base RS Abutment, RH 6mm GH 1mm Angular Engaged Wide	6	1	5.5	3.5	8.65	35	1	TB04613W
Ti Base RS Abutment, RH 6mm GH 2mm Angular Engaged Wide	6	2	5.5	3.5	9.65	35	1	TB04623W
Ti Base RS Abutment, RH 6mm GH 3mm Angular Engaged Wide	6	3	5.5	3.5	10.65	35	1	TB04633W
Ti Base RS Abutment, RH 6mm GH 4mm Angular Engaged Wide	6	4	5.5	3.5	11.65	35	1	TB04643W
Ti Base RS Abutment, RH 8mm GH 1mm Angular Engaged Wide	8	1	5.5	3.5	10.65	25	1	TB04813W
Ti Base RS Abutment, RH 8mm GH 2mm Angular Engaged Wide	8	2	5.5	3.5	11.65	25	1	TB04823W
Ti Base RS Abutment, RH 8mm GH 3mm Angular Engaged Wide	8	3	5.5	3.5	12.65	25	1	TB04833W
Ti Base RS Abutment, RH 8mm GH 4mm Angular Engaged Wide	8	4	5.5	3.5	13.65	25	1	TB04843W

# Conical Connection





## Conical Connection CloseFit™

When you're seeking to minimize micro movements between the dental implant and the abutment and to reduce potential bone loss, you'll benefit from Adin's CloseFit™ spiral implant system, which features an extremely strong, stable and solid conical-hex connection.

The CloseFit's tapered core implant includes a multi lead active & dynamic thread design.

The unique design of the implant is suited for optimal repositioning at diverse angles within the lower and upper jaw. Designed for Subcrestal placement up to 1.0 - 2.0mm.

The CloseFit™ implants feature Adin's OsseoFix™ - A biocompatible surface treatment that uses gritting with Calcium Phosphate media that is debris free and has been designed to achieve the desired roughness levels needed for optimal osseointegration.



CloseFit™

# Narrow Implants

With more than 10 years of proven clinical experience, these uniquely designed small diameter implants of 2.75mm & 3.0mm, have an especially narrow body & collar to provide a perfect solution that addresses narrow ridges in atrophic jaws for exceptional esthetic's results.

The strong Conical Connection designed to minimize micro movements.



**UNP CloseFit™**  
Ø 2.75mmD  
Ultra Narrow Platform

**NP CloseFit™**  
Ø 3.0mmD  
Narrow Platform

\* Optimally designed for narrow ridges, minimize the need of bone augmentation

\* **OsseoFix™**

\* **Double lead threads**  
2.4mm (2x1.2)  
For fast efficient insertion

\* **Platform Switching**

\* **Micro Threads:**  
Engineered to enhance bone regeneration, prevent bone loss & increase bone implant contact

Triple lead thread with 3.0mm (3x1)  
For fast efficient insertion

\* **Length**

L-10mm | L-11.5mm | L-13 mm  
L-16mm | L-18 mm

\*The features related to NP & UNP Implants



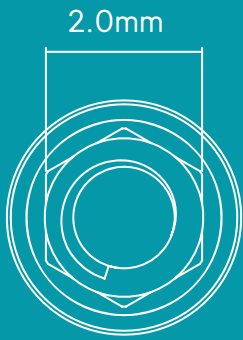

# NP CloseFit™

Narrow Platform

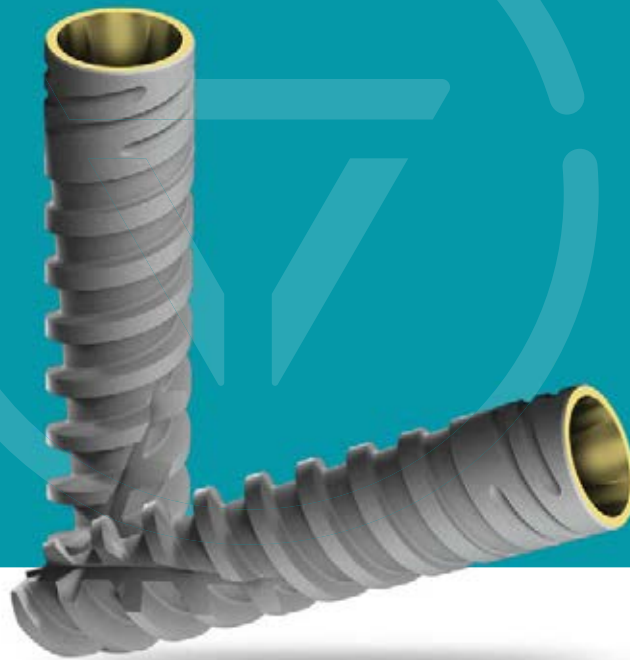

Recommended insertion torque up to 50 Ncm

CloseFit™ NP	Ø	L	D3	Catalog No.
	3.0	10.0	2.3	ISPNP1030
		11.5	2.2	ISPNP1130
		13.0	2.2	ISPNP1330
		16.0	2.15	ISPNP1630
		18.0	2.1	ISPNP1830

Radiographic Template NP CloseFit™ | ASD0611

## Drill Sequence

Recommended drilling speed up to 1200 rpm

Implant Diameter  $\varnothing 3.0$   $\varnothing 3.0$

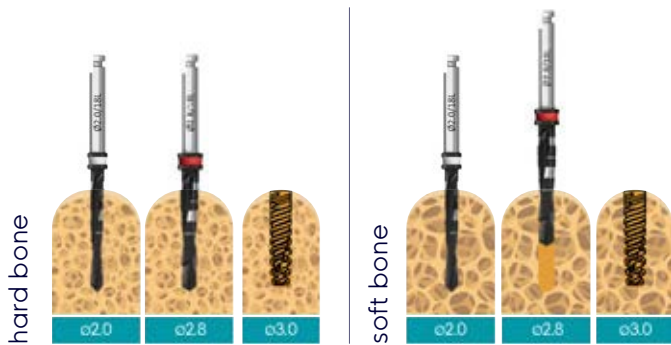

All measurements are in mm.

## Cover Screw & Healing Abutments Recommended Torque 15(Ncm)

### NP CloseFit™ Conical Cover Screw



NP0073

### NP CloseFit™ Slim Healing Abutment

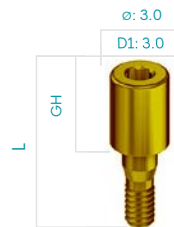

NP0046, GH2/L6.6

NP0047, GH3/L7.6

NP0048, GH4/L8.6

NP0049, GH5/L9.6

NP0050, GH6/L10.6

### NP CloseFit™ Healing Abutment

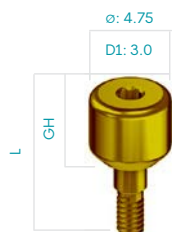

NP0004, GH2/L6.5

NP0008, GH3/L7.5

NP0009, GH4/L8.5

NP0012, GH5/L9.5

NP0013, GH6/L10.5

### NP CloseFit™ Conical Healing Abutment



NP0090, GH2/L6.9

NP0091, GH3/L7.9

NP0092, GH4/L8.9

NP0093, GH5/L9.9

NP0094, GH6/L10.9



## NP™ Impression

Recommended Torque 15(Ncm)

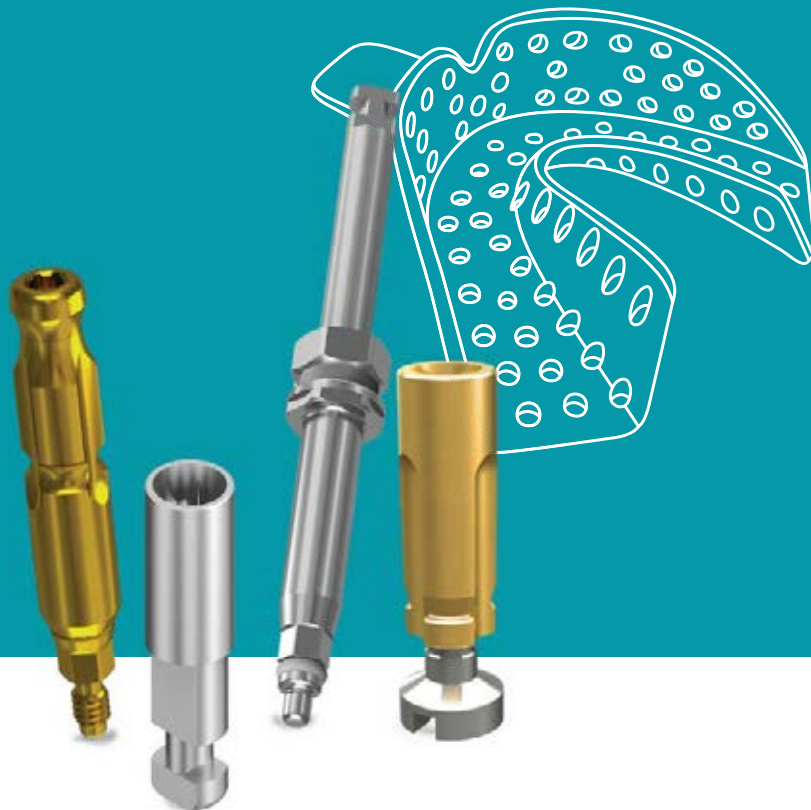

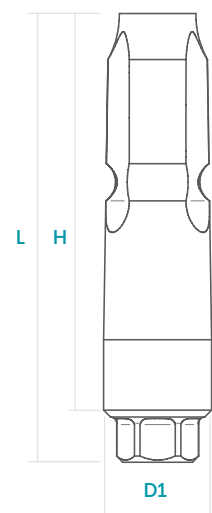

Our components for taking impressions for all restoration types can be successfully utilized for digital or conventional protocols either implant-level or abutment level procedures.

Our broad range of solutions and flexible designs enable easy and accurate restorative planning, whether you're dealing with a single tooth, multiple teeth, bridge or full mouth rehabilitation.



Transfers		L	Ø	D1	H	GH	RH	Catalog No.
	NP Slim Closed Tray Transfer	15.2	3.2	2.5	13.0	-	-	NP5113
	NP Closed Tray Transfer	15.2	4.3	2.5	13.0	-	-	NP5213
	NP Slim Open Tray Transfer	18.0	5.0	2.5	14.0	-	-	NP5614
	NP Open Tray Transfer	18.0	6.0	2.5	14.0	-	-	NP5514
	NP Scan Body	9.2	-	2.5	7.0	-	-	NP0088
		12.2	-	2.5	10.0	-	-	NP0089

Analog/Digital Analog		L	Ø	D1	H	GH	RH	Catalog No.
	NP Implant Analog	12.6	3.0	2.5	-	-	-	NP0007
	NP digital analog 15(Ncm)	10.0	3.55	3.4	-	-	-	NP1000



# Cement Retained Abutments

Recommended Torque 35(Ncm)

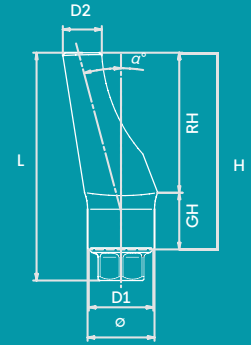

Abutments	L	Ø	D1	D2	H	GH	RH	Catalog No.
 NP Straight Slim Abutment No End Line	11.0	3.5	2.5	3.0	8.8	3.2	5.7	NP0010
 NP Straight Abutment	9.7	4.4	2.5	3.0	7.5	1.0	6.5	NP0019
	10.7	4.4	2.5	3.0	8.5	2.0	6.5	NP0011
	11.7	4.4	2.5	3.0	9.5	3.0	6.5	NP0064
 NP Angled Abutment 15° No End Line	11.7	4.3	2.5	1.9	9.5	1.4	8.2	NP0018
 NP Angled Abutment 15°	9.7	4.8	2.5	2.4	7.5	1.0	6.5	NP0015
	10.7	4.8	2.5	2.4	8.5	2.0	6.5	NP0026
	11.7	4.8	2.5	2.4	9.5	3.0	6.5	NP0063
 NP Angled Abutment 25° No End Line	10.0	3.8	2.5	1.9	7.8	1.6	6.5	NP0025
 NP Engaging Temporary Abutment	11.0	3.7	2.5	3.2	8.8	0.7	8.0	NP0043
 NP Non-Engaging Temporary Abutment	11.0	3.7	2.5	3.2	8.8	0.7	8.0	NP0044
 NP Engaging Plastic Cylinder Abutment (Casting)	11.0	3.7	2.5	3.0	8.8	0.7	8.0	NP0045
 NP Engaging Titanium / Plastic Abutment (Casting)	13.2	4.2	2.5	4.2	11.0	1.0	10.0	NP3095
	13.2	4.2	2.5	4.2	11.0	1.0	10.0	NP3097



## TMA™ - Multi Unit

Recommended Torque 35(Ncm)

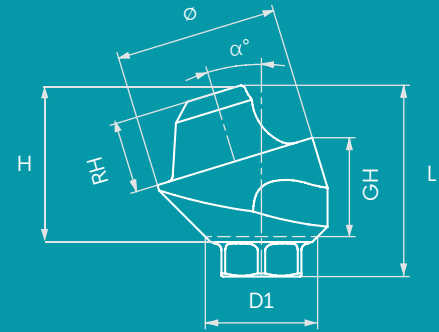











Our TMA™ (Trans Mucosal Abutment) system is indicated for multiple-unit, screw-retained restorations and may be used in combination with an implant level framework design.

The TMA™ system is used to elevate the restorative seating platform when restoration at implant level is not indicated or practical due to the depth or angle of the implant.

The TMA™ System is designed to allow better prosthetics access when using implants with divergent angles accommodate full and partial edentulous arches, especially when using angled implants and all-on-x technique for full arch restoration.

The TMA™ abutment system is available in straight or angled (17°, 30°, 45°), engaging the Conical Connection for indexing, with a selection of collar heights. Abutments are delivered with handles for easy insertion and to assist with seating.

TMA		L	Ø	D1	D2	H	GH	RH	Catalog No.
	NP Straight Trans Mucosal Abutment	4.2	4.9	2.5	-	2.0	1.0	2.10	NP0032
		5.2	4.9	2.5	-	3.0	2.0	2.10	NP0033
		6.2	4.9	2.5	-	4.0	3.0	2.10	NP0034
		7.2	4.9	2.5	-	5.0	4.0	2.10	NP3729
		8.2	4.9	2.5	-	6.0	5.0	2.10	NP3730
	NP Angled Trans Mucosal Abutment 17°	6.8	4.9	2.5	-	-	2.8	2.15	NP0035
	NP Angled Trans Mucosal Abutment 17°	7.9	4.9	2.5	-	-	3.9	2.15	NP0038
	NP Angled Trans Mucosal Abutment 30°	6.9	4.9	2.5	-	-	3.5	2.15	NP0036
	NP Angled Trans Mucosal Abutment 30°	8.1	4.9	2.5	-	-	4.9	2.15	NP0037

TMA components		L	∅	D1	D2	H	GH	RH	Catalog No.
	TMA Healing Cap	5.5	4.9	-	3.5	-	-	-	RS5005
		7	4.9	-	3.5	-	-	-	RS5003
	TMA Impression Coping Open Tray	11.0	4.9	-	3.1	-	-	-	RS5006
	TMA Closed Tray Transfer	8.0	4.9	-	4.0	-	-	-	RS5011
	TMA Scan Body	6	4.9	4.9	3.8	4.9	-	-	TM0006
		9	4.9	4.9	3.8	4.9	-	-	TM0009
	TMA Titanium Temporary Cylinder	12.0	4.9	-	3.5	-	1.5	10.5	RS4900
	TMA Cementing Cone	4.9	4.9	-	2.9	-	1.5	3.4	TM0010
	TMA Plastic Casting Sleeve w/ Prosthetic Screw	12.0	4.9	-	3.3	-	1.5	10.5	RS5001
	TMA Abutment Replica	16.8	4.9	-	1.7	-	-	-	RS5004
	TMA Digital Model Replica Recommended torque 15(Ncm)	12	4.9	-	3.8	-	-	-	RS1001







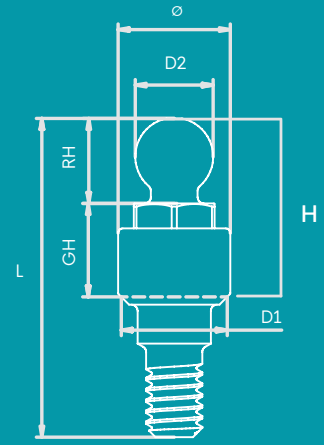

# Overdenture Restoration

Recommended Torque 35(Ncm)



Ball Attachment		L	Ø	D1	D2	H	GH	RH	Catalog No.
	NP Ball Attachment	8.8	2.9	2.5	2.5	4.1	0.5	3.5	NP0020
		9.2	2.9	2.5	2.5	4.5	1.0	3.5	NP0021
		10.2	2.9	2.5	2.5	5.5	2.0	3.5	NP0022
		11.2	2.9	2.5	2.5	6.5	3.0	3.5	NP0023
		12.2	2.9	2.5	2.5	7.5	4.0	3.5	NP0024

Ball Attachment caps		L	Ø	D1	D2	H	GH	RH	Catalog No.
	Plastic Ball Cap White (Nylon)	2.60	4.10	-	3.60	-	-	-	RS2660
	Plastic Ball Cap Pink Soft (Nylon)	2.60	4.10	-	3.60	-	-	-	RS2662
	Titanium Ball Cap	2.90	4.70	-	4.70	-	-	-	RS2670
	Stainless Steel Ball Cap	2.90	4.70	-	4.70	-	-	-	RS2675SS

Ball Attachment		L	Ø	D1	D2	H	GH	RH	Catalog No.
	Ball Attachment Abutment Replica	16.60	4.00	-	2.5	-	0.80	2.7	RS5740







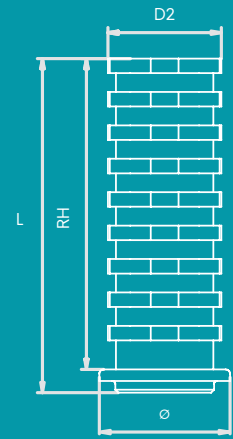

# Screw - Retained

Recommended Torque 35(Ncm)



Flat Connection	L	Ø	D1	D2	H	GH	RH	Catalog No.
	7.3	4.5	2.5	-	2.0	2.0	-	NP0030
NP Flat Connection Abutment	8.8	4.5	2.5	-	2.0	4.0	-	NP0031
	11.5	4.5	-	3.9	11.1	0.4	10.7	FC5515
Flat Connection Implant Replica	12.6	4.5	-	3.4	-	-	-	FC5737
	13.6	4.6	-	3.0	13.6	0.1	13.5	FC6011
Flat Connection Titanium Retaining Screw	5.0	2.5	-	-	-	-	-	FC6015
	3.8	4.5	-	3.1	3.4	0.6	2.8	FC6013
Flat Connection Long Laboratory Screw	17.0	2.5	-	-	-	-	-	FC6017
	3.8	4.5	-	3.2	3.4	0.6	2.8	FC6018
	11.0	4.5	-	4.2	-	-	10.2	FC5512

Screws		L	Ø	Catalog No.
	NP Abutment Screw	7.9	2.0	NP0001
	TMA Prosthetic Screw 15(Ncm)	4.1	2.1	RS3404
	NP Retaining Screw for Angled TMA	7.1	2.0	NP0042
	NP Retaining Screw for TMA 1mm	8.0	3.1	NP0039
	NP Retaining Screw for TMA 2mm	9.0	3.1	NP0040
	NP Retaining Screw for TMA 3mm	10.0	3.1	NP0041
	NP Retaining Screw for TMA 4mm	11.0	3.1	NP3409
	NP Retaining Screw for TMA 5mm	12.0	3.1	NP3412
	NP Open Tray Transfer Screw	28.0	3.1	NP5014
	NP Closed Tray Transfer Screw	20.0	2.8	NP5127
	NP Retrieval Screw for Abutments	13.4	2.0	NP0014



# Hand & Torque Drivers

Recommended Torque 35(Ncm)



Star Hand Driver  
23.4mm RP0064

\*For Angeld TMA/TMA prosthetic screw



Star Hand Driver  
23.4mm RP0004

\*For Angeld TMA/TMA prosthetic screw



TMA/FC Female  
Hand Hex Driver  
22.4mm RS6193

\*For straight TMA/Flat connection



TMA/FC Female  
Hand Hex Driver  
28.4mm RS6191

\*For straight TMA/Flat connection



Wrench Ratchet  
Surgical Instruments  
Handle 16.7mm RA0050



UNP/NP Abutment  
insertion tool 25.9mm UNP1001



NP 2mm Hex  
Torque Driver  
17mm NP0006



NP 2mm Hex  
Torque Driver  
27mm NP0005



Star Torque Driver  
20.4mm RP0065

\*For Angeld TMA/TMA prosthetic screw



Star Torque  
Driver  
25.4mm RP0005

\*For Angeld TMA/TMA prosthetic screw



Torque Driver for  
Ball Attachment  
24.4mm RS6090



TMA/FC Hex Torque  
Driver 20mm RS6197

\*For straight TMA/Flat connection



TMA/FC Hex  
Torque Driver  
25mm RS6196

\*For straight TMA/Flat connection



# Handpiece Drivers

Recommended Torque 35(Ncm)



NP 2mm Hex Handpiece Adapter 23.7mm

NP0068



NP 2mm Hex Handpiece Adapter 27.7mm

NP0071



NP 2mm Hex Handpiece Adapter 36mm

NP0074



NP 2mm Hex Handpiece Adapter 20mm

NP0062



NP 2mm Hex Handpiece Adapter 25mm

NP0072



Star Handpiece Driver 25mm

RP0018

\*For Angeld TMA/TMA prosthetic screw



Star Handpiece Drive 30mm

RP0019



TMA/FC Hex Handpiece Adapter 20mm

RS6194

\*For Angeld TMA/TMA prosthetic screw



TMA/FC Hex Handpiece Adapter 25mm

RS6195A

\*For straight TMA/Flat connection



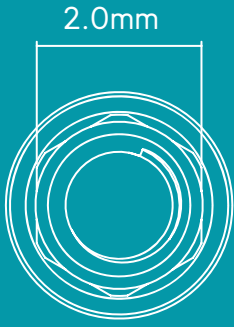

# UNP CloseFit™

Ultra Narrow Platform



Recommended insertion torque up to 50 Ncm

CloseFit™ UNP	Ø	L	D3	Catalog No.
	2.75	10.00	2.00	ISPUNP1027
		11.50	2.00	ISPUNP1127
		13.00	2.00	ISPUNP1327
		16.00	1.90	ISPUNP1627
		18.00	1.90	ISPUNP1827

Radiographic Template UNP CloseFit™ | ASD0615

## Drill Sequence

Recommended drilling speed up to 1200 rpm

Implant Diameter

ø2.75

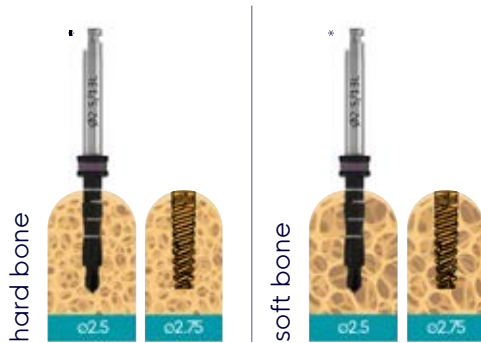

All measurements are in mm.

\*Products may be ordered separately as an addition to the kit

## Cover Screw & Healing Abutments

Recommended Torque 15(Ncm)

### UNP CloseFit™ Conical Cover Screw



UNP0073

### UNP CloseFit™ Slim Healing Abutment



UNP0046, GH2/L6.9

UNP0047, GH3/L7.9

UNP0048, GH4/L8.9

UNP0049, GH5/L9.9

UNP0050, GH6/L10.9

### UNP CloseFit™ Healing Abutment



UNP0004, GH2/L7.1

UNP0008, GH3/L8.1

UNP0009, GH4/L9.1

UNP0012, GH5/L10.1

UNP0013, GH6/L11.1

### UNP CloseFit™ Conical Healing Abutment



UNP0090, GH2/L6.9

UNP0091, GH3/L7.9

UNP0092, GH4/L8.9

UNP0093, GH5/L9.9

UNP0094, GH6/L10.9





# UNP™ Impression

Recommended Torque 15(Ncm)



Transfers		L	∅	D1	H	GH	RH	Catalog No.
	UNP Slim Open Tray Transfer	18.30	5.00	2.27	14.00	-	-	UNP5614
	UNP Open Tray Transfer	18.30	6.00	2.27	14.00	-	-	UNP5514
	UNP Slim Closed Tray Transfer	15.30	3.20	2.27	13.00	-	-	UNP5113
	UNP Closed Tray Transfer	15.30	4.00	2.27	13.00	-	-	UNP5213
	UNP ScanBody	9.3	-	2.27	7.00	-	-	UNP0088
		12.3	-	2.27	10.00	-	-	UNP0089

Analog/Digital Analog		L	∅	D1	H	GH	RH	Catalog No.
	UNP Implant Analog	12.60	2.75	2.27	-	-	-	UNP0007
	UNP Digital analog 15(Ncm)	10.00	3.55	2.27	-	-	-	UNP1000



# Cement Retained Abutments

Recommended Torque 25(Ncm)

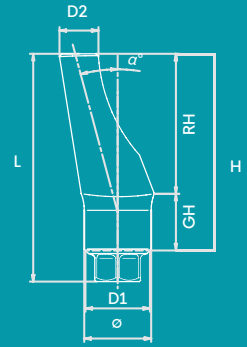

Abutments	L	Ø	D1	D2	H	GH	RH	Catalog No.
 UNP Straight Slim Abutment No End Line	11.00	3.50	2.27	2.89	8.70	1.00	7.30	UNP0010
 UNP Straight Abutment	9.85	4.20	2.27	3.00	7.55	1.00	6.50	UNP0019
	10.85	4.20	2.27	3.00	8.55	2.00	6.50	UNP0011
	11.85	4.20	2.27	3.00	9.55	3.00	6.50	UNP0064
 UNP Angled Abutment 15° No End Line	10.00	3.50	2.27	1.60	7.70	1.00	6.10	UNP0018
 UNP Angled Abutment 15°	9.85	4.20	2.27	2.40	7.55	1.00	6.50	UNP0063
	10.85	4.20	2.27	2.40	8.55	2.00	6.50	UNP0015
	11.85	4.20	2.27	2.40	9.55	3.00	6.50	UNP0026
 UNP Esthetic Abutment	10.30	4.00	2.27	2.80	10.00	1.00	7.00	UNP0080
	11.30	4.00	2.27	2.80	11.00	2.00	7.00	UNP0081
	12.30	4.00	2.27	2.80	12.00	3.00	7.00	UNP0082
 UNP One Piece Screw In Abutment	15.10	3.50	2.27	2.85	12.80	1.10	9.30	UNP3812
	16.00	3.50	2.27	2.85	13.70	2.00	9.30	UNP3813
	17.00	3.50	2.27	2.85	14.70	3.00	9.30	UNP3814
 UNP Engaging Temporary Abutment	12.30	3.70	2.27	3.20	10.00	2.00	8.00	UNP0043
 UNP Non Engaging Temporary Abutment	12.30	3.70	2.27	3.20	10.00	2.00	8.00	UNP0044
 UNP Engaging Plastic Cylinder Abutment	12.30	3.70	2.27	3.00	10.00	2.00	8.00	UNP0045







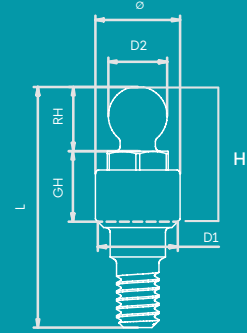

# Overdenture Restoration





Recommended Torque 25(Ncm)



Overdentures	L	Ø	D1	D2	H	GH	RH	Catalog No.
 UNP CloseFit™ Ball Attachment	7.75	2.40	2.27	2.50	3.00	0.50	2.45	UNP0020
	8.25	2.40	2.27	2.50	3.50	1.00	2.45	UNP0021
	9.25	2.40	2.27	2.50	4.50	2.00	2.45	UNP0022
	10.25	2.40	2.27	2.50	5.50	3.00	2.45	UNP0023
	11.25	2.40	2.27	2.50	6.50	4.00	2.45	UNP0024
	12.25	2.40	2.27	2.50	7.50	5.00	2.45	UNP0025

Caps	L	Ø	D1	D2	H	GH	RH	Catalog No.
 Plastic Ball Cap White (Nylon)	2.60	4.10	-	3.60	-	-	-	RS2660
 Plastic Ball Cap Pink Soft (Nylon)	2.60	4.10	-	3.60	-	-	-	RS2662
 Titanium Ball Cap	2.90	4.70	-	4.70	-	-	-	RS2670
 Stainless Steel Ball Cap	2.90	4.70	-	4.70	-	-	-	RS2675SS

Replica	L	Ø	D1	D2	H	GH	RH	Catalog No.
 Ball Attachment Abutment Replica	16.60	4.00	2.5	-	-	0.80	2.7	RS5740

		L	Ø	Catalog No.
	UNP Abutment Screw	7.90	2.00	UNP0001
	UNP Closed Tray Transfer Screw	20.00	2.80	UNP5127
	UNP Open Tray Transfer Screw	28.00	3.10	UNP5014
	NP Retrieval Screw for Abutments	13.4	2.00	NP0014





# Hand, Torque Drivers & Handpiece Drivers

Recommended Torque 25(Ncm)



Star Hand Driver -  
Short 23.40L

RP0064



Star Hand Driver -  
Long 28.40L

RP0004



Torque Driver for  
Ball Attachment  
24.4L

RS6090



Star Torque  
Driver - Short 20.4L

RP0065



Star Torque  
Driver-Long 25.40L

RP0005



Wrench Ratchet  
Surgical Instruments  
Handle 16.70L

RA0050



UNP 2mm Hex  
Handpiece Adapter  
Short 23.60L

UNP0068



UNP 2mm Hex  
Handpiece Adapter  
Medium 27.20L

UNP0071



UNP 2mm Hex  
Handpiece Adapter  
Long 36.00L

UNP0074



Star Handpiece  
Driver - Short 25.00L

RP0018



Star Handpiece  
Driver - Long 30.00L

RP0019



UNP/NP Abutment  
insertion tool 25.9L

UNP1001



# CloseFit™

# Regular & Wide Implants

Our strong CloseFit™ Conical Connection is designed for optimal seating while reducing and virtually eliminating micromovements.

Appropriate for immediate function/loading capability in all bone types.

CloseFit™ implants are designed to be used in all indications and in all regions of the lower and upper jaws.

The back-tapered coronal portion is designed to reduce pressure and enable healthy cortical bone around the implant collar .

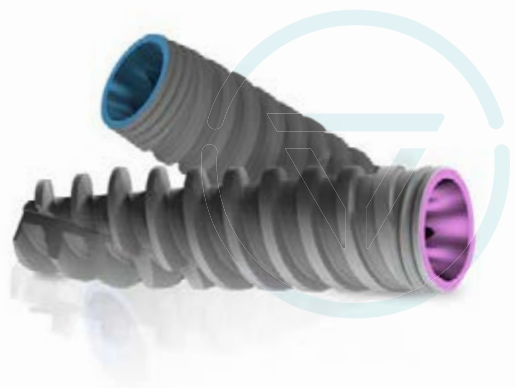

# CloseFit™ RP

3.5mmD  
Regular Platform

\* Built-In Platform  
Switching

\* Minimally  
invasive surgery

\* Osseofix™

L-8mm | L-10 mm | L-11.5 mm  
L-13 mm | L-16 mm | L-18 mm

# CloseFit™ WP

4.3/5.0mmD  
Wide Platform

\* Back  
tapered collar

\* Micro Threads:  
Engineered to enhance bone  
regeneration, prevent bone  
loss & increase bone implant  
contact

\* Bone - condensing property

\* Self - drilling

\*The features related to WP & RP Implants

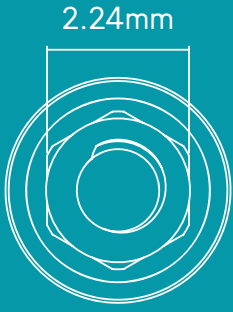

# RP CloseFit™

Regular Platform

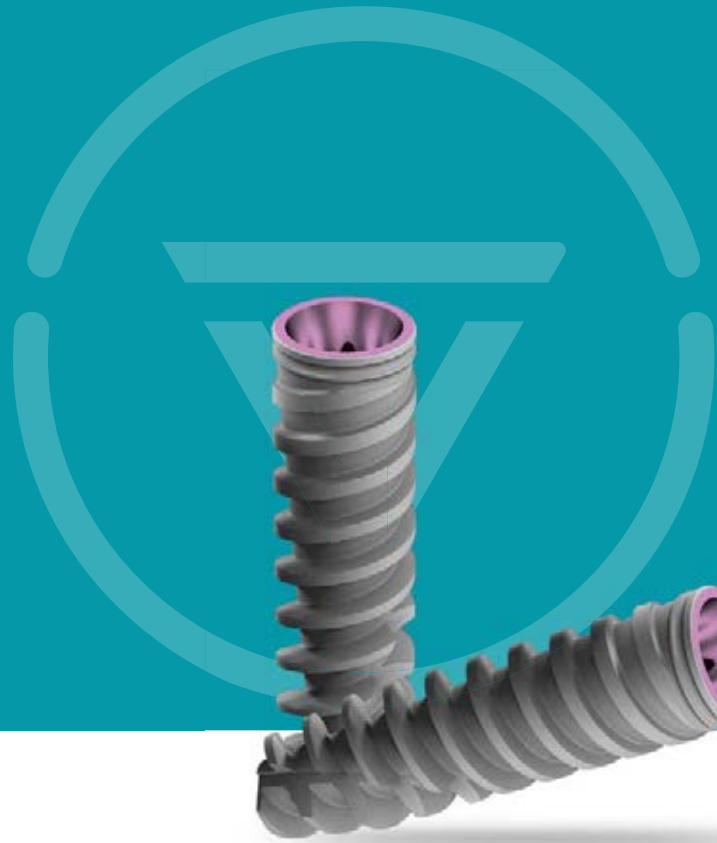

Recommended insertion torque up to 50 Ncm

CloseFit™ RP	Ø	L	D3	Catalog No.
	3.5	8	2.6	ISPX0835
		10	2.55	ISPX1035
		11.5	2.5	ISPX1135
		13	2.5	ISPX1335
		15	2.5	ISPX1535
		18	2.4	ISPX1835

Radiographic Template RP CloseFit™ | ASD0612

## Drill Sequence

Recommended drilling speed up to 1200 rpm

Implant Diameter

ø3.5

ø3.5

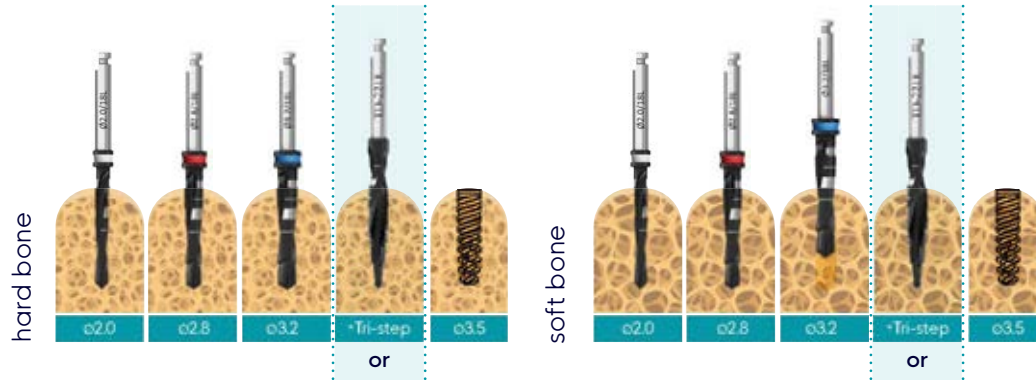

You may use Tri-Step drill instead of ø2, ø2.8 and ø3.2 drills in sequence.

## Cover Screw & Healing Abutments Recommended Torque 15(Ncm)

RP CloseFit™ Conical Cover Screw



RP0073

RP CloseFit™ Slim Healing Abutment

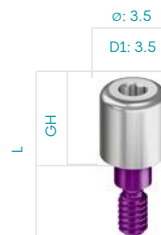

RP0046, GH2/L6.8

RP0047, GH3/L7.8

RP0048, GH4/L8.8

RP0049, GH5/L9.8

RP0050, GH6/L10.8

RP CloseFit™ Healing Abutment

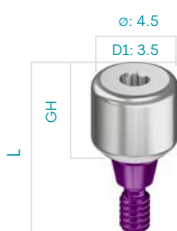

RP0022, GH2/L6.8

RP0023, GH3/L7.8

RP0024, GH4/L8.8

RP0025, GH5/L9.8

RP0026, GH6/L10.8

RP CloseFit™ Conical Healing Abutment



RP0090, GH2/L7.2

RP0091, GH3/L8.2

RP0092, GH4/L9.2

RP0093, GH5/L10.2

RP0094, GH6/L11.2





## RP™ Impression

Recommended Torque up to 15(Ncm)



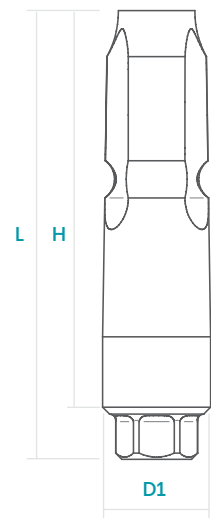

Our components for taking impressions for all restoration types can be successfully utilized for digital or conventional protocols either implant-level or abutment level procedures.

Our broad range of solutions and flexible designs enable easy and accurate restorative planning, whether you're dealing with a single tooth, multiple teeth, bridge or full mouth rehabilitation.



Transfers		L	∅	D1	H	GH	RH	Catalog No.
	RP Slim Closed Tray Transfer - Short	11.2	3.6	2.9	9.0	-	-	RP5109
	RP Slim Closed Tray Transfer - Long	15.2	3.6	2.9	13.0	-	-	RP5113
	RP Closed Tray Transfer - Short	11.20	4.25	2.90	9.0	-	-	RP5209
	RP Closed Tray Transfer - Long	15.20	4.25	2.90	13.0	-	-	RP5213
	RP Slim Open Tray Transfer - Short	14.20	5.00	2.90	10.0	-	-	RP5610
	RP Slim Open Tray Transfer - Long	18.20	5.00	2.90	14.0	-	-	RP5614
	RP Open Tray Transfer - Short	14.20	5.00	2.90	10.0	-	-	RP5510
	RP Open Tray Transfer - Long	18.20	5.00	2.90	14.0	-	-	RP5514
	RP Scan Body	9.2	-	2.9	7.0	-	-	RP0088
		12.2	-	2.9	10.0	-	-	RP0089

Analog / Digital Analog		L	∅	D1	H	GH	RH	Catalog No.
	RP implant analog	12.60	3.55	2.90	-	-	-	RP0007
	RP Digital Model Analog 15(Ncm)	10.00	3.55	2.90	-	-	-	RP1000



# Cement Retained Abutments

Recommended Torque 35(Ncm)

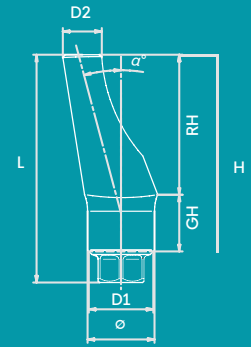

Abutments	L	Ø	D1	D2	H	GH	RH	Catalog No.
 RP Straight Slim Abutment No End Line	11.00	4.00	2.90	2.95	8.80	2.80	6.00	RP0020
 RP Esthetic Straight Abutment	9.70	4.40	2.90	3.00	7.50	1.00	6.50	RP0012
	10.70	4.40	2.90	3.00	8.50	2.00	6.50	RP0011
	11.70	4.40	2.90	3.00	9.50	3.00	6.50	RP0010
 RP Esthetic Angled Abutment 15°	9.70	4.40	2.90	2.34	7.50	1.00	6.50	RP0013
	10.70	4.40	2.90	2.34	8.50	2.00	6.50	RP0014
	11.70	4.40	2.90	2.34	9.70	3.00	6.50	RP0015
 RP Engaging Temporary Abutment	12.65	3.70	2.90	3.40	10.45	1.00	9.45	RP0043
 RP Non Engaging Temporary Abutment	12.65	3.70	2.90	3.40	10.45	1.00	9.45	RP0044
 RP Engaging Plastic Cylinder Abutment (Casting)	12.70	3.70	2.90	3.00	10.50	1.00	9.50	RP0045
 RP Engaging Titanium/Plastic Abutment (Casting)	13.70	4.70	2.90	4.70	11.50	1.50	10.00	RP3095
 RP Non-Engaging Titanium/Plastic Abutment (Casting)	13.70	4.70	2.90	4.70	11.50	1.36	10.00	RP3097



# TMA™ - Multi Unit

Recommended Torque 35(Ncm)

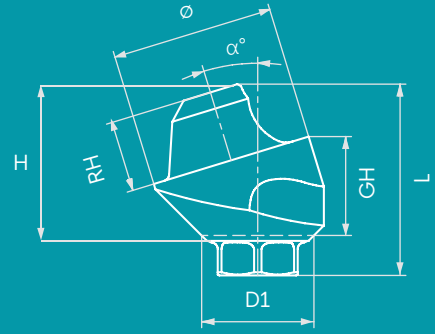





Our TMA™ (Trans Mucosal Abutment) system is indicated for multiple-unit, screw-retained restorations and may be used in combination with an implant level framework design.

The TMA™ system is used to elevate the restorative seating platform when restoration at implant level is not indicated or practical due to the depth or angle of the implant.

The TMA™ System is designed to allow better prosthetics access when using implants with divergent angles accommodate full and partial edentulous arches, especially when using angled implants and all-on-x technique for full arch restoration.

The TMA™ abutment system is available in straight or angled (17°, 30°), engaging the Conical Connection for indexing, with a selection of collar heights. Abutments are delivered with handles for easy insertion and to assist with seating.

TMA		L	Ø	D1	H	GH	RH	Catalog No.
	RP Straight Trans Mucosal Abutment	4.20	4.90	2.90	2.00	1.00	2.10	RP0032
		5.20	4.90	2.90	3.00	2.00	2.10	RP0033
		6.20	4.90	2.90	4.00	3.00	2.10	RP0034
		7.20	4.90	2.90	5.00	4.00	2.10	RP3729
		8.20	4.90	2.90	6.00	5.00	2.10	RP3730
	RP Angled Trans Mucosal Abutment 17° 2.5mm	6.62	4.90	2.90	-	2.58	2.15	RP3734
	RP Angled Trans Mucosal Abutment 17° 3.5mm	7.65	4.90	2.90	-	3.68	2.15	RP3737
	RP Angled Trans Mucosal Abutment 30° 3mm	6.97	4.90	2.90	-	3.65	2.15	RP3735
	RP Angled Trans Mucosal Abutment 30° 4mm°	8.00	4.90	2.90	-	4.00	2.15	RP3738

TMA components		L	∅	D1	D2	H	GH	RH	Catalog No.
	TMA Healing Cap	5.5	4.9	-	3.5	-	-	-	RS5005
		7	4.9	-	3.5	-	-	-	RS5003
	TMA Impression Coping Open Tray	11.0	4.9	-	3.1	-	-	-	RS5006
	TMA Closed Tray Transfer	8.0	4.9	-	4.0	-	-	-	RS5011
	TMA Scan Body	6	4.9	4.9	3.8	-	-	-	TM0006
		9	4.9	4.9	3.8	-	-	-	TM0009
	TMA Titanium Temporary Cylinder	12.0	4.9	-	3.5	-	1.5	10.5	RS4900
	TMA Cementing Cone	4.9	4.9	-	2.9	-	1.5	3.4	TM0010
	TMA Plastic Casting Sleeve w/ Prosthetic Screw	12.0	4.9	-	3.3	-	1.5	10.5	RS5001
	TMA Abutment Replica	16.8	4.9	-	1.7	-	-	-	RS5004
	TMA Digital Model Replica Recommended torque 15(Ncm)	12.0	4.9	-	3.8	-	-	-	RS1001





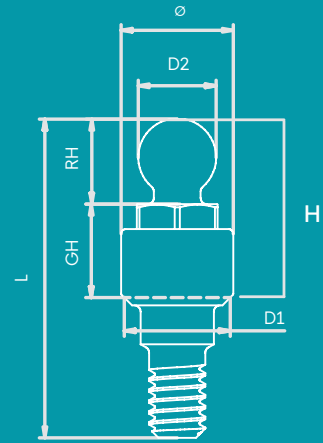

# Overdenture Restoration

Recommended Torque 35(Ncm)



Ball Attachment		L	Ø	D1	D2	H	GH	RH	Catalog No.
	RP Ball Attachment	8.86	3.10	2.90	2.50	4.00	0.50	3.52	RP0051
		9.32	3.10	2.90	2.50	4.50	1.00	3.52	RP0052
		10.32	3.10	2.90	2.50	5.50	2.00	3.52	RP0053
		11.32	3.10	2.90	2.50	6.50	3.00	3.52	RP0054
		12.32	3.10	2.90	2.50	7.50	4.00	3.52	RP0055
		13.32	3.10	2.90	2.50	8.50	5.00	3.52	RP0056

Ball Attachment caps		L	Ø	D1	D2	H	GH	RH	Catalog No.
	Plastic Ball Cap White (Nylon)	2.60	4.10	-	3.60	-	-	-	RS2660
	Plastic Ball Cap Pink Soft (Nylon)	2.60	4.10	-	3.60	-	-	-	RS2662
	Titanium Ball Cap	2.90	4.70	-	4.70	-	-	-	RS2670
	Stainless Steel Ball Cap	2.90	4.70	-	4.70	-	-	-	RS2675SS

Ball Attachment		L	Ø	D1	D2	H	GH	RH	Catalog No.
	Ball Attachment Abutment Replica	16.60	4.00	-	2.5	-	0.80	2.7	RS5740







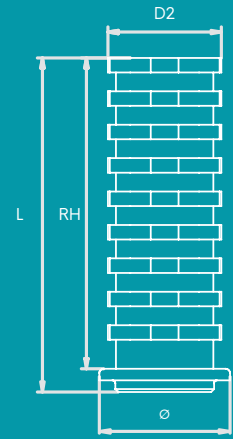







# Screw - Retained

Recommended Torque 35(Ncm)



Flat Connection	L	Ø	D1	D2	H	GH	RH	Catalog No.
	6.80	4.50	2.90	-	2.04	2.04	-	RP0030
RP Flat Connection Abutment	8.80	4.50	2.90	-	4.04	4.04	-	RP0031
	11.5	4.5	-	3.9	11.1	0.4	10.7	FC5515
	12.6	4.5	-	3.4	-	-	-	FC5737
	13.6	4.6	-	3.0	13.6	0.1	13.5	FC6011
	5.0	2.5	-	-	-	-	-	FC6015
	3.8	4.5	-	3.1	3.4	0.6	2.8	FC6013
	17.0	2.5	-	-	-	-	-	FC6017
	3.8	4.5	-	3.2	3.4	0.6	2.8	FC6018
	11.0	4.5	-	4.2	-	-	10.2	FC5512

RP CloseFit™ Screws		L	Ø	Catalog No.
	RP Abutment Screw	7.20	2.20	RP0001
	TMA Prosthetic Screw 15(Ncm)	4.1	2.1	RS3404
	RP Retaining Screw for TMA 1mm	8.00	3.10	RP0039
	RP Retaining Screw for TMA 2mm	9.00	3.10	RP0040
	RP Retaining Screw for TMA 3mm	10.00	3.10	RP0041
	RP Retaining Screw for TMA 4mm	11.00	3.10	RP3409
	RP Retaining Screw for TMA 5mm	12.00	3.10	RP3412
	RP Retaining Screw for Angled TMA	7.00	2.35	RP3403
	RP Open Tray Transfer Screw - Short	24.00	3.10	RP5010
	RP Open Tray Transfer Screw - Long	28.00	3.10	RP5014
	RP Closed Tray Transfer Screw - Short	16.00	2.80	RP5126
	RP Closed Tray Transfer Screw - Long	20.00	2.80	RP5127
	RP Retrieval Screw for Abutments	12.60	2.25	RP3401





# Hand & Torque Drivers



Star Hand Driver Short 23.4L RP0064

\*For Angeld TMA/TMA prosthetic screw



Star Hand Driver Long 23.4L RP0004

\*For Angeld TMA/TMA prosthetic screw



TMA/FC Female Hand Hex Driver - Short 22.4L RS6193

\*For straight TMA/Flat connection



TMA/FC Female Hand Hex Driver Long 28.4L RS6191

\*For straight TMA/Flat connection



RP 2.2mm Hex Torque Driver Short 20.0L RP0067



RP 2.2mm Hex Torque Driver-Long 25.0L RP0066



Star Torque Driver Short 20.40L RP0065

\*For Angeld TMA/TMA prosthetic screw



Star Torque Driver - Long 25.4L RP0005

\*For Angeld TMA/TMA prosthetic screw



TMA/FC Hex Torque Driver - Short 20.0L RS6197

\*For straight TMA/Flat connection



TMA/FC Hex Torque Driver Long 25.0L RS6196

\*For straight TMA/Flat connection



Torque Driver for Ball Attachment 16.7L RS6090



Wrench Ratchet Surgical Instruments Handle 16.70L RA0050



# Handpiece Drivers



RP 2.25mm Hex Handpiece Adapter Short 23.7L

RP0068



RP 2.25mm Hex Handpiece Adapter Medium 27.6L

RP0071



RP 2.25mm Hex Handpiece Adapter Long 36.0L

RP0074



Star Handpiece Driver - Short 25.0L

RP0018



Star Handpiece Driver - Long 30.0L

RP0019



RP Handpiece Hex Adapter - Short 20.0L

RP0062

\*For Angeld TMA/TMA prosthetic screw

\*For Angeld TMA/TMA prosthetic screw



RP Handpiece Hex Adapter - Long 25.0L

RP0072



TMA/FC Hex Handpiece Adapter - Short 20.0L

RS6194

\*For straight TMA/Flat connection



TMA/FC Hex Handpiece Adapter - Long 25.0L

RS6195A

\*For straight TMA/Flat connection



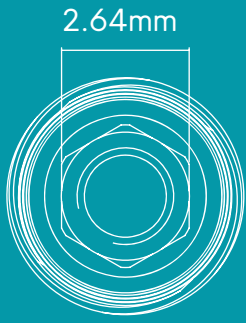

# WP CloseFit™

Wide Platform



Recommended insertion torque up to 50 Ncm

CloseFit™ WP	∅	L	D3	Catalog No.
	4.3	8.0	3.3	ISPX0843
		10.0	3.2	ISPX1043
		11.5	3.1	ISPX1143
		13.0	3.0	ISPX1343
		15.0	2.8	ISPX1543
		18.0	2.6	ISPX1843
	5	8.0	3.9	ISPX0849
		10.0	3.9	ISPX1049
		11.5	3.8	ISPX1149
		13.0	3.7	ISPX1349
		15.0	3.5	ISPX1549
		18.0	3.3	ISPX1849

Radiographic Template RP CloseFit™ | ASD0612

## Drill Sequence Recommended drilling speed up to 1200 rpm

Implant Diameter

ø4.3

ø5.0

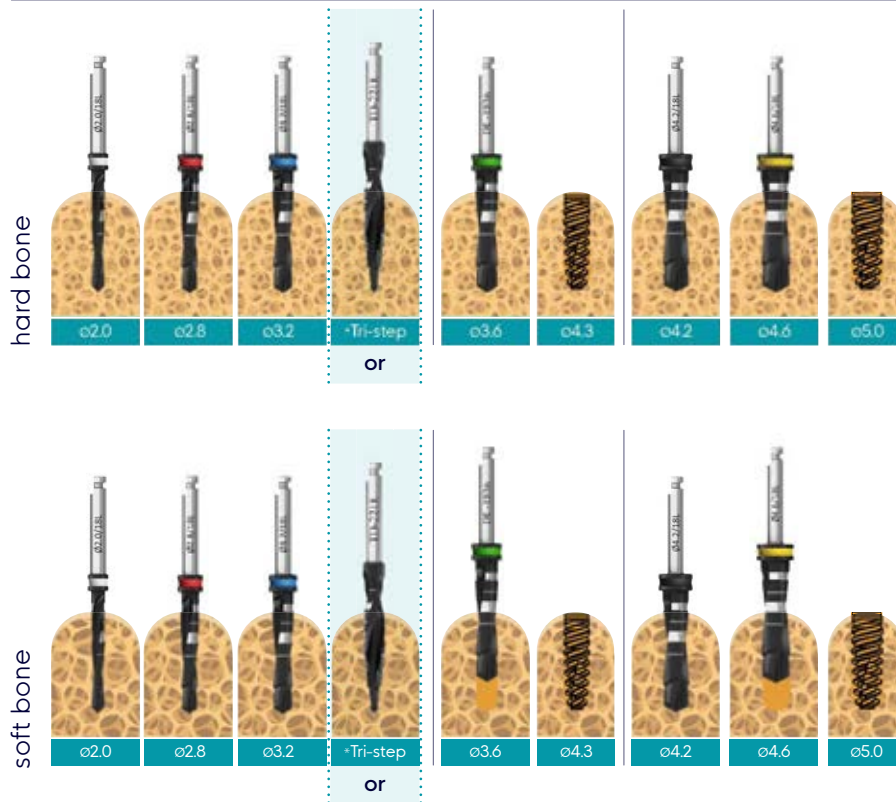

You may use Tri-Step drill instead of ø2, ø2.8 and ø3.2 drills in sequence.

## Cover Screw & Healing Abutments Recommended Torque 15(Ncm)

### WP CloseFit™ Conical Cover Screw



WP0073

### WP CloseFit™ Slim Healing Abutment



WP0046, GH2/L7.3  
 WP0047, GH3/L8.3  
 WP0048, GH4/L9.3  
 WP0049, GH5/L10.3  
 WP0050, GH6/L11.3

### WP CloseFit™ Healing Abutment



WP0022, GH2/L7.3  
 WP0023, GH3/L8.3  
 WP0024, GH4/L9.3  
 WP0025, GH5/L10.3  
 WP0026, GH6/L11.3

### WP CloseFit™ Conical Healing Abutment



WP0090, GH2/L7.9  
 WP0091, GH3/L8.9  
 WP0092, GH4/L9.9  
 WP0093, GH5/L10.9  
 WP0094, GH6/L11.9



# WP™ Impression

Recommended Torque 15(Ncm)

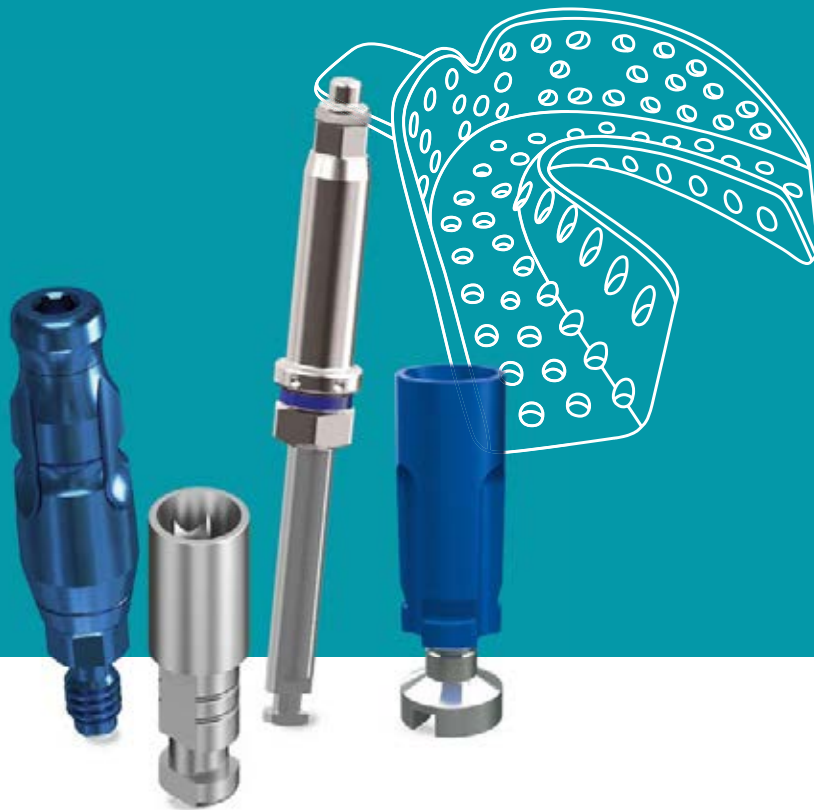

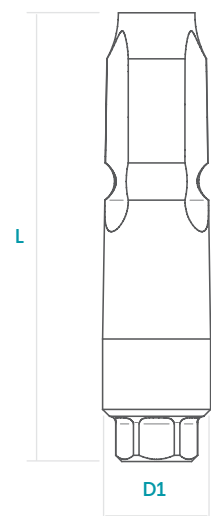

Our components for taking impressions for all restoration types can be successfully utilized for digital or conventional protocols either implant-level or abutment level procedures.

Our broad range of solutions and flexible designs enable easy and accurate restorative planning, whether you're dealing with a single tooth, multiple teeth, bridge or full mouth rehabilitation.



Transfers		L	∅	D1	H	GH	RH	Catalog No.
	WP Slim Closed Tray Transfer - Short	11.30	4.00	3.35	9.00	-	-	WP5109
	WP Slim Closed Tray Transfer - Long	15.30	4.00	3.35	13.00	-	-	WP5113
	WP Closed Tray Transfer - Short	11.30	5.20	3.35	9.00	-	-	WP5209
	WP Closed Tray Transfer - Long	15.30	5.20	3.35	13.00	-	-	WP5213
	WP Wide Closed Tray Transfer - Short	11.30	6.00	3.35	9.00	-	-	WP5309
	WP Wide Closed Tray Transfer - Long	15.30	6.00	3.35	13.00	-	-	WP5313
	WP Slim Open Tray Transfer - Short	14.30	6.00	3.35	10.00	-	-	WP5610
	WP Slim Open Tray Transfer - Long	18.30	6.00	3.35	14.00	-	-	WP5614
	WP Open Tray Transfer - Short	14.30	5.20	3.35	10.00	-	-	WP5510
	WP Open Tray Transfer - Long	18.30	5.20	3.35	14.00	-	-	WP5514
	WP Wide Open Tray Transfer - Short	14.30	6.00	3.35	10.00	-	-	WP5410
	WP Wide Open Tray Transfer - Long	18.30	6.00	3.35	14.00	-	-	WP5414
	WP Scan Body	9.3	-	3.35	7.0	-	-	WP0088
		12.3	-	3.35	10.0	-	-	WP0089

Analog / Digital Analog		L	∅	D1	H	GH	RH	Catalog No.
	WP Implant Analog	13.10	4.00	3.35	-	-	-	WP0007
	WP Digital Model Analog 15 (Ncm)	10.00	4.00	3.35	-	-	-	WP1000



# Cement Retained Abutments

Recommended Torque 35(Ncm)

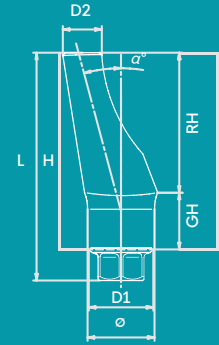

Abutments	L	∅	D1	D2	H	GH	RH	Catalog No.
 WP Straight Slim Abutment No End Line	11.00	4.20	3.35	3.36	8.70	2.70	6.00	WP0020
 WP Straight Abutment	9.80	5.05	3.35	3.57	7.50	1.00	6.50	WP0012
	10.80	5.05	3.35	3.57	8.50	2.00	6.50	WP0011
	11.80	5.05	3.35	3.57	9.50	3.00	6.50	WP0010
 WP Angled Abutment 15°	9.80	5.05	3.35	2.61	7.50	1.00	6.50	WP0013
	10.80	5.05	3.35	2.61	8.50	2.00	6.50	WP0014
	11.80	5.05	3.35	2.61	9.50	3.00	6.50	WP0015
 WP Engaging Temporary Abutment	12.65	4.20	3.35	3.90	10.35	0.90	9.45	WP0043
 WP Non-Engaging Temporary Abutment	12.65	4.20	3.35	3.90	10.35	0.90	9.45	WP0044
 WP Plastic Cylinder Abutment (Casting)	12.65	4.20	3.35	3.40	10.35	0.90	9.45	WP0045
 WP Engaging Titanium/Plastic Abutment (Casting)	13.80	5.20	3.35	5.20	11.50	1.50	10.00	WP3095
	13.80	5.20	3.35	5.20	11.50	1.50	10.00	WP3097



# TMA™ - Multi Unit

Recommended Torque 35(Ncm)

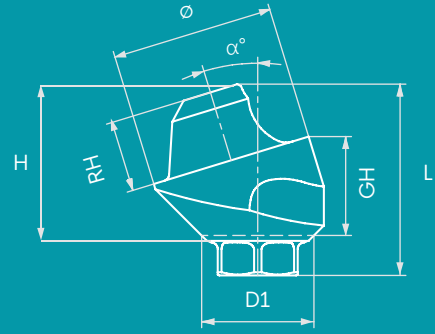





Our TMA™ (Trans Mucosal Abutment) system is indicated for multiple-unit, screw-retained restorations and may be used in combination with an implant level framework design.

The TMA™ system is used to elevate the restorative seating platform when restoration at implant level is not indicated or practical due to the depth or angle of the implant.

The TMA™ System is designed to allow better prosthetics access when using implants with divergent angles accommodate full and partial edentulous arches, especially when using angled implants and all-on-x technique for full arch restoration.

The TMA™ abutment system is available in straight or angled (17°,30°,45°), engaging the Conical Connection for indexing, with a selection of collar heights. Abutments are delivered with handles for easy insertion and to assist with seating.

TMA		L	Ø	D1	H	GH	RH	Catalog No.
	WP Straight Trans Mucosal Abutment	4.30	4.90	3.35	2.0	1.0	2.10	WP3731
		5.30	4.90	3.35	3.0	2.0	2.10	WP3732
		6.30	4.90	3.35	4.0	3.0	2.10	WP3733
		7.30	4.90	3.35	5.0	4.0	2.10	WP3729
		8.30	4.90	3.35	6.0	5.0	2.10	WP3730
	WP Angled Trans Mucosal Abutment 17° 2.5mm	6.7	4.90	3.35	-	2.54	2.15	WP3734
	WP Angled Trans Mucosal Abutment 17° 3.5mm	7.44	4.90	3.35	-	3.56	2.15	WP3737
	Angled Trans Mucosal Abutment 30° 3mm	6.8	4.90	3.35	-	3.45	2.15	WP3735
	WP Angled Trans Mucosal Abutment 30° 4mm	8.04	4.90	3.35	-	4.11	2.15	WP3738



TMA components		L	∅	D1	D2	H	GH	RH	Catalog No.
	TMA Healing Cap	5.5	4.9	-	3.5	-	-	-	RS5005
		7	4.9	-	3.5	-	-	-	RS5003
	TMA Impression Coping Open Tray	11.0	4.9	-	3.1	-	-	-	RS5006
	TMA Closed Tray Transfer	8.0	4.9	-	4.0	-	-	-	RS5011
	TMA Scan Body	6	4.9	6.5	3.8	4.9	-	-	TM0006
		9	4.9	6.5	3.8	4.9	-	-	TM0009
	TMA Titanium Temporary	12.0	4.9	-	3.5	-	1.5	10.5	RS4900
	TMA Cementing Cone	4.9	4.9	-	2.9	-	1.5	3.4	TM0010
	TMA Plastic Casting Sleeve w/ Prosthetic Screw	12.0	4.9	-	3.3	-	1.5	10.5	RS5001
	TMA Abutment Replica	16.8	4.9	-	1.7	-	-	-	RS5004
	TMA Digital Model Replica Recommended torque 15(Ncm)	12	4.9	-	3.8	-	-	-	RS1001







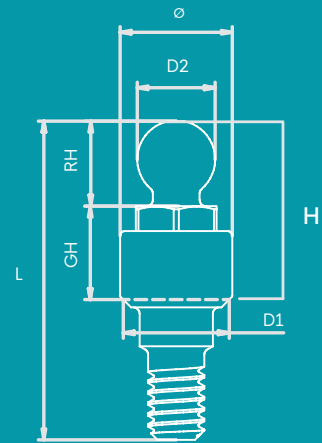

# Overdenture Restoration

Recommended Torque 35(Ncm)



Ball Attachment		L	Ø	D1	D2	H	GH	RH	Catalog No.
	WP Ball Attachment	9.32	3.50	3.35	2.50	4.00	0.50	2.72	WP0051
		9.82	3.50	3.35	2.50	4.50	1.00	2.72	WP0052
		10.82	3.50	3.35	2.50	5.50	2.00	2.72	WP0053
		11.82	3.50	3.35	2.50	6.50	3.00	2.72	WP0054
		12.82	3.50	3.35	2.50	7.50	4.00	2.72	WP0055
		13.82	3.50	3.35	2.50	8.50	5.00	2.72	WP0056

Ball Attachment caps		L	Ø	D1	D2	H	GH	RH	Catalog No.
	Plastic Ball Cap White (Nylon)	2.60	4.10	-	3.60	-	-	-	RS2660
	Plastic Ball Cap Pink Soft (Nylon)	2.60	4.10	-	3.60	-	-	-	RS2662
	Titanium Ball Cap	2.90	4.70	-	4.70	-	-	-	RS2670
	Stainless Steel Ball Cap	2.90	4.70	-	4.70	-	-	-	RS2675SS

Ball Attachment		L	Ø	D1	D2	H	GH	RH	Catalog No.
	Ball Attachment Abutment Replica	16.60	4.00	-	2.50	-	0.80	2.70	RS5740







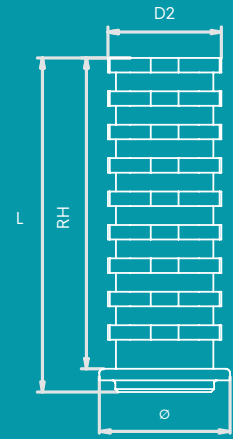







# Screw - Retained

Recommended Torque 35(Ncm)



Flat Connection	L	Ø	D1	D2	H	GH	RH	Catalog No.
	7.40	4.50	3.35	-	2.0	2.0	-	WP0030
WP Flat Connection Abutment	9.40	4.50	3.35	-	4.0	4.0	-	WP0031
	11.50	4.50	-	3.90	11.10	0.40	10.70	FC5515
	13.60	4.60	-	3.00	13.60	0.10	13.50	FC6011
	5.00	2.50	-	-	-	-	-	FC6015
	3.80	4.50	-	3.10	3.40	0.60	2.80	FC6013
	17.00	-	-	2.50	-	-	-	FC6017
	3.80	4.50	-	3.20	3.40	0.60	2.80	FC6018
	11.00	4.50	-	4.20	-	-	10.2	FC5512
	12.60	4.50	-	3.4	-	-	-	FC5737

Screws		L	Ø	Catalog No.
	WP Abutment Screw	7.5	2.55	WP0001
	TMA Prosthetic Screw <sup>15(Ncm)</sup>	4.1	2.1	RS3404
	WP Retaining Screw for TMA	6.50	3.10	WP3406
	WP Retaining Screw for TMA	7.50	3.10	WP3407
	WP Retaining Screw for TMA	8.50	3.10	WP3408
	WP Retaining Screw for TMA	9.50	3.10	WP3409
	WP Retaining Screw for TMA	10.50	3.10	WP3412
	WP Retaining Screw for Angled TMA	7.10	2.35	WP3403
	WP Open Tray Transfer Screw - Short	24.00	3.10	WP5010
	WP Open Tray Transfer Screw - LONG	28.00	3.10	WP5014
	WP Closed Tray Transfer Screw - Short	16.50	3.10	WP5126
	WP Closed Tray Transfer Screw - Long	20.00	3.10	WP5127
	WP Retrieval Screw for Abutments	12.30	2.55	WP3401



# Hand & Torque Drivers



Star Hand Driver  
Short 23.4L  
RP0064

\*For Angeld TMA/TMA prosthetic screw



Star Hand Driver  
Long 23.4L  
RP0004

\*For Angeld TMA/TMA prosthetic screw



TMA/FC Female  
Hand Hex Driver - Short  
22.4L  
RS6193

\*For straight TMA/Flat connection



TMA/FC Female  
Hand Hex Driver  
Long 28.4L  
RS6191

\*For straight TMA/Flat connection



WP 2.6mm  
Torque Driver  
Short 20.0L  
WP0067



WP 2.6mm Torque  
Driver-Long 25.0L  
WP0066



Star Torque  
Driver  
Short 20.40L  
RP0065

\*For Angeld TMA/TMA prosthetic screw



Star Torque  
Driver - Long  
25.4L  
RP0005

\*For Angeld TMA/TMA prosthetic screw



TMA/FC Hex Torque  
Driver - Short 20.0L  
RS6197

\*For straight TMA/Flat connection



TMA/FC Hex  
Torque Driver  
Long 25.0L  
RS6196

\*For straight TMA/Flat connection



Torque Driver for  
Ball Attachment  
16.7L  
RS6090



Wrench Ratchet  
Surgical Instruments  
Handle 16.70L  
RA0050



# Handpiece Drivers



WP 2.65mm  
Handpiece Adapter  
Short 23.85L

WP0068



WP 2.65mm  
Handpiece Adapter  
Medium 27.85L

WP0071



WP 2.65mm  
Handpiece Adapter  
Long 35.95L

WP0074



Star Handpiece  
Driver - Short 25.0L

RP0018



Star Handpiece  
Driver - Long 30.0L

RP0019



WP Handpiece Hex  
Adapter - Short 20.0L

WP0062

\*For Angeld TMA/TMA prosthetic screw

\*For Angeld TMA/TMA prosthetic screw



WP Handpiece Hex  
Adapter - Long 25.0L

WP0072



TMA/FC Hex  
Handpiece  
Adapter - Short 20.0L

RS6194



TMA/FC Hex Handpiece  
Adapter - Long 25.0L

RS6195A

\*For straight TMA/Flat connection

\*For straight TMA/Flat connection







# Tri-Step & Twist Step Surgical Drills



Our DLC (Diamond Like Carbon) Tri-Step/Twist Step Surgical Drills are uniquely designed and coated to improve the surgical drilling process.

Tri-Step & Twist-Step DLC drills simplify the cutting process, save time and minimize risks.

Our improved DLC drill coating provides state-of-the-art hardness and slickness that increases lifespan of the drill, maintains sharpness for extended drilling and generates less heat, thereby reducing chances of heating the bone or complications arising from conventional drilling protocols.

The drills come in the following diameters: 2.0, 2.5, 2.8, 3.2, 3.6, 4.2, 4.6, 5.2, 5.6

Specially designed for Adin's implants and suitable for their simple and convenient drilling protocol. They are clearly and conveniently marked and can be used with or without drill stops.



## Tri-Step drills

Adin's Tri-Step drills condense drilling protocols and avoid the need for using multiple drills throughout complex procedures.











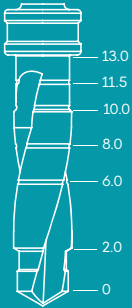







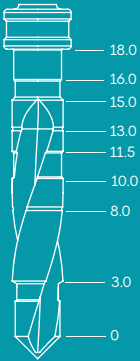

Because friction at the cutting site is reduced, complications common with high speed drilling are decreased and faster & better recovery can occur.

L	Ø		Size	Catalog No.
	1.8-3.2		short	TD1511
	1.8-3.2		long	TD2218









# Twist Step drills

L	Ø		Color	Catalog No.
<b>short</b>  <b>6-13mm</b>	2.0		white	DL1320
	1.8-2.5		purple	DL1325
	2.3-2.8		red	DL1328
	2.8-3.2		blue	DL1332
	3.2-3.6		green	DL1336
	3.8-4.2		black	DL1342
	4.2-4.6		yellow	DL1346
	4.8-5.2		brown	DL1352
	5.2-5.6		grey	DL1356
	<b>long</b>  <b>8-18mm</b>	2.0		white
1.8-2.5			purple	DL1825
2.3-2.8			red	DL1828
2.8-3.2			blue	DL1832
3.2-3.6			green	DL1836
3.8-4.2			black	DL1842
4.2-4.6			yellow	DL1846
4.8-5.2			brown	DL1852
5.2-5.6			grey	DL1856



# Tools



		Catalog No.
	Surgical Torque Ratchet 35-100 Ncm	RS6111
	Prosthetic Torque Ratchet 15-35 Ncm	RS6112
	Wrench Ratchet	RS6100
	Surgical Driver	RS7001



Depth Probe

RS6180

Tools



Parallel Pin 11mm

RS6150



Parallel Pin 16mm

RS6155



Drill Extension

RS9027

Osteotomes



Osteotome Handle

HA0074

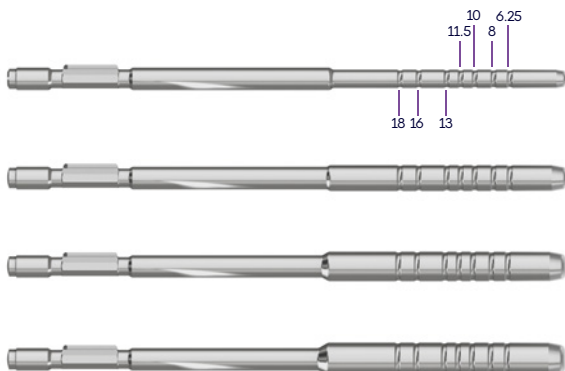

Osteotome Insert 2.0mmD

HA0061

Osteotome Insert 2.8mmD

HA0064

Osteotome Insert 3.25mmD

HA0067

Osteotome Insert 3.65mmD

HA0070







## Surgical Kits Conical connection

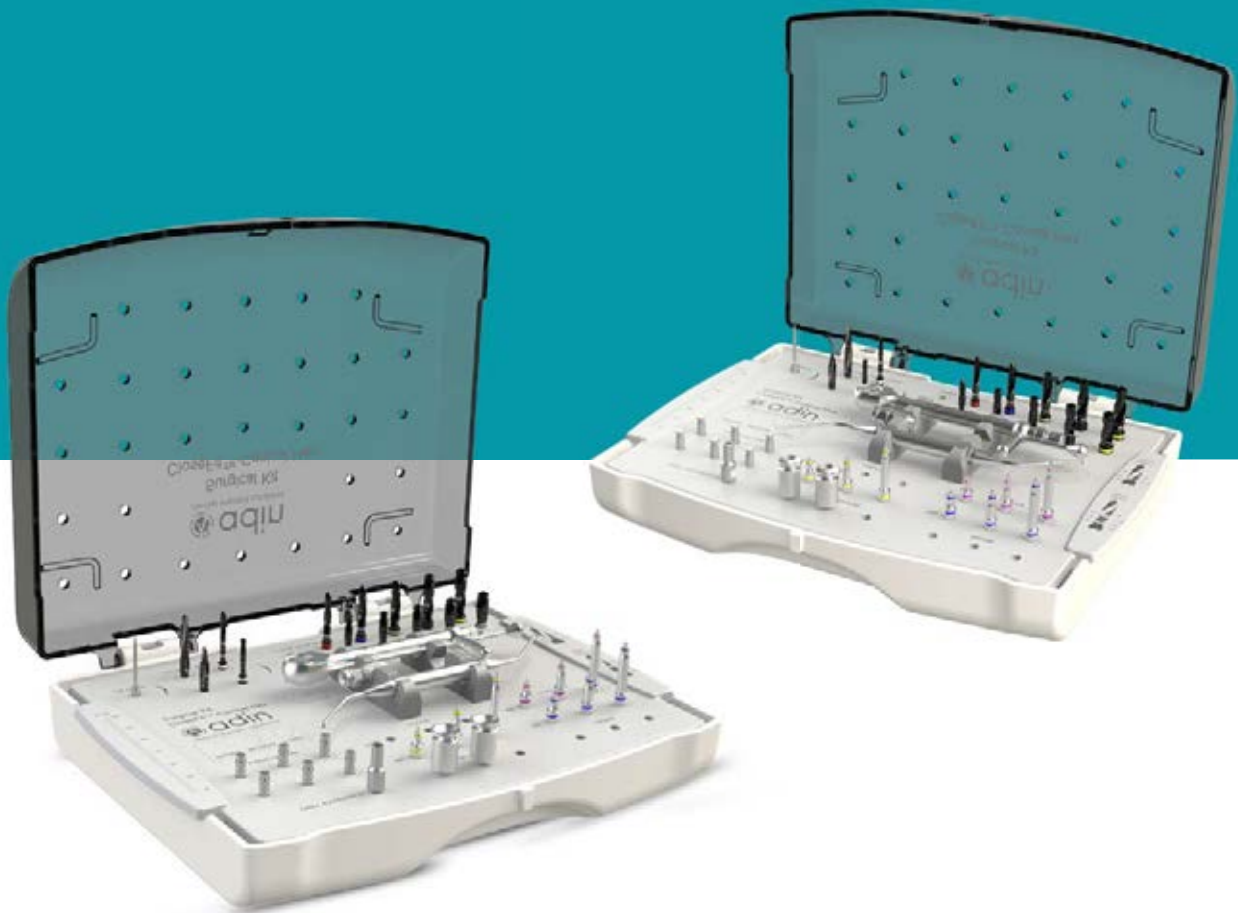

Successful surgical procedures start with having the right instruments and tools to ensure your desired treatment outcomes are met.

That's why our range has everything you need, including drills, keys, ratchets and insertion tools. Not only do they make procedures safer and simpler, they result in an enhanced patient experience as well.

Our Surgical Kits streamline and simplify your implant procedures.

Surgical Kits contain			Premium CF6300	Advanced CF6302	Starter CF6303
	<b>Drills:</b> RS8032	Tip Drill	V		
	TD2218	Tri-Step Drill-Long	V		
	DL1820	Pilot Drill 2mmD x 8-18mmL	V	V	V
	DL1825	Twist Step Drill 1.8/2.5mmD x 8-18mmL	*		
	DL1828	Twist Step Drill 2.3/2.8mmD x 8-18mmL	V	V	V
	DL1832	Twist Step Drill 2.8/3.2mmD x 8-18mmL	V	V	V
	DL1836	Twist Step Drill 3.2/3.6mmD x 8-18mmL	V	V	V
	DL1842	Twist Step Drill 3.8/4.2mmD x 8-18mmL	V	V	
	DL1846	Twist Step Drill 4.2/4.6mmD x 8-18mmL	V	V	
	TD1511	Tri-Step Drill - Short	V		
	DL1320	Pilot Drill 2mmD x 6-13mmL	V		
	DL1325	Twist Step Drill 1.8/2.5mmD x 6-13mmL	*		
	DL1328	Twist Step Drill 2.3/2.8mmDx6-13mmL	V		
	DL1332	Twist Step Drill 2.8/3.2mmDx6-13mmL	V		
	DL1336	Twist Step Drill 3.2/3.6mmDx6-13mmL	V		
	DL1342	Twist Step Drill 3.8/4.2mmDx6-13mmL	V		
	DL1346	Twist Step Drill 4.2/4.6mmDx6-13mmL	V		
	<b>Surgical tools:</b> RS6111	Surgical Torque Ratchet 35-100 Ncm	V	V	V
	RA0050	Wrench Ratchet Surgical Instruments Handle	V	V	V
	RS6180	Depth Probe	V	V	
	<b>Parallel pins:</b> RS6150	Parallel Pin Short (qty. 4)	V	V	
	RS6155	Parallel Pin Long (qty. 2)	V	V	
	<b>Inserion tools:</b> NP0068	NP 2mm Hex Handpiece Adapter - Short	V	V	V
	NP0071	NP 2mm Hex Handpiece Adapter - Medium	V	V	V
	NP0074	NP 2mm Hex Handpiece Adapter - Long	V	V	V
	RP0068	RP 2.25mm Hex Handpiece Adapter - Short	V	V	V
	RP0071	RP 2.25mm Hex Handpiece Adapter - Medium	V	V	V
	RP0074	RP 2.25mm Hex Handpiece Adapter - Long	V	V	V
	WP0068	WP 2.65mm Hex Handpiece Adapter - Short	V	V	V
	WP0071	WP 2.65mm Hex Handpiece Adapter - Medium	V	V	V
	WP0074	WP 2.65mm Hex Handpiece Adapter - Long	V	V	V
	<b>Drivers:</b> RP0064	Star Hand Driver - Short	V	V	V
	RP0004	Star Hand Driver - Long	V	V	V
	<b>Drill extension:</b> RS9027	Drill Extension	V	V	

\*Products may be ordered separately as an addition to the kit

# Premium Kit CF6300



Drills	Catalog No.
Tip Drill	RS8032
Tri-Step Drill-Long	TD2218
Pilot Drill 2mmD x 8-18mmL	DL1820
Twist Step Drill 1.8/2.5mmD x 8-18mmL	DL1825
Twist Step Drill 2.3/2.8mmD x 8-18mmL	DL1828
Twist Step Drill 2.8/3.2mmD x 8-18mmL	DL1832
Twist Step Drill 3.2/3.6mmD x 8-18mmL	DL1836
Twist Step Drill 3.8/4.2mmD x 8-18mmL	DL1842
Twist Step Drill 4.2/4.6mmD x 8-18mmL	DL1846
Tri-Step Drill - Short	TD1511
Pilot Drill 2mmD x 6-13mmL	DL1320
*Twist Step Drill 1.8/2.5mmDx6-13mmL	DL1325
Twist Step Drill 2.3/2.8mmDx6-13mmL	DL1328
Twist Step Drill 2.8/3.2mmDx6-13mmL	DL1332
Twist Step Drill 3.2/3.6mmDx6-13mmL	DL1336
Twist Step Drill 3.8/4.2mmDx6-13mmL	DL1342
Twist Step Drill 4.2/4.6mmDx6-13mmL	DL1346

Surgical Tools	Catalog No.
Wrench Ratchet Surgical Instruments Handle	RA0050
Surgical Torque Ratchet 35-100 Ncm	RS6111
Depth Probe	RS6180

Paraller Pin	Catalog No.
Parallel Pin Short 11mm (qty. 4)	RS6150
Parallel Pin Long 16mm (qty. 2)	RS6155

Inserion Tools	Catalog No.
NP 2mm Hex Handpiece Adapter - Short	NP0068
NP 2mm Hex Handpiece Adapter - Medium	NP0071
NP 2mm Hex Handpiece Adapter - Long	NP0074
RP 2.25mm Hex Handpiece Adapter - Short	RP0068
RP 2.25mm Hex Handpiece Adapter - Medium	RP0071
RP 2.25mm Hex Handpiece Adapter - Long	RP0074
WP 2.65mm Hex Handpiece Adapter - Short	WP0068
WP 2.65mm Hex Handpiece Adapter - Medium	WP0071
WP 2.65mm Hex Handpiece Adapter - Long	WP0074

Drivers	Catalog No.
Star Hand Driver - Short	RP0064
Star Hand Driver - Long	RP0004

Drill Extension	Catalog No.
Drill Extension	RS9027

\*Products may be ordered separately as an addition to the kit



# Advanced Kit CF6302



Drills	Catalog No.
Pilot Drill 2mmD x 8-18mmL	DL1820
Twist Step Drill 2.3/2.8mmD x 8-18mmL	DL1828
Twist Step Drill 2.8/3.2mmD x 8-18mmL	DL1832
Twist Step Drill 3.2/3.6mmD x 8-18mmL	DL1836
Twist Step Drill 3.6/4.2mmD x 8-18mmL	DL1842
Twist Step Drill 4.2/4.6mmD x 8-18mmL	DL1846

Insertion Tools	Catalog No.
NP 2mm Hex Handpiece Adapter - Short	NP0068
NP 2mm Hex Handpiece Adapter - Medium	NP0071
NP 2mm Hex Handpiece Adapter - Long	NP0074
RP 2.25mm Hex Handpiece Adapter - Short	RP0068
RP 2.25mm Hex Handpiece Adapter - Medium	RP0071
RP 2.25mm Hex Handpiece Adapter - Long	RP0074
WP 2.65mm Hex Handpiece Adapter - Short	WP0068
WP 2.65mm Hex Handpiece Adapter - Medium	WP0071
WP 2.65mm Hex Handpiece Adapter - Long	WP0074

Surgical Tools	Catalog No.
Wrench Ratchet Surgical Instruments Handle	RA0050
Surgical Torque Ratchet 35-100 Ncm	RS6111
Depth Probe	RS6180

Drivers	Catalog No.
Star Hand Driver - Short	RP0064
Star Hand Driver - Long	RP0004

Parallel Pin	Catalog No.
Parallel Pin Short 11mm (qty. 4)	RS6150
Parallel Pin Long 16mm (qty. 2)	RS6155

Drill Extension	Catalog No.
Drill Extension	RS9027

\*The advanced kit is also available with short drills | Catalog No. CF6304

# Starter Kit CF6303



Drills	Catalog No.
Pilot Drill 2mmD x 8-18mmL	DL1820
Twist Step Drill 2.3/2.8mmD x 8-18mmL	DL1828
Twist Step Drill 2.8/3.2mmD x 8-18mmL	DL1832
Twist Step Drill 3.2/3.6mmD x 8-18mmL	DL1836
Twist Step Drill 3.6/4.2mmD x 8-18mmL	DL1842

Insertion Tools	Catalog No.
NP 2mm Hex Handpiece Adapter - Short	NP0068
NP 2mm Hex Handpiece Adapter - Medium	NP0071
NP 2mm Hex Handpiece Adapter - Long	NP0074
RP 2.25mm Hex Handpiece Adapter - Short	RP0068
RP 2.25mm Hex Handpiece Adapter - Medium	RP0071
RP 2.25mm Hex Handpiece Adapter - Long	RP0074
WP 2.65mm Hex Handpiece Adapter - Short	WP0068
WP 2.65mm Hex Handpiece Adapter - Medium	WP0071
WP 2.65mm Hex Handpiece Adapter - Long	WP0074

Surgical Tools	Catalog No.
Wrench Ratchet Surgical Instruments Handle	RA0050
Wrench Ratchet	RS6100

Drivers	Catalog No.
Star Hand Driver - Short	RP0064
Star Hand Driver - Long	RP0004





The adinguide™ was created with you in mind, bringing the guided surgery world to your clinic. The kits were specifically designed to support effortless procedures, accurate and predictable implant placement.

The ActiveFlow™ Irrigation Technology' is a unique design that forces coolant through the guide to ensure irrigation reaches the bone and prevents overheating.

The adinguide™ drills are designed with carved channels which allow saline coolant from your hand-piece to stream through the sleeve directly into the osteotomy site while drilling.

Our uniquely designed drill kit is intuitive and easy to use by implant diameter and length. The Tissue Punch and Pilot Drill allow for easy flapless access.

Keyless procedure enables easy handling and full visibility of surgical field.

**Self-centering drills** – controlled by a 5.5mm / 3.3 mm / 2.0 mm diameter cylinder at the top of each drill centers the drill in the guide's sleeve.

**Self-centering cylinder** engages the sleeve before the drill engages the osteotomy in order to ensure correct positioning of the drill.

**Built-in stoppers** – ensure precise and accurate drilling to the desired depth.



# Guided Surgery Kit



## RS Touareg™, CloseFit™ RP/WP Implants Drills

GSK001



For full guided procedure:



  
CloseFit™ RP/WP  
Implant Platform



GS Accessories  
KIT - RP&WP  
GSK004

  
5.5mmD Sleeve  
GS0055



GS5055 Tissue Punch 5.0mmD, S-5.5



GS0625 Pilot Drill S-5.5, 2.5/1.8mmDx6.0mmL



GS0825 Drill S-5.5, 2.5/1.8mmDx8.0mmL



GS1025 Drill S-5.5, 2.5/1.8mmDx10.0mmL



GS1125 Drill S-5.5, 2.5/1.8mmDx11.5mmL



GS1325 Drill S-5.5, 2.5/1.8mmDx13.0mmL



GS1625 Drill S-5.5, 2.5/1.8mmDx16.0mmL

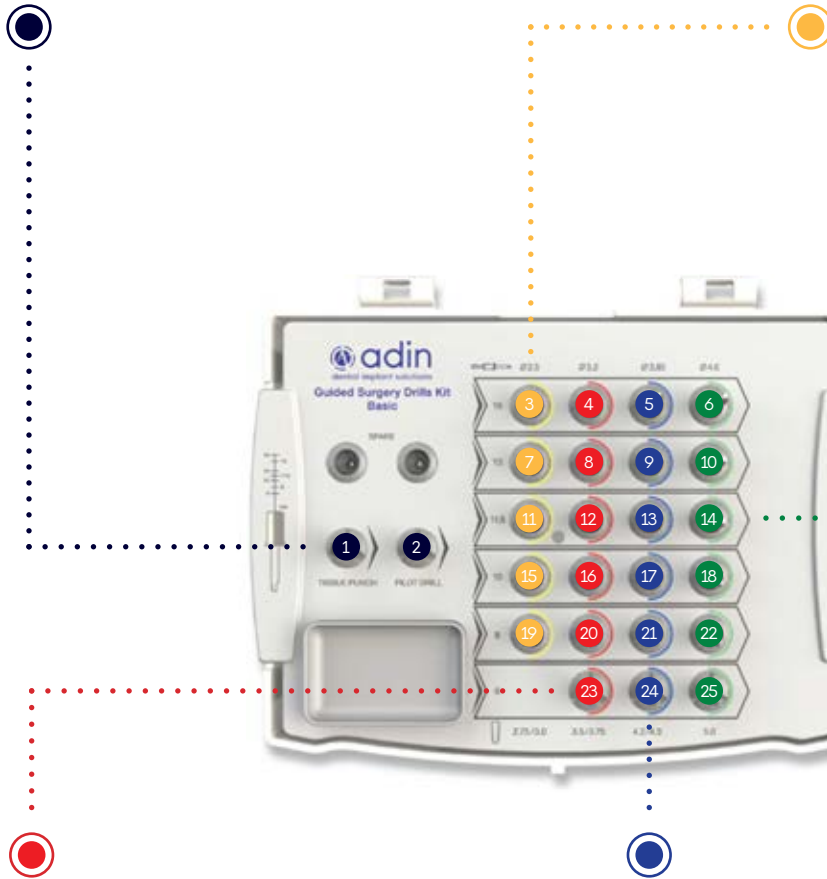

GS0632 Drill S-5.5, 3.2/2.5mmDx6.25mmL



GS0638 Drill S-5.5, 3.85/3.2mmDx6.25mmL



GS0646 Drill S-5.5, 4.6/3.85mmDx6.25mmL



GS0832 Drill S-5.5, 3.2/2.5mmDx8.0mmL



GS0838 Drill S-5.5, 3.85/3.2mmDx8.0mmL



GS0846 Drill S-5.5, 4.6/3.85mmDx8.0mmL



GS1032 Drill S-5.5, 3.2/2.5mmDx10.0mmL



GS1038 Drill S-5.5, 3.85/3.2mmDx10.0mmL



GS1046 Drill S-5.5, 4.6/3.85mmDx10.0mmL



GS1132 Drill S-5.5, 3.2/2.5mmDx11.5mmL



GS1138 Drill S-5.5, 3.85/3.2mmDx11.5mmL



GS1146 Drill S-5.5, 4.6/3.85mmDx11.5mmL



GS1332 Drill S-5.5, 3.2/2.5mmDx13.0mmL



GS1338 Drill S-5.5, 3.85/3.2mmDx13.0mmL



GS1346 Drill S-5.5, 4.6/3.85mmDx13.0mmL



GS1632 Drill S-5.5, 3.2/2.5mmDx16.0mmL



GS1638 Drill S-5.5, 3.85/3.2mmDx16.0mmL



GS1646 Drill S-5.5, 4.6/3.85mmDx16.0mmL



**Guided Surgery Kit**  
**CloseFit™ UNP/NP Narrow Implants Drills & Tools**  
**GSK002**



For full guided procedure:



CloseFit™ UNP/NP  
Narrow Implant Platform



Narrow Implants 3.3mmD Sleeve  
**GS0033**

1 GSN3033 Narrow Tissue Punch 3.0mmD, S-3.3

4 GSN1125 Drill S-3.3, 2.5/1.8mmDx11.5mmL

2 GSN0625 Pilot Drill S-3.3, 2.5/1.8mmDx6.0mmL

5 GSN1325 Drill S-3.3, 2.5/1.8mmDx13.0mmL

3 GSN1025 Drill S-3.3, 2.5/1.8mmDx10.0mmL

6 GSN1625 Drill S-3.3, 2.5/1.8mmDx16.0mmL

7 (for soft bone)  
GS1915 Anchoring Drill  
S-2.0, 2.0/1.5mmDx19mmL

8 (for hard bone)  
GS1917 Anchoring Drill  
S-2.0, 2.0/1.7mmDx19mmL

9 GS0028 Handpiece Guide  
Fixation Screw Driver

22 GS6111 Surgical Torque Ratchet  
35-100 Ncm for hex 4mm

23 GS0027 Guide Fixation Screw  
Driver

10 GS0018 Guided UNP Handpiece  
Fixture Mount S-3.3

13 GS0017 Guided NP Handpiece  
Fixture Mount S-3.3

16 GS0023 Manual Socket L10.5

11 GS0016 Guided UNP Ratchet  
Fixture Mount S-3.3

14 GS0019 Guided NP Ratchet  
Fixture Mount S-3.3

17 GS0024 Manual Socket L14.5

12 GS0014 Guided UNP Ratchet  
Fixture Mount S-3.3, Screw Retained

15 GS0013 Guided NP Ratchet  
Fixture Mount S-3.3, Screw Retained

18 GS0021 Guided Handpiece  
Extension, L10.5

19 RS9027 Drill extension

20 RP0004 Star Hand Driver - Long

21 GS0045 NP&UNP Ratchet retrieval tool







Guided Surgery Kit  
CloseFit™ RP/WP Implants Tools  
GSK004



For full guided procedure:



  
CloseFit™ RP/WP  
Implant Platform



GS Drill Kit  
GSK001



  
5.5mmD Sleeve  
GS0055



GS1915 Anchoring Drill S-2.0, 2.0/1.5mmDx19mmL



GS1917 Anchoring Drill S-2.0, 2.0/1.7mmDx19mmL



GS0028 Handpiece Guide Fixation Screw Driver



GS6111 Surgical Torque Ratchet 35-100 Ncm for hex 4mm



GS0027 Guide Fixation Screw Driver



GS0041 Guided RP Handpiece Fixture Mount S-5.5



GS0043 Guided RP Ratchet Fixture Mount S-5.5



GS0037 Guided RP Ratchet Fixture Mount S-5.5, Screw Retained



GS0046 RP Ratchet retrieval tool



GS0042 Guided WP Handpiece Fixture Mount S-5.5



GS0044 Guided WP Ratchet Fixture Mount S-5.5



GS0039 Guided WP Ratchet Fixture Mount S-5.5, Screw Retained



GS0047 WP Ratchet retrieval tool



GS0023 Manual Socket L10.5



GS0024 Manual Socket L14.5



GS0021 Handpiece Socket L10.5



RS9027 Drill extension



RP0004 Star Hand Driver - Long



# Additional Products

Sold separately

## Accessories



2.0mmD Sleeve

Catalog No. GS0020



Narrow Implants 3.3mmD Sleeve

Catalog No. GS0033



5.5mmD Sleeve

Catalog No. GS0055

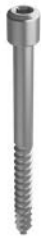

2.0D 19mmL Anchorage Screw

Catalog No. GS1920



Guided Vertical Fixation Screw S-3.3

Catalog No. GS0006



Guided Vertical Fixation Screw S-5.5

Catalog No. GS0007

## | Purchase Options

Catalog No.	Description	Package contents	
GS0006	Guided Vertical Fixation Screw S-3.3		x 3 pack
GS0007	Guided Vertical Fixation Screw S-5.5		x 3 pack
GS1920	2.0mmD Anchoring Screw		x 3 pack
GS0055	5.5mmD Sleeve		x 1 pack
GS0055x3			x 3 pack
GS0055x10			x 10 pack
GS0033	3.3mmD Narrow Implants Sleeve		x 1 pack
GS0033x3			x 3 pack
GS0033x10			x 10 pack
GS0020	2.0mmD Anchoring Sleeve		x 3 pack



## 18mm Drills



Drill S-5.5, 2.5/1.8mmDx18.0mmL

Catalog No. GS1825



Drill S-5.5, 3.2/2.5mmDx18.0mmL

Catalog No. GS1832



Drill S-5.5, 3.85/3.2mmDx18.0mmL

Catalog No. GS1838



Drill S-5.5, 4.6/3.85mmDx18.0mmL

Catalog No. GS1846



Drill S-3.3, 2.5/1.8mmDx18.0mmL

Catalog No. GSN1825



Illustrations are not to scale  
Availability of the products in some places is limited and depends on local regulation.  
For more information, please contact your local representative.





# CAD CAM

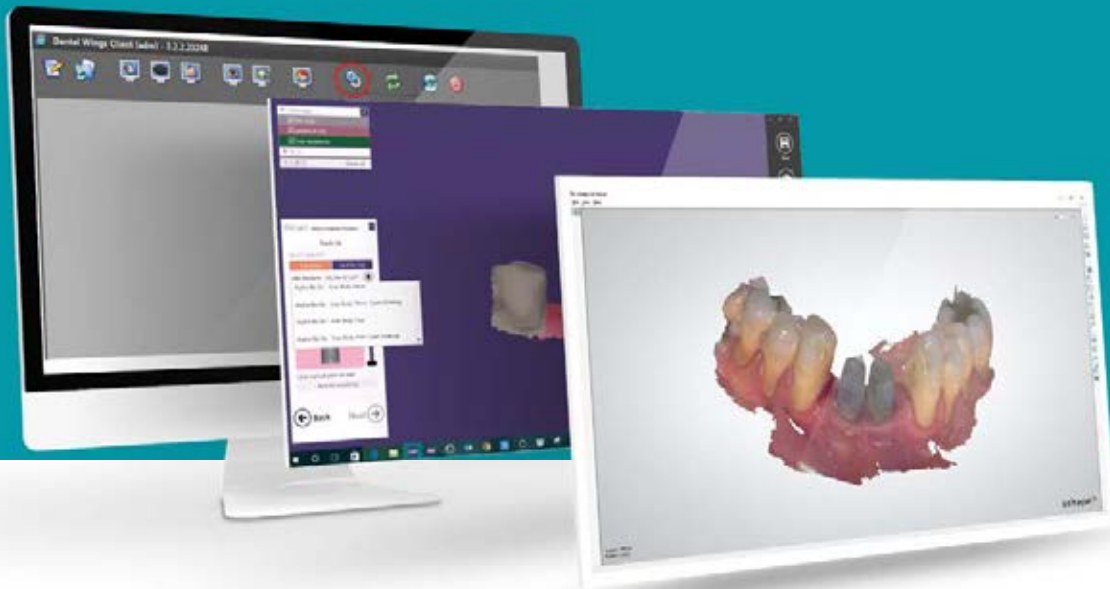

Adin's CAD - CAM components and digital libraries enable dental clinicians and technicians to design and manufacture state-of-the-art restorations supported by Adin's implants, using current and up-to-date digital restoration processes.

The variety of components ensure endless restorative options for treatment of single, multiple, partially, or full edentulous cases.





# NP CloseFit™

Narrow Platform

## Scan body

For Intra-oral and Desktop Scanner

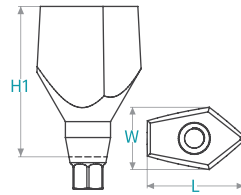

NP CloseFit™  
Scan Body 7mm

NP CloseFit™  
Scan Body 10mm



Catalog No.	NP0088	NP0089
Retaining Screw Included	NP0001	NP0001
Dimensions	H1: 7 mm W: 4.2 mm L: 6.7 mm	H1: 10 mm W: 4.5 mm L: 6.9 mm

## Ti Bases

For screw retained restorations

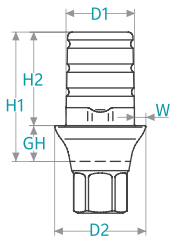

NP CloseFit™  
Ti Base Engaged

NP CloseFit™  
Ti Base Non Engaged

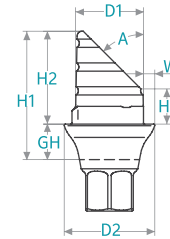

NP CloseFit™  
Ti Base Angular Engaged



Catalog No.	NP1004	NP1008	Catalog No.	NP1017
Retaining Screw Included	NP0001	NP0001	Retaining Screw Included	NP0001
Dimensions	H1: 5.4 mm H2: 3.9 mm — — D1: ø2.9 mm D2: ø3.8 mm W: 0.5 mm GH: 1.5mm	H1: 5.4 mm H2: 3.9 mm — — D1: ø2.9 mm D2: ø3.8 mm W: 0.5 mm GH: 1.5mm	Dimensions	H1: 5.4 mm H2: 3.9 mm H3: 1.5 mm A: 45° D1: ø2.9 mm D2: ø3.8 mm W: 0.5 mm GH: 1.5mm

Intended Use	Single Unit	Bridge	Single Unit / Angle Correction
--------------	-------------	--------	-----------------------------------

## Ti Blanks\*

For Medentika PreFace® Holders

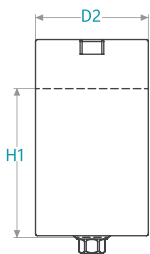

NP CloseFit™  
Ti Pre Milled MDTK  
Abutment Blank  
ø11.5mm

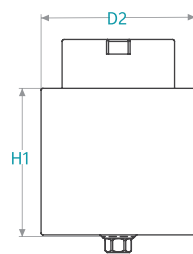

NP CloseFit™  
Ti Pre Milled MDTK  
Abutment Blank  
ø15.8mm



Catalog No.	NP1111	Catalog No.	NP1115
Retaining Screw Included	NP0001	Retaining Screw Included	NP0001
Dimensions	H1: 15.4 mm D2: ø11.5 mm	Dimensions	H1: 15.4 mm D2: ø15.8 mm

Intended Use	customized abutment for single unit	Intended Use	customized abutment for single unit
--------------	--	--------------	--





# UNP CloseFit™

Ultra Narrow Platform

Scan body

For Intra-oral and Desktop Scanner

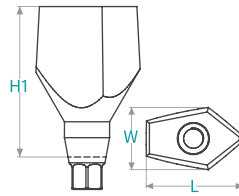

UNP CloseFit™  
Scan Body 7mm

UNP CloseFit™  
Scan Body 10mm



Catalog No.	UNP0088	UNP0089
Retaining Screw Included	UNP0001	UNP0001
Dimensions	H1: 7 mm W: 4.2 mm L: 6.7 mm	H1: 10 mm W: 4.5 mm L: 6.9 mm

Ti Bases

For screw retained restorations

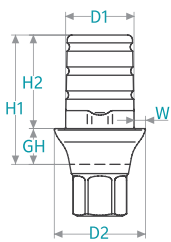

UNP CloseFit™  
Ti Base Engaged

UNP CloseFit™  
Ti Base Non Engaged

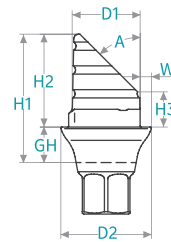

UNP CloseFit™  
Ti Base Angular Engaged



Catalog No.	UNP1704	UNP1708	Catalog No.	UNP1717
Retaining Screw Included	UNP0001	UNP0001	Retaining Screw Included	UNP0001
Dimensions	H1: 5.4 mm H2: 3.9 mm — — D1: $\varnothing$ 2.9 mm D2: $\varnothing$ 3.8 mm W: 0.5 mm GH: 1.5 mm	H1: 5.4 mm H2: 3.9 mm — — D1: $\varnothing$ 2.9 mm D2: $\varnothing$ 3.8 mm W: 0.5 mm GH: 1.5 mm	Dimensions	H1: 5.4 mm H2: 3.9 mm H3: 1.5 mm A: 45° D1: $\varnothing$ 2.9 mm D2: $\varnothing$ 3.8 mm W: 0.5 mm GH: 1.5 mm
Intended Use	Single Unit	Bridge	Intended Use	Single Unit / Angle Correction

Ti Blanks\*

For Medentika PreFace® Holders

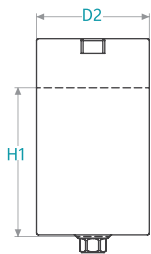

UNP CloseFit™  
Ti Pre Milled MDTK  
Abutment Blank  
 $\varnothing$ 11.5mm

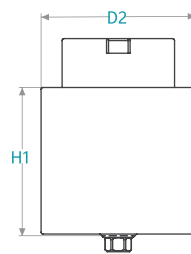

UNP CloseFit™  
Ti Pre Milled MDTK  
Abutment Blank  
 $\varnothing$ 15.8mm



Catalog No.	UNP1711	Catalog No.	UNP1715
Retaining Screw Included	UNP0001	Retaining Screw Included	UNP0001
Dimensions	H1: 15.4 mm D2: $\varnothing$ 11.5 mm	Dimensions	H1: 15.4 mm D2: $\varnothing$ 15.8 mm
Intended Use	customized abutment for single unit	Intended Use	customized abutment for single unit



# RP CloseFit™

Regular Platform

Scan body

For Intra-oral and Desktop Scanner

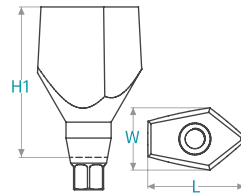

RP CloseFit™  
Scan Body 7mm

RP CloseFit™  
Scan Body 10mm



Catalog No.	RP0088	RP0089
Retaining Screw Included	RP0001	RP0001
Dimensions	H1: 7 mm W: 4.3 mm L: 6.7 mm	H1: 10 mm W: 4.5 mm L: 6.9 mm

Ti Bases

For screw retained restorations

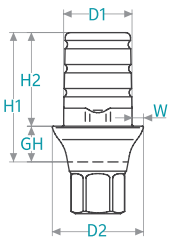

RP CloseFit™  
Ti Base Engaged

RP CloseFit™  
Ti Base Non Engaged

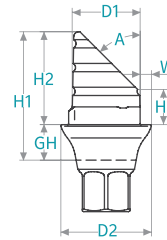

RP CloseFit™  
Ti Base Angular Engaged



Catalog No.	RP1204	RP1208	Catalog No.	RP1217
Retaining Screw Included	RP0001	RP0001	Retaining Screw Included	RP0001
Dimensions	H1: 4.9 mm H2: 3.9 mm — — D1: ø3.3 mm D2: ø4.5mm W: 0.6mm GH: 1.0mm	H1: 4.9 mm H2: 3.9 mm — — D1: ø3.3 mm D2: ø4.5mm W: 0.6mm GH: 1.0mm	Dimensions	H1: 4.9 mm H2: 3.9 mm H3: 1.5 mm A: 48° D1: ø3.3 mm D2: ø4.5 mm W: 0.6 mm GH: 1.0mm
Intended Use	Single Unit	Bridge	Intended Use	Single Unit / Angle Correction

Ti Blanks\*

For Medentika PreFace® Holders

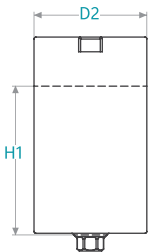

RP CloseFit™  
Ti Pre Milled MDTK  
Abutment Blank  
ø11.5mm

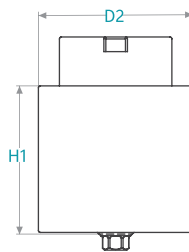

RP CloseFit™  
Ti Pre Milled MDTK  
Abutment Blank  
ø15.8mm



Catalog No.	RP1211	Catalog No.	RP1215
Retaining Screw Included	RP0001	Retaining Screw Included	RP0001
Dimensions	H1: 15.2mm D2: ø11.5 mm	Dimensions	H1: 15.2mm D2: ø15.8 mm
Intended Use	customized abutment for single unit	Intended Use	customized abutment for single unit



# WP CloseFit™

Wide Platform

## Scan body

For Intra-oral and Desktop Scanner

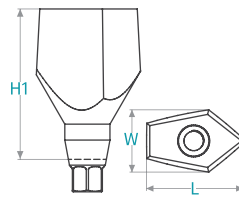

WP CloseFit™  
Scan Body 7mm

WP CloseFit™  
Scan Body 10mm



Catalog No.	WP0088	WP0089
Retaining Screw Included	WP0001	WP0001
Dimensions	H1: 7 mm W: 4.3 mm L: 6.7 mm	H1: 10 mm W: 4.5 mm L: 6.9 mm

## Ti Bases

For screw retained restorations

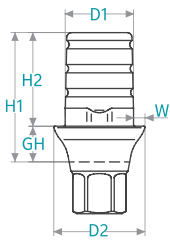

WP CloseFit™  
Ti Base Engaged

WP CloseFit™  
Ti Base Non Engaged

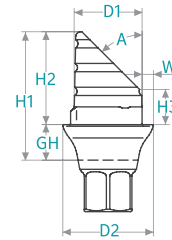

WP CloseFit™  
Ti Base Angular Engaged



Catalog No.	WP1304	WP1308	Catalog No.	WP1317
Retaining Screw Included	WP0001	WP0001	Retaining Screw Included	WP0001
Dimensions	H1: 4.7 mm H2: 3.9 mm — — D1: ø3.5 mm D2: ø4.5 mm W: 0.5 mm GH: 0.8 mm	H1: 4.7 mm H2: 3.9 mm — — D1: ø3.5 mm D2: ø4.5 mm W: 0.5 mm GH: 0.8 mm	Dimensions	H1: 4.7 mm H2: 3.9 mm H3: 1.5 mm A: 51.5° D1: ø3.5 mm D2: ø4.5 mm W: 0.5 mm GH: 0.8 mm
Intended Use	Single Unit	Bridge	Intended Use	Single Unit / Angle Correction

## Ti Blanks\*

For Medentika PreFace® Holders

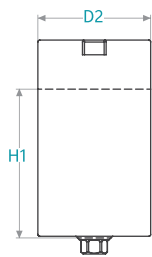

WP CloseFit™  
Ti Pre Milled MDTK  
Abutment Blank  
ø11.5mm

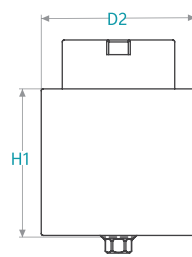

WP CloseFit™  
Ti Pre Milled MDTK  
Abutment Blank  
ø15.8mm



Catalog No.	WP1311	Catalog No.	WP1315
Retaining Screw Included	WP0001	Retaining Screw Included	WP0001
Dimensions	H1: 15.2 mm D2: ø11.5 mm	Dimensions	H1: 15.2 mm D2: ø15.8 mm
Intended Use	customized abutment for single unit	Intended Use	customized abutment for single unit



# Digital Analogs

Recommended Torque 15(Ncm)

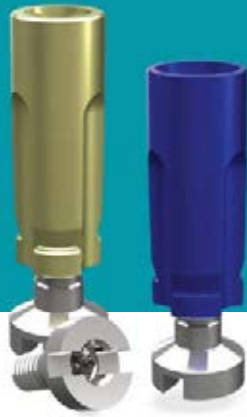

Digital Analog	UNP CloseFit™ Implant Analog	NP CloseFit™ Implant Analog	RP CloseFit™ Implant Analog	WP CloseFit™ Implant Analog
				
Catalog No.	UNP1000	NP1000	RP1000	WP1000

## Retaining Screw for Digital Analog



Catalog No.	RS1002
-------------	--------

Tool driver	1.27 Hex Hand Driver - Short	1.27 Hex Hand Driver - Medium
		
Catalog No.	RS6095	RS6094



# Screws & TMA

## Screws

UNP CloseFit™  
Abutment Screw

NP CloseFit™  
Abutment Screw

RP CloseFit™  
Abutment Screw

WP CloseFit™  
Abutment Screw



Catalog No.	UNP0001	NP0001	RP0001	WP0001
Intended use	For UNP Scan Body, Ti Bases & Blanks	For NP Scan Body, Ti Bases & Blanks	For RP Scan Body, Ti Bases & Blanks	For WP Scan Body, Ti Bases & Blanks

## TMA - Multi Unit

TMA  
Scan Body Screw

TMA  
Prosthetic Screw



Catalog No.	TM0001	RS3404
Intended use	For TMA-MU Scan Body & Cementing Cone	For TMA-MU Temporary cylinder & TMA direct option





## Ti Base Coming soon

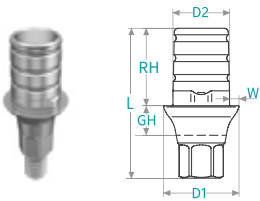

### CloseFit™ UNP

Engaged	RH	GH	D1	D2	L	W	Catalog No.
Ti Base UNP Abutment, RH 4mm GH 1.5mm Engaged	4	1.5	4.1	3.1	7.8	0.5	TB06411
Ti Base UNP Abutment, RH 4mm GH 2mm Engaged	4	2	4.1	3.1	8.3	0.5	TB06421
Ti Base UNP Abutment, RH 4mm GH 3mm Engaged	4	3	4.1	3.1	9.3	0.5	TB06431
Ti Base UNP Abutment, RH 4mm GH 4mm Engaged	4	4	4.1	3.1	10.3	0.5	TB06441
Ti Base UNP Abutment, RH 6mm GH 1.5mm Engaged	6	1.5	4.1	3.1	9.8	0.5	TB06611
Ti Base UNP Abutment, RH 6mm GH 2mm Engaged	6	2	4.1	3.1	10.3	0.5	TB06621
Ti Base UNP Abutment, RH 6mm GH 3mm Engaged	6	3	4.1	3.1	11.3	0.5	TB06631
Ti Base UNP Abutment, RH 6mm GH 4mm Engaged	6	4	4.1	3.1	12.3	0.5	TB06641
Ti Base UNP Abutment, RH 8mm GH 1.5mm Engaged	8	1.5	4.1	3.1	11.8	0.5	TB06811
Ti Base UNP Abutment, RH 8mm GH 2mm Engaged	8	2	4.1	3.1	12.3	0.5	TB06821

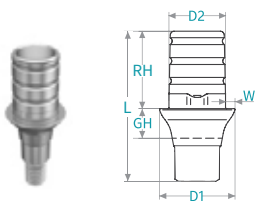

Non Engaged	RH	GH	D1	D2	L	W	Catalog No.
Ti Base UNP Abutment, RH 4mm GH 1.5mm Non Engaged	4	1.5	4.1	3.1	6.8	0.5	TB06412
Ti Base UNP Abutment, RH 4mm GH 2mm Non Engaged	4	2	4.1	3.1	7.3	0.5	TB06422
Ti Base UNP Abutment, RH 4mm GH 3mm Non Engaged	4	3	4.1	3.1	8.3	0.5	TB06432
Ti Base UNP Abutment, RH 4mm GH 4mm Non Engaged	4	4	4.1	3.1	9.3	0.5	TB06442
Ti Base UNP Abutment, RH 6mm GH 1.5mm Non Engaged	6	1.5	4.1	3.1	8.8	0.5	TB06612
Ti Base UNP Abutment, RH 6mm GH 2mm Non Engaged	6	2	4.1	3.1	9.3	0.5	TB06622
Ti Base UNP Abutment, RH 6mm GH 3mm Non Engaged	6	3	4.1	3.1	10.3	0.5	TB06632

Non Engaged	RH	GH	D1	D2	L	W	Catalog No.
Ti Base UNP Abutment, RH 6mm GH 4mm Non Engaged	6	4	4.1	3.1	11.3	0.5	TB06642
Ti Base UNP Abutment, RH 8mm GH 1.5mm Non Engaged	8	1.5	4.1	3.1	10.8	0.5	TB06812
Ti Base UNP Abutment, RH 8mm GH 2mm Non Engaged	8	2	4.1	3.1	11.3	0.5	TB06822

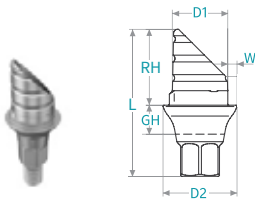

Angular Engaged	RH	GH	D1	D2	L	W	Catalog No.
Ti Base UNP Abutment, RH 4mm GH 1.5mm Angular Engaged	4	1.5	4.1	3.1	7.8	0.5	TB06413
Ti Base UNP Abutment, RH 4mm GH 2mm Angular Engaged	4	2	4.1	3.1	8.3	0.5	TB06423
Ti Base UNP Abutment, RH 4mm GH 3mm Angular Engaged	4	3	4.1	3.1	9.3	0.5	TB06433
Ti Base UNP Abutment, RH 4mm GH 4mm Angular Engaged	4	4	4.1	3.1	10.3	0.5	TB06443
Ti Base UNP Abutment, RH 6mm GH 1.5mm Angular Engaged	6	1.5	4.1	3.1	9.8	0.5	TB06613
Ti Base UNP Abutment, RH 6mm GH 2mm Angular Engaged	6	2	4.1	3.1	10.3	0.5	TB06623
Ti Base UNP Abutment, RH 6mm GH 3mm Angular Engaged	6	3	4.1	3.1	11.3	0.5	TB06633
Ti Base UNP Abutment, RH 6mm GH 4mm Angular Engaged	6	4	4.1	3.1	12.3	0.5	TB06643
Ti Base UNP Abutment, RH 8mm GH 1.5mm Angular Engaged	8	1.5	4.1	3.1	11.8	0.5	TB06813
Ti Base UNP Abutment, RH 8mm GH 2mm Angular Engaged	8	2	4.1	3.1	12.3	0.5	TB06823

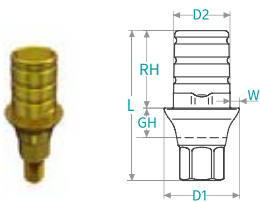

CloseFit™ NP

Engaged	RH	GH	D1	D2	L	W	Catalog No.
Ti Base NP Abutment, RH 4mm GH 1.5mm Engaged	4	1.5	4.1	3.1	7.7	0.5	TB02411
Ti Base NP Abutment, RH 4mm GH 2mm Engaged	4	2	4.1	3.1	8.2	0.5	TB02421
Ti Base NP Abutment, RH 4mm GH 3mm Engaged	4	3	4.1	3.1	9.2	0.5	TB02431
Ti Base NP Abutment, RH 4mm GH 4mm Engaged	4	4	4.1	3.1	10.2	0.5	TB02441
Ti Base NP Abutment, RH 6mm GH 1.5mm Engaged	6	1.5	4.1	3.1	9.7	0.5	TB02611
Ti Base NP Abutment, RH 6mm GH 2mm Engaged	6	2	4.1	3.1	10.2	0.5	TB02621
Ti Base NP Abutment, RH 6mm GH 3mm Engaged	6	3	4.1	3.1	11.2	0.5	TB02631

Engaged	RH	GH	D1	D2	L	W	Catalog No.
Ti Base NP Abutment, RH 6mm GH 4mm Engaged	6	4	4.1	3.1	12.2	0.5	TB02641
Ti Base NP Abutment, RH 8mm GH 1.5mm Engaged	8	1.5	4.1	3.1	11.7	0.5	TB02811
Ti Base NP Abutment, RH 8mm GH 2mm Engaged	8	2	4.1	3.1	12.2	0.5	TB02821

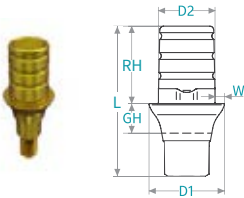

Non Engaged	RH	GH	D1	D2	L	W	Catalog No.
Ti Base NP Abutment, RH 4mm GH 1.5mm Non Engaged	4	1.5	4.1	3.1	6.7	0.5	TB02412
Ti Base NP Abutment, RH 4mm GH 2mm Non Engaged	4	2	4.1	3.1	7.2	0.5	TB02422
Ti Base NP Abutment, RH 4mm GH 3mm Non Engaged	4	3	4.1	3.1	8.2	0.5	TB02432
Ti Base NP Abutment, RH 4mm GH 4mm Non Engaged	4	4	4.1	3.1	9.2	0.5	TB02442
Ti Base NP Abutment, RH 6mm GH 1.5mm Non Engaged	6	1.5	4.1	3.1	8.7	0.5	TB02612
Ti Base NP Abutment, RH 6mm GH 2mm Non Engaged	6	2	4.1	3.1	9.2	0.5	TB02622
Ti Base NP Abutment, RH 6mm GH 3mm Non Engaged	6	3	4.1	3.1	10.2	0.5	TB02632
Ti Base NP Abutment, RH 6mm GH 4mm Non Engaged	6	4	4.1	3.1	11.2	0.5	TB02642
Ti Base NP Abutment, RH 8mm GH 1.5mm Non Engaged	8	1.5	4.1	3.1	10.7	0.5	TB02812
Ti Base NP Abutment, RH 8mm GH 2mm Non Engaged	8	2	4.1	3.1	11.2	0.5	TB02822

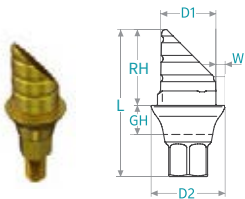

Angular Engaged	RH	GH	D1	D2	L	W	Catalog No.
Ti Base NP Abutment, RH 4mm GH 1.5mm Angular Engaged	4	1.5	4.1	3.1	7.7	0.5	TB02413
Ti Base NP Abutment, RH 4mm GH 2mm Angular Engaged	4	2	4.1	3.1	8.2	0.5	TB02423
Ti Base NP Abutment, RH 4mm GH 3mm Angular Engaged	4	3	4.1	3.1	9.2	0.5	TB02433
Ti Base NP Abutment, RH 4mm GH 4mm Angular Engaged	4	4	4.1	3.1	10.2	0.5	TB02443
Ti Base NP Abutment, RH 6mm GH 1.5mm Angular Engaged	6	1.5	4.1	3.1	9.7	0.5	TB02613
Ti Base NP Abutment, RH 6mm GH 2mm Angular Engaged	6	2	4.1	3.1	10.2	0.5	TB02623
Ti Base NP Abutment, RH 6mm GH 3mm Angular Engaged	6	3	4.1	3.1	11.2	0.5	TB02633



Angular Engaged	RH	GH	D1	D2	L	W	Catalog No.
Ti Base NP Abutment, RH 6mm GH 4mm Angular Engaged	6	4	4.1	3.1	12.2	0.5	TB02643
Ti Base NP Abutment, RH 8mm GH 1.5mm Angular Engaged	8	1.5	4.1	3.1	11.7	0.5	TB02813
Ti Base NP Abutment, RH 8mm GH 2mm Angular Engaged	8	2	4.1	3.1	12.2	0.5	TB02823

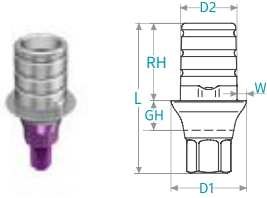

CloseFit™ RP

Engaged	RH	GH	D1	D2	L	W	Catalog No.
Ti Base RP Abutment, RH 4mm GH 1mm Engaged	4	1	4.5	3.5	7.2	0.5	TB03411
Ti Base RP Abutment, RH 4mm GH 2mm Engaged	4	2	4.5	3.5	8.2	0.5	TB03421
Ti Base RP Abutment, RH 4mm GH 3mm Engaged	4	3	4.5	3.5	9.2	0.5	TB03431
Ti Base RP Abutment, RH 4mm GH 4mm Engaged	4	4	4.5	3.5	10.2	0.5	TB03441
Ti Base RP Abutment, RH 6mm GH 1mm Engaged	6	1	4.5	3.5	9.2	0.5	TB03611
Ti Base RP Abutment, RH 6mm GH 2mm Engaged	6	2	4.5	3.5	10.2	0.5	TB03621
Ti Base RP Abutment, RH 6mm GH 3mm Engaged	6	3	4.5	3.5	11.2	0.5	TB03631
Ti Base RP Abutment, RH 6mm GH 4mm Engaged	6	4	4.5	3.5	12.2	0.5	TB03641
Ti Base RP Abutment, RH 8mm GH 1mm Engaged	8	1	4.5	3.5	11.2	0.5	TB03811
Ti Base RP Abutment, RH 8mm GH 2mm Engaged	8	2	4.5	3.5	12.2	0.5	TB03821
Ti Base RP Abutment, RH 8mm GH 3mm Engaged	8	3	4.5	3.5	13.2	0.5	TB03831
Ti Base RP Abutment, RH 8mm GH 4mm Engaged	8	4	4.5	3.5	14.2	0.5	TB03841

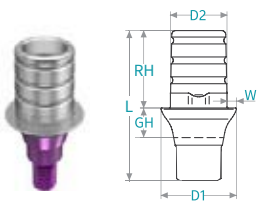

Non Engaged	RH	GH	D1	D2	L	W	Catalog No.
Ti Base RP Abutment, RH 4mm GH 1mm Non Engaged	4	1	4.5	3.5	6.5	0.5	TB03412
Ti Base RP Abutment, RH 4mm GH 2mm Non Engaged	4	2	4.5	3.5	7.5	0.5	TB03422
Ti Base RP Abutment, RH 4mm GH 3mm Non Engaged	4	3	4.5	3.5	8.5	0.5	TB03432
Ti Base RP Abutment, RH 4mm GH 4mm Non Engaged	4	4	4.5	3.5	9.5	0.5	TB03442
Ti Base RP Abutment, RH 6mm GH 1mm Non Engaged	6	1	4.5	3.5	8.5	0.5	TB03612
Ti Base RP Abutment, RH 6mm GH 2mm Non Engaged	6	2	4.5	3.5	9.5	0.5	TB03622
Ti Base RP Abutment, RH 6mm GH 3mm Non Engaged	6	3	4.5	3.5	10.5	0.5	TB03632

Non Engaged	RH	GH	D1	D2	L	W	Catalog No.
Ti Base RP Abutment, RH 6mm GH 4mm Non Engaged	6	4	4.5	3.5	11.5	0.5	TB03642
Ti Base RP Abutment, RH 8mm GH 1mm Non Engaged	8	1	4.5	3.5	10.5	0.5	TB03812
Ti Base RP Abutment, RH 8mm GH 2mm Non Engaged	8	2	4.5	3.5	11.5	0.5	TB03822
Ti Base RP Abutment, RH 8mm GH 3mm Non Engaged	8	3	4.5	3.5	12.5	0.5	TB03832
Ti Base RP Abutment, RH 8mm GH 4mm Non Engaged	8	4	4.5	3.5	13.5	0.5	TB03842

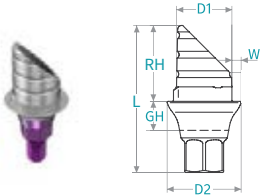

Angular Engaged	RH	GH	D1	D2	L	W	Catalog No.
Ti Base RP Abutment, RH 4mm GH 1mm Angular Engaged	4	1	4.5	3.5	7.2	0.5	TB03413
Ti Base RP Abutment, RH 4mm GH 2mm Angular Engaged	4	2	4.5	3.5	8.2	0.5	TB03423
Ti Base RP Abutment, RH 4mm GH 3mm Angular Engaged	4	3	4.5	3.5	9.2	0.5	TB03433
Ti Base RP Abutment, RH 4mm GH 4mm Angular Engaged	4	4	4.5	3.5	10.2	0.5	TB03443
Ti Base RP Abutment, RH 6mm GH 1mm Angular Engaged	6	1	4.5	3.5	9.2	0.5	TB03613
Ti Base RP Abutment, RH 6mm GH 2mm Angular Engaged	6	2	4.5	3.5	10.2	0.5	TB03623
Ti Base RP Abutment, RH 6mm GH 3mm Angular Engaged	6	3	4.5	3.5	11.2	0.5	TB03633
Ti Base RP Abutment, RH 6mm GH 4mm Angular Engaged	6	4	4.5	3.5	12.2	0.5	TB03643
Ti Base RP Abutment, RH 8mm GH 1mm Angular Engaged	8	1	4.5	3.5	11.2	0.5	TB03813
Ti Base RP Abutment, RH 8mm GH 2mm Angular Engaged	8	2	4.5	3.5	12.2	0.5	TB03823
Ti Base RP Abutment, RH 8mm GH 3mm Angular Engaged	8	3	4.5	3.5	13.2	0.5	TB03833
Ti Base RP Abutment, RH 8mm GH 4mm Angular Engaged	8	4	4.5	3.5	14.2	0.5	TB03843

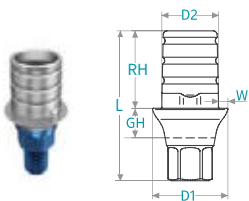

CloseFit™ WP

Engaged	RH	GH	D1	D2	L	W	Catalog No.
Ti Base WP Abutment, RH 4mm GH 1mm Engaged	4	1	4.7	3.7	7.3	0.5	TB05411
Ti Base WP Abutment, RH 4mm GH 2mm Engaged	4	2	4.7	3.7	8.3	0.5	TB05421
Ti Base WP Abutment, RH 4mm GH 3mm Engaged	4	3	4.7	3.7	9.3	0.5	TB05431
Ti Base WP Abutment, RH 4mm GH 4mm Engaged	4	4	4.7	3.7	10.3	0.5	TB05441
Ti Base WP Abutment, RH 6mm GH 1mm Engaged	6	1	4.7	3.7	9.3	0.5	TB05611
Ti Base WP Abutment, RH 6mm GH 2mm Engaged	6	2	4.7	3.7	10.3	0.5	TB05621
Ti Base WP Abutment, RH 6mm GH 3mm Engaged	6	3	4.7	3.7	11.3	0.5	TB05631
Ti Base WP Abutment, RH 6mm GH 4mm Engaged	6	4	4.7	3.7	12.3	0.5	TB05641

Engaged	RH	GH	D1	D2	L	W	Catalog No.
Ti Base WP Abutment, RH 8mm GH 1mm Engaged	8	1	4.7	3.7	11.3	0.5	TB05811
Ti Base WP Abutment, RH 8mm GH 2mm Engaged	8	2	4.7	3.7	12.3	0.5	TB05821
Ti Base WP Abutment, RH 8mm GH 3mm Engaged	8	3	4.7	3.7	13.3	0.5	TB05831
Ti Base WP Abutment, RH 8mm GH 4mm Engaged	8	4	4.7	3.7	14.3	0.5	TB05841

Engaged Wide	RH	GH	D1	D2	L	W	Catalog No.
Ti Base WP Abutment, RH 4mm GH 1mm Engaged, Wide	4	1	5.5	3.7	7.3	0.9	TB05411W
Ti Base WP Abutment, RH 4mm GH 2mm Engaged Wide	4	2	5.5	3.7	8.3	0.9	TB05421W
Ti Base WP Abutment, RH 4mm GH 3mm Engaged Wide	4	3	5.5	3.7	9.3	0.9	TB05431W
Ti Base WP Abutment, RH 4mm GH 4mm Engaged Wide	4	4	5.5	3.7	10.3	0.9	TB05441W
Ti Base WP Abutment, RH 6mm GH 1mm Engaged Wide	6	1	5.5	3.7	9.3	0.9	TB05611W
Ti Base WP Abutment, RH 6mm GH 2mm Engaged Wide	6	2	5.5	3.7	10.3	0.9	TB05621W
Ti Base WP Abutment, RH 6mm GH 3mm Engaged Wide	6	3	5.5	3.7	11.3	0.9	TB05631W
Ti Base WP Abutment, RH 6mm GH 4mm Engaged Wide	6	4	5.5	3.7	12.3	0.9	TB05641W
Ti Base WP Abutment, RH 8mm GH 1mm Engaged Wide	8	1	5.5	3.7	11.3	0.9	TB05811W
Ti Base WP Abutment, RH 8mm GH 2mm Engaged Wide	8	2	5.5	3.7	12.3	0.9	TB05821W
Ti Base WP Abutment, RH 8mm GH 3mm Engaged Wide	8	3	5.5	3.7	13.3	0.9	TB05831W
Ti Base WP Abutment, RH 8mm GH 4mm Engaged Wide	8	4	5.5	3.7	14.3	0.9	TB05841W

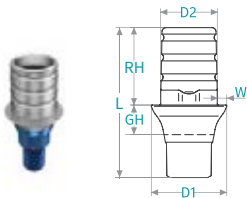

Non Engaged	RH	GH	D1	D2	L	W	Catalog No.
Ti Base WP Abutment, RH 4mm GH 1mm Non Engaged	4	1	4.7	3.7	6.6	0.5	TB05412
Ti Base WP Abutment, RH 4mm GH 2mm Non Engaged	4	2	4.7	3.7	7.6	0.5	TB05422
Ti Base WP Abutment, RH 4mm GH 3mm Non Engaged	4	3	4.7	3.7	8.6	0.5	TB05432
Ti Base WP Abutment, RH 4mm GH 4mm Non Engaged	4	4	4.7	3.7	9.6	0.5	TB05442
Ti Base WP Abutment, RH 6mm GH 1mm Non Engaged	6	1	4.7	3.7	8.6	0.5	TB05612
Ti Base WP Abutment, RH 6mm GH 2mm Non Engaged	6	2	4.7	3.7	9.6	0.5	TB05622
Ti Base WP Abutment, RH 6mm GH 3mm Non Engaged	6	3	4.7	3.7	10.6	0.5	TB05632
Ti Base WP Abutment, RH 6mm GH 4mm Non Engaged	6	4	4.7	3.7	11.6	0.5	TB05642
Ti Base WP Abutment, RH 8mm GH 1mm Non Engaged	8	1	4.7	3.7	10.6	0.5	TB05812
Ti Base WP Abutment, RH 8mm GH 2mm Non Engaged	8	2	4.7	3.7	11.6	0.5	TB05822

Non Engaged	RH	GH	D1	D2	L	W	Catalog No.
Ti Base WP Abutment, RH 8mm GH 3mm Non Engaged	8	3	4.7	3.7	12.6	0.5	TB05832
Ti Base WP Abutment, RH 8mm GH 4mm Non Engaged	8	4	4.7	3.7	13.6	0.5	TB05842

Non Engaged Wide	RH	GH	D1	D2	L	W	Catalog No.
Ti Base WP Abutment, RH 4mm GH 1mm Non Engaged Wide	4	1	5.5	3.7	6.6	0.9	TB05412W
Ti Base WP Abutment, RH 4mm GH 2mm Non Engaged Wide	4	2	5.5	3.7	7.6	0.9	TB05422W
Ti Base WP Abutment, RH 4mm GH 3mm Non Engaged Wide	4	3	5.5	3.7	8.6	0.9	TB05432W
Ti Base WP Abutment, RH 4mm GH 4mm Non Engaged Wide	4	4	5.5	3.7	9.6	0.9	TB05442W
Ti Base WP Abutment, RH 6mm GH 1mm Non Engaged Wide	6	1	5.5	3.7	8.6	0.9	TB05612W
Ti Base WP Abutment, RH 6mm GH 2mm Non Engaged Wide	6	2	5.5	3.7	9.6	0.9	TB05622W
Ti Base WP Abutment, RH 6mm GH 3mm Non Engaged Wide	6	3	5.5	3.7	10.6	0.9	TB05632W
Ti Base WP Abutment, RH 6mm GH 4mm Non Engaged Wide	6	4	5.5	3.7	11.6	0.9	TB05642W
Ti Base WP Abutment, RH 8mm GH 1mm Non Engaged Wide	8	1	5.5	3.7	10.6	0.9	TB05812W
Ti Base WP Abutment, RH 8mm GH 2mm Non Engaged Wide	8	2	5.5	3.7	11.6	0.9	TB05822W
Ti Base WP Abutment, RH 8mm GH 3mm Non Engaged Wide	8	3	5.5	3.7	12.6	0.9	TB05832W
Ti Base WP Abutment, RH 8mm GH 4mm Non Engaged Wide	8	4	5.5	3.7	13.6	0.9	TB05842W

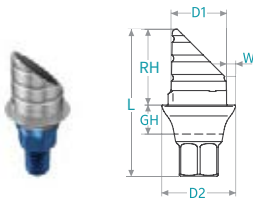

Angular Engaged	RH	GH	D1	D2	L	W	Catalog No.
Ti Base WP Abutment, RH 4mm GH 1mm Angular Engaged	4	1	4.7	3.7	7.3	0.5	TB05413
Ti Base WP Abutment, RH 4mm GH 2mm Angular Engaged	4	2	4.7	3.7	8.3	0.5	TB05423
Ti Base WP Abutment, RH 4mm GH 3mm Angular Engaged	4	3	4.7	3.7	9.3	0.5	TB05433
Ti Base WP Abutment, RH 4mm GH 4mm Angular Engaged	4	4	4.7	3.7	10.3	0.5	TB05443
Ti Base WP Abutment, RH 6mm GH 1mm Angular Engaged	6	1	4.7	3.7	9.3	0.5	TB05613
Ti Base WP Abutment, RH 6mm GH 3mm Angular Engaged	6	3	4.7	3.7	11.3	0.5	TB05633
Ti Base WP Abutment, RH 6mm GH 4mm Angular Engaged	6	4	4.7	3.7	12.3	0.5	TB05643
Ti Base WP Abutment, RH 8mm GH 1mm Angular Engaged	8	1	4.7	3.7	11.3	0.5	TB05813
Ti Base WP Abutment, RH 8mm GH 2mm Angular Engaged	8	2	4.7	3.7	12.3	0.5	TB05823
Ti Base WP Abutment, RH 8mm GH 3mm Angular Engaged	8	3	4.7	3.7	13.3	0.5	TB05833
Ti Base WP Abutment, RH 8mm GH 4mm Angular Engaged	8	4	4.7	3.7	14.3	0.5	TB05843

Angular Engaged Wide	RH	GH	D1	D2	L	W	Catalog No.
Ti Base WP Abutment, RH 4mm GH 1mm Angular Engaged Wide	4	1	5.5	3.7	7.3	0.9	TB05413W
Ti Base WP Abutment, RH 4mm GH 2mm Angular Engaged Wide	4	2	5.5	3.7	8.3	0.9	TB05423W
Ti Base WP Abutment, RH 4mm GH 3mm Angular Engaged Wide	4	3	5.5	3.7	9.3	0.9	TB05433W
Ti Base WP Abutment, RH 4mm GH 4mm Angular Engaged Wide	4	4	5.5	3.7	10.3	0.9	TB05443W
Ti Base WP Abutment, RH 6mm GH 1mm Angular Engaged Wide	6	1	5.5	3.7	9.3	0.9	TB05613W
Ti Base WP Abutment, RH 6mm GH 2mm Angular Engaged Wide	6	2	5.5	3.7	10.3	0.9	TB05623W
Ti Base WP Abutment, RH 6mm GH 3mm Angular Engaged Wide	6	3	5.5	3.7	11.3	0.9	TB05633W
Ti Base WP Abutment, RH 6mm GH 4mm Angular Engaged Wide	6	4	5.5	3.7	12.3	0.9	TB05643W
Ti Base WP Abutment, RH 8mm GH 1mm Angular Engaged Wide	8	1	5.5	3.7	11.3	0.9	TB05813W
Ti Base WP Abutment, RH 8mm GH 2mm Angular Engaged Wide	8	2	5.5	3.7	12.3	0.9	TB05823W
Ti Base WP Abutment, RH 8mm GH 3mm Angular Engaged Wide	8	3	5.5	3.7	13.3	0.9	TB05833W
Ti Base WP Abutment, RH 8mm GH 4mm Angular Engaged Wide	8	4	5.5	3.7	14.3	0.9	TB05843W



# One™

One piece implants







One™



Our One™ implant system is a unique Monoblock solution designed for fast, convenient and immediate restoration, with minimal or no abutment preparation.

Featuring an integrated superstructure, the system's main advantage is the complete elimination of microbial leakage and colonization between implant and abutment, which leads to minimal gingival resorption.

One™ narrow diameter implants are also highly suitable replacements for sites with limited interdental dimensions, such as maxillary lateral and mandibular incisors.

Implant packed with

Additional part



One Piece Torque Driver - Short  
RS6025



One Piece Torque Driver - Long  
RS6026



Recommended insertion torque up to 50 Ncm

	Ø	L	D3	Catalog No.
	3.0	10.00	2.30	IO1030
		11.50	2.30	IO1130
		13.00	2.30	IO1330
		15.00	2.30	IO1530
	3.3	10.00	2.60	IO1033
		11.50	2.60	IO1133
		13.00	2.60	IO1333
		15.00	2.60	IO1533
	3.6	10.00	2.90	IO1036
		11.50	2.90	IO1136
		13.00	2.90	IO1336
		15.00	2.90	IO1536
	4.2	10.00	3.30	IO1042
		11.50	3.30	IO1142
		13.00	3.30	IO1342
		15.00	3.30	IO1542
	5.0	10.00	4.10	IO1050
		11.50	4.10	IO1150
		13.00	4.10	IO1350
		15.00	4.10	IO1550

Radiographic Template One™ | ASD0614

# Drill Sequence

Recommended drilling speed up to 1200 rpm

Implant Diameter:  $\varnothing 3.0$

$\varnothing 3.3$

$\varnothing 3.6$

$\varnothing 4.2$

$\varnothing 5.0$

hard bone

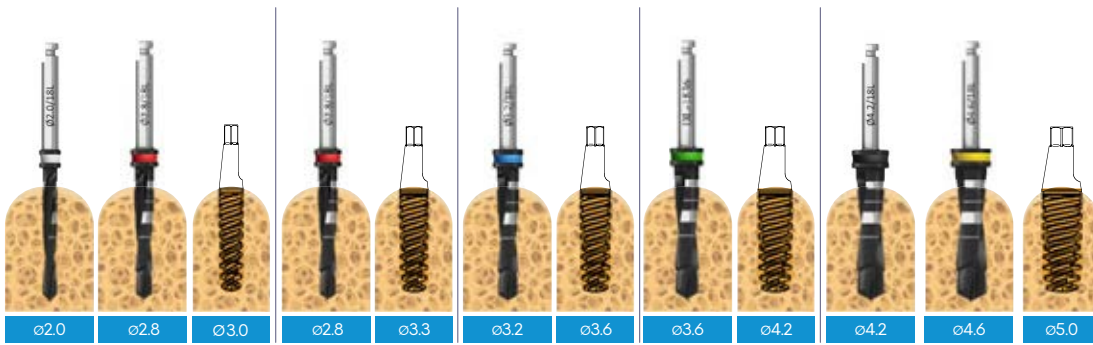

Implant Diameter:  $\varnothing 3.0$

$\varnothing 3.3$

$\varnothing 3.6$

$\varnothing 4.2$

$\varnothing 5.0$

soft bone

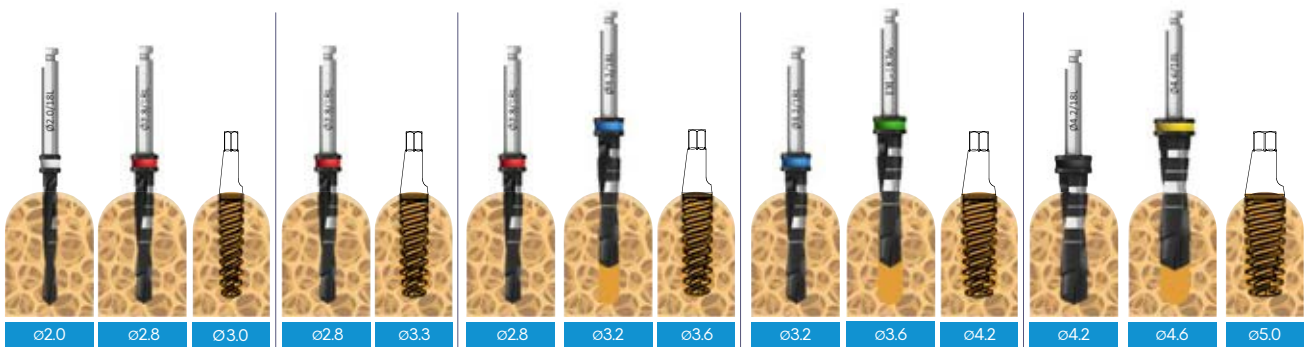







# Prosthetic Kit PK6300

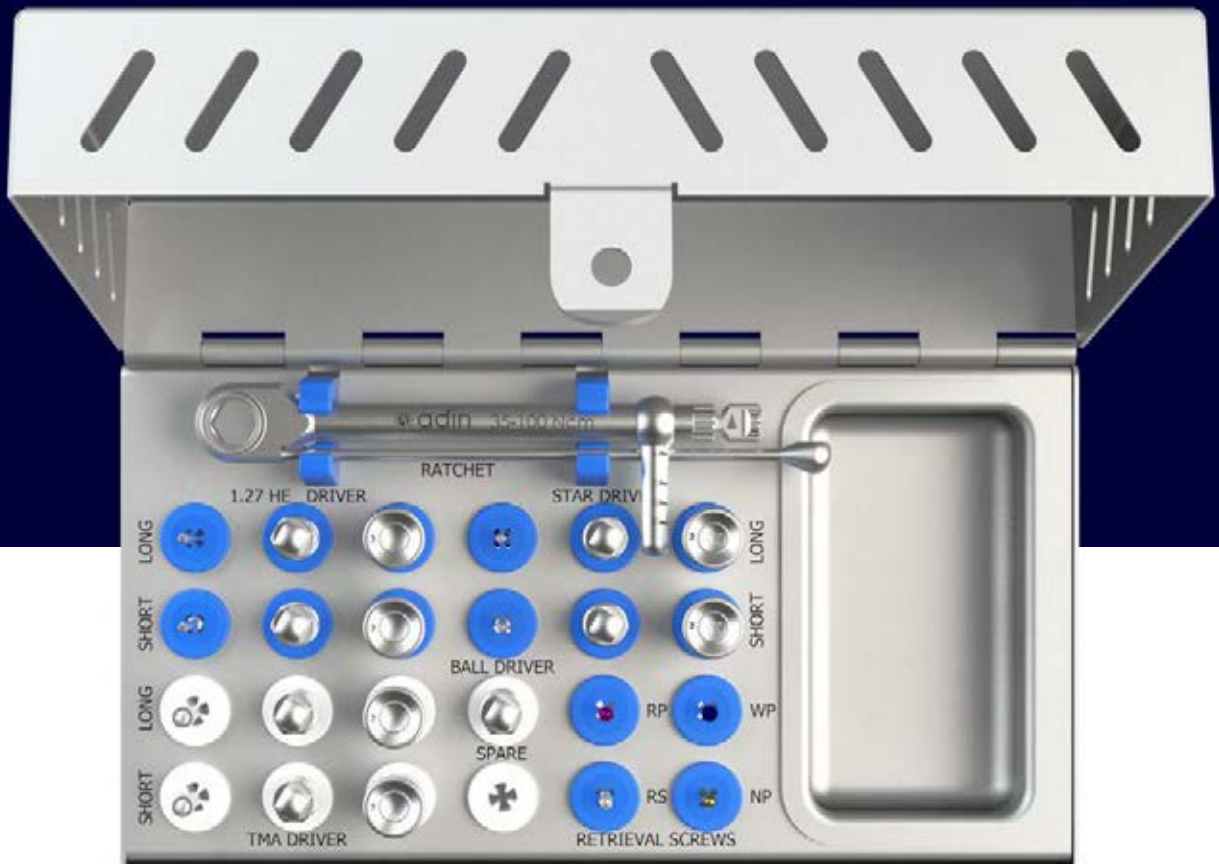

Prosthetic Kit		L	Catalog No.
	1.27 Hex Driver for Handpiece-Long	30.0	RS9035
	1.27 Hex Driver for Handpiece-Short	25.0	RS9030
	TMA/FC Hex Handpiece Adapter-Long	25.0	RS6195A
	TMA/FC Hex Handpiece Adapter-Short	20.0	RS6194
	1.27 Hex Torque Driver-Long	25.4	RS6082
	1.27 Hex Torque Driver-Short	20.4	RS6080
	TMA/FC Hex Torque Driver - Long	25.0	RS6196
	TMA/FC Hex Torque Driver - Short	20.0	RS6197
	1.27 Hex Hand Driver-Medium	28.4	RS6094
	1.27 Hex Hand Driver-Short	22.4	RS6095
	TMA/FC Female Hand Hex Driver-Short	22.4	RS6193
	TMA/FC Female Hand Hex Driver-Long	28.4	RS6191
	Star Handpiece Driver - Long	30.0	RP0019
	Star Handpiece Driver - Short	25.0	RP0018
	Torque Driver for Ball Attachment	14.4	RS6090
	Star Torque Driver - Long	25.4	RP0005
	Star Torque Driver-Short	20.4	RP0065
	RP Retrieval Screw for Abutments	12.2	RP3401
	RS Retrieval Screw For Abutments	15.0	RS3401
	Star Hand Driver - Long	28.4	RP0004
	Star Hand Driver-Short	23.4	RP0064
	WP Retrieval Screw for Abutments	12.3	WP3401
	NP Retrieval Screw for Abutments	13.4	NP0014
	Prosthetic Torque Ratchet 15-35 Ncm	98.0	RS6112







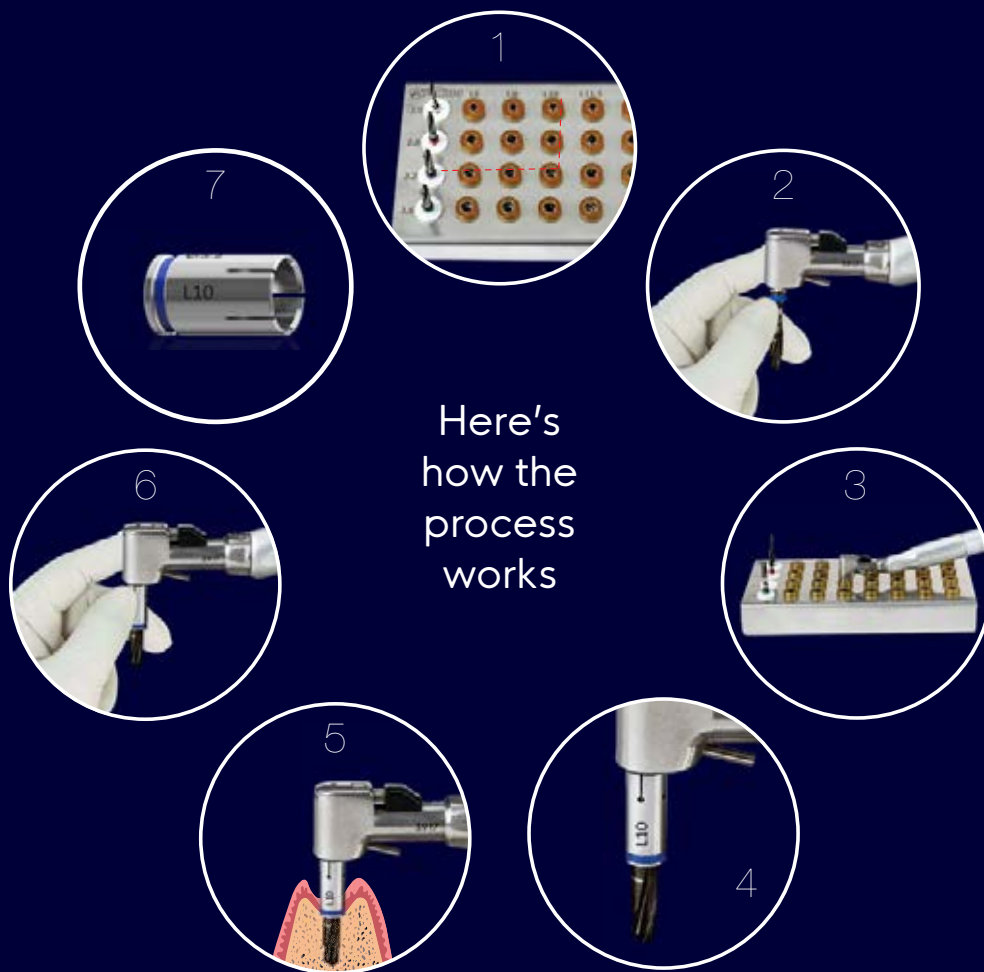

Each Drill Stops is marked with width and length,  
note that some are suitable for long and short drill according to the following:  
L: Drill length for long drill (18 mm)  
S: Drill length for short drill (13 mm)



# Drill Stop Kit S1001 | Regular Long



## Drills



Catalog No. DL1820	L
Pilot Drill 2mmD x 8-18mmL	35.5



Catalog No. DL1828	L
Twist Step Drill 2.3/2.8mmD x 8-18mmL	35.5



Catalog No. DL1832	L
Twist Step Drill 2.8/3.2mmD x 8-18mmL	35.5



Catalog No. DL1836	L
Twist Step Drill 3.2/3.6mmD x 8-18mmL	35.5

## Stoppers

## L

## Catalog No.

Stoppers	L	Catalog No.
Drill Stopper for Long L6 1820	6.0	S1820L6
Drill Stopper for Long L8 1820	8.0	S1820L8
Drill Stopper for Long L10 1820	10.0	S1820L10
Drill Stopper for Long L11.5 1820	11.5	S1820L11.5
Drill Stopper for Long L13/Short L8 1820	13.0	S1820L13
Drill Stopper for Long L15/Short L10 1820	15.0	S1820L15
Drill Stopper for Long L16 1820	16.0	S1820L16
Drill Stopper for Long L6 1828	6.0	S1828L6
Drill Stopper for Long L8 1828	8.0	S1828L8
Drill Stopper for Long L10 1828	10.0	S1828L10
Drill Stopper for Long L11.5 1828	11.5	S1828L11.5
Drill Stopper for Long L13/Short L8 1828	13.0	S1828L13
Drill Stopper for Long L15/Short L10 1828	15.0	S1828L15
Drill Stopper for Long L16 1828	16.0	S1828L16
Drill Stopper for Long L6 1832	6.0	S1832L6
Drill Stopper for Long L8 1832	8.0	S1832L8
Drill Stopper for Long L10 1832	10.0	S1832L10
Drill Stopper for Long L11.5 1832	11.5	S1832L11.5
Drill Stopper for Long L13/Short L8 1832	13.0	S1832L13
Drill Stopper for Long L15/Short L10 1832	15.0	S1832L15
Drill Stopper for Long L16 1832	16.0	S1832L16
Drill Stopper for Long L6 1836	6.0	S1836L6
Drill Stopper for Long L8 1836	8.0	S1836L8
Drill Stopper for Long L10 1836	10.0	S1836L10
Drill Stopper for Long L11.5 1836	11.5	S1836L11.5
Drill Stopper for Long L13/Short L8 1836	13.0	S1836L13
Drill Stopper for Long L15/Short L10 1836	15.0	S1836L15
Drill Stopper for Long L16 1836	16.0	S1836L16

# Drill Stop Kit S1002 | Wide Long



## Drills



Catalog No. DL1842

L

Twist Step Drill 3.8/4.2mmD x 8-18mmL

35.5



Catalog No. DL1846

L

Twist Step Drill 4.2/4.6mmD x 8-18mmL

35.5



Catalog No. DL1852

L

Twist Step Drill 4.8/5.2mmD x 8-18mmL

35.5



Catalog No. DL1856

L

Twist Step Drill 5.2/5.6mmD x 8-18mmL

35.5

## Stoppers

L

Catalog No.

Drill Stopper for Long L6 1842	6.0	S1842L6
Drill Stopper for Long L8 1842	8.0	S1842L8
Drill Stopper for Long L10 1842	10.0	S1842L10
Drill Stopper for Long L11.5 1842	11.5	S1842L11.5
Drill Stopper for Long L13/Short L8 1842	13.0	S1842L13
Drill Stopper for Long L15/Short L10 1842	15.0	S1842L15
Drill Stopper for Long L16 1842	16.0	S1842L16
Drill Stopper for Long L6 1846	6.0	S1846L6
Drill Stopper for Long L8 1846	8.0	S1846L8
Drill Stopper for Long L10 1846	10.0	S1846L10
Drill Stopper for Long L11.5 1846	11.5	S1846L11.5
Drill Stopper for Long L13/Short L8 1846	13.0	S1846L13
Drill Stopper for Long L15/Short L10 1846	15.0	S1846L15
Drill Stopper for Long L16 1846	16.0	S1846L16
Drill Stopper for Long L6 1852	6.0	S1852L6
Drill Stopper for Long L8 1852	8.0	S1852L8
Drill Stopper for Long L10 1852	10.0	S1852L10
Drill Stopper for Long L11.5 1852	11.5	S1852L11.5
Drill Stopper for Long L13/Short L8 1852	13.0	S1852L13
Drill Stopper for Long L15/Short L10 1852	15.0	S1852L15
Drill Stopper for Long L16 1852	16.0	S1852L16
Drill Stopper for Long L6 1856	6.0	S1856L6
Drill Stopper for Long L8 1856	8.0	S1856L8
Drill Stopper for Long L10 1856	10.0	S1856L10
Drill Stopper for Long L11.5 1856	11.5	S1856L11.5
Drill Stopper for Long L13/Short L8 1856	13.0	S1856L13
Drill Stopper for Long L15/Short L10 1856	15.0	S1856L15
Drill Stopper for Long L16 1856	16.0	S1856L16

# Drill Stop Kit

## S1003 | Regular Short



### Drills



Catalog No. DL1320	L
Pilot Drill 2mmD x 6-13mmL	30.5



Catalog No. DL1328	L
Twist Step Drill 2.3/2.8mmD x 6-13mmL	30.5



Catalog No. DL1332	L
Twist Step Drill 2.8/3.2mmD x 6-13mmL	30.5



Catalog No. DL1336	L
Twist Step Drill 3.2/3.6mmD x 6-13mmL	30.5

### Stoppers

	L	Catalog No.
Drill Stopper for Short L6 1320	6.0	S1320L6
Drill Stopper for Short L11.5 1320	11.5	S1320L11.5
Drill Stopper for Short L6 1328	6.0	S1328L6
Drill Stopper for Short L11.5 1328	11.5	S1328L11.5
Drill Stopper for Short L6 1332	6.0	S1332L6
Drill Stopper for Short L11.5 1332	11.5	S1332L11.5
Drill Stopper for Short L6 1336	6.0	S1336L6
Drill Stopper for Short L11.5 1336	11.5	S1336L11.5
Drill Stopper for Long L13/Short L8 1820	13.0	S1820L13
Drill Stopper for Long L15/Short L10 1820	15.0	S1820L15
Drill Stopper for Long L13/Short L8 1828	13.0	S1828L13
Drill Stopper for Long L15/Short L10 1828	15.0	S1828L15
Drill Stopper for Long L13/Short L8 1832	13.0	S1832L13
Drill Stopper for Long L15/Short L10 1832	15.0	S1832L15
Drill Stopper for Long L13/Short L8 1836	13.0	S1836L13
Drill Stopper for Long L15/Short L10 1836	15.0	S1836L15

# Drill Stop Kit S1004 | Wide Short



## Drills



Catalog No. DL1342 L

Twist Step Drill 3.8/4.2mmD x 6-13mmL 30.5



Catalog No. DL1346 L

Twist Step Drill 4.2/4.6mmD x 6-13mmL 30.5



Catalog No. DL1352 L

Twist Step Drill 4.8/5.2mmD x 6-13mmL 30.5



Catalog No. DL1356 L

Twist Step Drill 5.2/5.6mmD x 6-13mmL 30.5

Stoppers	L	Catalog No.
Drill Stopper for Short L6 1342	6.0	S1342L6
Drill Stopper for Short L11.5 1342	11.5	S1342L11.5
Drill Stopper for Short L6 1346	6.0	S1346L6
Drill Stopper for Short L11.5 1346	11.5	S1346L11.5
Drill Stopper for Short L6 1352	6.0	S1352L6
Drill Stopper for Short L11.5 1352	11.5	S1352L11.5
Drill Stopper for Short L6 1356	6.0	S1356L6
Drill Stopper for Short L11.5 1356	11.5	S1356L11.5
Drill Stopper for Long L13/Short L8 1842	13.0	S1842L13
Drill Stopper for Long L15/Short L10 1842	15.0	S1842L15
Drill Stopper for Long L13/Short L8 1846	13.0	S1846L13
Drill Stopper for Long L15/Short L10 1846	15.0	S1846L15
Drill Stopper for Long L13/Short L8 1852	13.0	S1852L13
Drill Stopper for Long L15/Short L10 1852	15.0	S1852L15
Drill Stopper for Long L13/Short L8 1856	13.0	S1856L13
Drill Stopper for Long L15/Short L10 1856	15.0	S1856L15



# Index in Alphabetical Order

Description	Catalog No.	Page No.	Description	Catalog No.	Page No.
1.27 Hex Driver for Handpiece - Long	RS9035	38, 161	Drill S-5.5, 3.2/2.5mmDx11.5mml	GS1132	49, 129
1.27 Hex Driver for Handpiece - Short	RS9030	38, 161	Drill S-5.5, 3.2/2.5mmDx13.0mml	GS1332	49, 129
1.27 Hex Hand Driver-Long	RS6097	38	Drill S-5.5, 3.2/2.5mmDx16.0mml	GS1632	49, 129
1.27 Hex Hand Driver-Medium	RS6094	38, 42, 43, 44, 45, 59, 143, 161	Drill S-5.5, 3.2/2.5mmDx18.0mml	GS1832	53, 135
1.27 Hex Hand Driver-Short	RS6095	38, 42, 43, 44, 45, 59, 143, 161	Drill S-5.5, 3.2/2.5mmDx6.25mml	GS0632	49, 129
1.27 Hex Torque Driver-Long	RS6082	37, 161	Drill S-5.5, 3.2/2.5mmDx8.0mml	GS0832	49, 129
1.27 Hex Torque Driver-Short	RS6080	37, 161	Drill S-5.5, 3.85/3.2mmDx10.0mml	GS1038	49, 129
			Drill S-5.5, 3.85/3.2mmDx11.5mml	GS1138	49, 129
<b>A</b>			Drill S-5.5, 3.85/3.2mmDx13.0mml	GS1338	49, 129
Anchoring Drill S-2.0, 2.0/1.5mmDx19mml	GS1915	51, 131, 133	Drill S-5.5, 3.85/3.2mmDx16.0mml	GS1638	49, 129
Anchoring Drill S-2.0, 2.0/1.7mmDx19mml	GS1917	51, 131, 133	Drill S-5.5, 3.85/3.2mmDx6.25mml	GS0638	49, 129
Anchorage Screw 2.0D 19mml	GS1920	52, 134	Drill S-5.5, 3.85/3.2mmDx8.0mml	GS0838	49, 129
			Drill S-5.5, 4.6/3.85mmDx10.0mml	GS1046	49, 129
<b>B</b>			Drill S-5.5, 4.6/3.85mmDx11.5mml	GS1146	49, 129
Ball Attachment Abutment Replica	RS5740	27, 75, 84, 97, 109	Drill S-5.5, 4.6/3.85mmDx13.0mml	GS1346	49, 129
			Drill S-5.5, 4.6/3.85mmDx16.0mml	GS1646	49, 129
<b>C</b>			Drill S-5.5, 4.6/3.85mmDx6.25mml	GS0646	49, 129
CloseFit™ NP Dental Implant 3.0D 10L	ISPNP1030	68	Drill S-5.5, 4.6/3.85mmDx8.0mml	GS0846	49, 129
CloseFit™ NP Dental Implant 3.0D 11.5L	ISPNP1130	68	Drill Stopper for Long L10 1820	S1820L10	165
CloseFit™ NP Dental Implant 3.0D 13L	ISPNP1330	68	Drill Stopper for Long L10 1828	S1828L10	165
CloseFit™ NP Dental Implant 3.0D 16L	ISPNP1630	68	Drill Stopper for Long L10 1832	S1832L10	165
CloseFit™ NP Dental Implant 3.0D 18L	ISPNP1830	68	Drill Stopper for Long L10 1836	S1836L10	165
CloseFit™ Plastic Surgical Kit-Advanced	CF6302	122, 124	Drill Stopper for Long L10 1842	S1842L10	166
CloseFit™ Plastic Surgical Kit-Advanced Short Drills	CF6304	124	Drill Stopper for Long L10 1846	S1846L10	166
CloseFit™ Plastic Surgical Kit-Premium	CF6300	122, 123	Drill Stopper for Long L10 1852	S1852L10	166
CloseFit™ Plastic Surgical Kit-Starter	CF6303	122, 125	Drill Stopper for Long L10 1856	S1856L10	166
CloseFit™ RP Dental Implant 3.5D 10L	ISPX1035	90	Drill Stopper for Long L11.5 1820	S1820L11.5	165
CloseFit™ RP Dental Implant 3.5D 11.5L	ISPX1135	90	Drill Stopper for Long L11.5 1828	S1828L11.5	165
CloseFit™ RP Dental Implant 3.5D 13L	ISPX1335	90	Drill Stopper for Long L11.5 1832	S1832L11.5	165
CloseFit™ RP Dental Implant 3.5D 15L	ISPX1535	90	Drill Stopper for Long L11.5 1836	S1836L11.5	165
CloseFit™ RP Dental Implant 3.5D 18L	ISPX1835	90	Drill Stopper for Long L11.5 1842	S1842L11.5	166
CloseFit™ RP Dental Implant 3.5D 8.0L	ISPX0835	90	Drill Stopper for Long L11.5 1846	S1846L11.5	166
CloseFit™ UNP Dental Implant 2.75D 10L	ISPUNP1027	80	Drill Stopper for Long L11.5 1852	S1852L11.5	166
CloseFit™ UNP Dental Implant 2.75D 11.5L	ISPUNP1127	80	Drill Stopper for Long L11.5 1856	S1856L11.5	166
CloseFit™ UNP Dental Implant 2.75D 13L	ISPUNP1327	80	Drill Stopper for Long L13/Short L8 1820	S1820L13	165
CloseFit™ UNP Dental Implant 2.75D 16L	ISPUNP1627	80	Drill Stopper for Long L13/Short L8 1828	S1828L13	165, 167, 168
CloseFit™ UNP Dental Implant 2.75D 18L	ISPUNP1827	80	Drill Stopper for Long L13/Short L8 1832	S1832L13	165, 167, 168
CloseFit™ WP Dental Implant 4.3D 10L	ISPX1043	102	Drill Stopper for Long L13/Short L8 1836	S1836L13	165, 167, 168
CloseFit™ WP Dental Implant 4.3D 11.5L	ISPX1143	102	Drill Stopper for Long L13/Short L8 1842	S1842L13	166
CloseFit™ WP Dental Implant 4.3D 13L	ISPX1343	102	Drill Stopper for Long L13/Short L8 1846	S1846L13	166
CloseFit™ WP Dental Implant 4.3D 15L	ISPX1543	102	Drill Stopper for Long L13/Short L8 1852	S1852L13	166
CloseFit™ WP Dental Implant 4.3D 18L	ISPX1843	102	Drill Stopper for Long L13/Short L8 1856	S1856L13	166
CloseFit™ WP Dental Implant 4.3D 8.0L	ISPX0843	102	Drill Stopper for Long L15/Short L10 1820	S1820L15	165
CloseFit™ WP Dental Implant 5D 10L	ISPX1049	102	Drill Stopper for Long L15/Short L10 1828	S1828L15	165, 167, 168
CloseFit™ WP Dental Implant 5D 11.5L	ISPX1149	102	Drill Stopper for Long L15/Short L10 1832	S1832L15	165, 168
CloseFit™ WP Dental Implant 5D 13L	ISPX1349	102	Drill Stopper for Long L15/Short L10 1836	S1836L15	165, 167, 168
CloseFit™ WP Dental Implant 5D 15L	ISPX1549	102	Drill Stopper for Long L15/Short L10 1842	S1842L15	166
CloseFit™ WP Dental Implant 5D 18L	ISPX1849	102	Drill Stopper for Long L15/Short L10 1846	S1846L15	166
CloseFit™ WP Dental Implant 5D 8.0L	ISPX0849	102	Drill Stopper for Long L15/Short L10 1852	S1852L15	166
			Drill Stopper for Long L15/Short L10 1856	S1856L15	166
<b>D</b>			Drill Stopper for Long L16 1820	S1820L16	165
Depth Probe	RS6180	35, 42, 43, 44, 117, 122, 123, 124	Drill Stopper for Long L16 1828	S1828L16	165
Drill Extension	RS9027	36, 42, 43, 44, 122, 123, 124, 131, 133	Drill Stopper for Long L16 1832	S1832L16	165
Drill S-3.3, 2.5/1.8mmDx10.0mml	GSN1025	131	Drill Stopper for Long L16 1836	S1836L16	165
Drill S-3.3, 2.5/1.8mmDx11.5mml	GSN1125	131	Drill Stopper for Long L16 1842	S1842L16	166
Drill S-3.3, 2.5/1.8mmDx13.0mml	GSN1325	131	Drill Stopper for Long L16 1846	S1846L16	166
Drill S-3.3, 2.5/1.8mmDx16.0mml	GSN1625	131	Drill Stopper for Long L16 1852	S1852L16	166
Drill S-3.3, 2.5/1.8mmDx18.0mml	GSN1825	53, 135	Drill Stopper for Long L16 1856	S1856L16	166
Drill S-5.5, 2.5/1.8mmDx10.0mml	GS1025	49, 129	Drill Stopper for Long L6 1820	S1820L6	165
Drill S-5.5, 2.5/1.8mmDx11.5mml	GS1125	49, 129	Drill Stopper for Long L6 1828	S1828L6	165
Drill S-5.5, 2.5/1.8mmDx13.0mml	GS1325	49, 129	Drill Stopper for Long L6 1836	S1836L6	165
Drill S-5.5, 2.5/1.8mmDx16.0mml	GS1625	49, 129	Drill Stopper for Long L6 1842	S1842L6	166
Drill S-5.5, 2.5/1.8mmDx18.0mml	GS1825	53, 135	Drill Stopper for Long L6 1846	S1846L6	166
Drill S-5.5, 2.5/1.8mmDx8.0mml	GS0825	49, 129	Drill Stopper for Long L6 1852	S1852L6	166
Drill S-5.5, 3.2/2.5mmDx10.0mml	GS1032	49, 129	Drill Stopper for Long L6 1856	S1856L6	166

Description	Catalog No.	Page No.	Description	Catalog No.	Page No.
Drill Stopper for Long L8 1820	S1820L8	165	NP Ball Attachment 0.5mm	NP0020	75
Drill Stopper for Long L8 1828	S1828L8	165	NP Ball Attachment 1mm	NP0021	75
Drill Stopper for Long L8 1836	S1836L8	165	NP Ball Attachment 2mm	NP0022	75
Drill Stopper for Long L8 1842	S1842L8	166	NP Ball Attachment 3mm	NP0023	75
Drill Stopper for Long L8 1846	S1846L8	166	NP Ball Attachment 4mm	NP0024	75
Drill Stopper for Long L8 1852	S1852L8	166	NP CloseFit™ Angled Abutment 15° - No End Line	NP0018	72
Drill Stopper for Long L8 1856	S1856L8	166	NP CloseFit™ Angled Abutment 15° 1mm	NP0015	72
Drill Stopper for Long L6 1832	S1832L6	165	NP CloseFit™ Angled Abutment 15° 2mm	NP0026	72
Drill Stopper for Long L8 1832	S1832L8	165	NP CloseFit™ Angled Abutment 15° 3mm	NP0063	72
Drill Stopper for Short L11.5 1320	S1320L11.5	167, 168	NP CloseFit™ Angled Abutment 25° - No End Line	NP0025	72
Drill Stopper for Short L11.5 1328	S1328L11.5	167, 168	NP CloseFit™ Close Tray Transfer 4.2mmDx13mmL	NP5213	71
Drill Stopper for Short L11.5 1332	S1332L11.5	167, 168	NP CloseFit™ Close Tray Transfer Screw	NP5127	77
Drill Stopper for Short L6 1320	S1320L6	167, 168	NP CloseFit™ Open Tray Transfer 4.2mmDx14mmL	NP5514	71
Drill Stopper for Short L6 1328	S1328L6	167, 168	NP CloseFit™ Open Tray Transfer Screw	NP5014	77
Drill Stopper for Short L6 1332	S1332L6	167, 168	NP CloseFit™ Scan Body 10mm	NP0089	71, 139
Drill Stopper for Short L6 1336	S1336L6	167, 168	NP CloseFit™ Scan Body 7mm	NP0088	71, 139
Drill S-5.5, 3.85/3.2mmDx18.0mmL	GS1838	53, 135	NP CloseFit™ Slim Close Tray Transfer 3.2mmDx13mmL	NP5113	71
Drill S-5.5, 4.6/3.85mmDx18.0mmL	GS1846	53, 135	NP CloseFit™ Slim Open Tray Transfer 3.2mmDx14mmL	NP5614	71
<b>E</b>			NP CloseFit™ Ti Base Angular Engaged	NP1017	139
Extraction Tool Spanner	GS0036	51	NP CloseFit™ Ti Base Engaged	NP1004	139
<b>F</b>			NP CloseFit™ Ti Base Non Engaged	NP1008	139
Flat Connection Abutment 2mm	FC4502	31	NP CloseFit™ Ti Pre Milled MDTK Abutment Blank ø11.5mm	NP1111	139
Flat Connection Abutment 4mm	FC4504	31, 76, 98, 110	NP CloseFit™ Ti Pre Milled MDTK Abutment Blank ø15.8mm	NP1115	139
Flat Connection Castable Abutment for Centering Ring	FC6011	31, 76, 98, 110	NP Conical Healing Abutment 4.5mmD x 2mmL	NP0090	69
Flat Connection Centering Ring	FC6018	31, 76, 98, 110	NP Conical Healing Abutment 4.5mmD x 3mmL	NP0091	69
Flat Connection Implant Replica	FC5737	31, 76, 98, 110	NP Conical Healing Abutment 4.5mmD x 4mmL	NP0092	69
Flat Connection Long Laboratory Screw	FC6017	31, 76, 98, 110	NP Conical Healing Abutment 4.5mmD x 5mmL	NP0093	69
Flat Connection Temporary Cylinder Sleeve	FC5515	31, 76, 98, 110	NP Conical Healing Abutment 4.5mmD x 6mmL	NP0094	69
Flat Connection Titanium Gluing Ring	FC6013	31, 76, 98, 110	NP Conical Implant Cover Screw	NP0073	69
Flat Connection Titanium Retaining Screw	FC6015	31, 76, 98, 110	NP Digital Model Analog	NP1000	71, 143
Flat Connection Transfer Impression Coping	FC5512	31, 76, 98, 110	NP Engaging Temporary Abutment	NP0043	72
<b>G</b>			NP Engaging Titanium/Plastic Abutment	NP3095	72
Guide Fixation Screw Driver	GS0027	51, 131, 133	NP Flat Connection Abutment 2mm	NP0030	76
Guided Surgery Accessories KIT - RS Implants	GSK003	50-51	NP Flat Connection Abutment 4mm	NP0031	76
Guided Surgery Drills KIT - Basic	GSK001	48-49	NP Healing Abutment 4.5mmD x 2mmL	NP0004	69
<b>H</b>			NP Healing Abutment 4.5mmD x 3mmL	NP0008	69
Handpiece Guide Fixation Screw Driver	GS0028	51, 131, 133	NP Healing Abutment 4.5mmD x 4mmL	NP0009	69
Handpiece Socket L10.5	GS0021	51, 131, 133	NP Healing Abutment 4.5mmD x 5mmL	NP0012	69
Handpiece Socket L14.5	GS0022	51	NP Healing Abutment 4.5mmD x 6mmL	NP0013	69
<b>M</b>			NP Implant Analog	NP0007	71
Manual Socket L10.5	GS0023	51, 131, 133	NP Non Engaging Temporary Abutment	NP0044	72
Manual Socket L14.5	GS0024	51, 131, 133	NP Non-Engaging Titanium/Plastic Abutment	NP3097	72
<b>N</b>			NP Plastic Cylinder Abutment	NP0045	72
Narrow Implants 3.3mmD Sleeve	GS0033	130, 134	NP Retaining Screw for Angled TMA	NP0042	77
Narrow Tissue Punch 3.0mmD, S-3.3	GSN3033	131	NP Retaining Screw for TMA 1mm	NP0039	77
NP 2mm Hex Handpiece Adapter - Long	NP0072	79	NP Retaining Screw for TMA 2mm	NP0040	77
NP 2mm Hex Handpiece Adapter - Long	NP0074	79, 122, 123, 124, 125	NP Retaining Screw for TMA 3mm	NP0041	77
NP 2mm Hex Handpiece Adapter - Medium	NP0071	79, 122, 123, 124, 125	NP Retaining Screw for TMA 4mm	NP3409	77
NP 2mm Hex Handpiece Adapter - Short	NP0062	79	NP Retaining Screw for TMA 5mm	NP3412	77
NP 2mm Hex Handpiece Adapter - Short	NP0068	79, 122, 123, 124, 125	NP Retrieval Screw for Abutments	NP0014	85, 77, 161
NP 2mm Hex Torque Driver - Long	NP0005	78	NP Slim Healing Abutment 3mmD x 2mmL	NP0046	69
NP 2mm Hex Torque Driver - Short	NP0006	78	NP Slim Healing Abutment 3mmD x 3mmL	NP0047	69
NP Abutment Screw	NP0001	77, 85, 139, 144	NP Slim Healing Abutment 3mmD x 4mmL	NP0048	69
NP Angled Trans Mucosal Abutment 17° L=3mm	NP0035	73	NP Slim Healing Abutment 3mmD x 5mmL	NP0049	69
NP Angled Trans Mucosal Abutment 17° L=4mm	NP0038	73	NP Slim Healing Abutment 3mmD x 6mmL	NP0050	69
NP Angled Trans Mucosal Abutment 30° L=3.5mm	NP0036	73	NP Straight Abutment 1mm	NP0019	72
NP Angled Trans Mucosal Abutment 30° L=5mm	NP0037	73	NP Straight Abutment 2mm	NP0011	72
			NP Straight Abutment 3mm	NP0064	72
			NP Straight Slim Abutment - No End Line	NP0010	72
			NP Straight Trans Mucosal Abutment 1mm	NP0032	73



Description	Catalog No.	Page No.	Description	Catalog No.	Page No.
NP Straight Trans Mucosal Abutment 2mm	NP0033	73	RP CloseFit™ Close Tray Transfer 4.2mmDx9mmL	RP5209	93
NP Straight Trans Mucosal Abutment 3mm	NP0034	73	RP CloseFit™ Close Tray Transfer Screw Long	RP5127	99
NP Straight Trans Mucosal Abutment 4mm	NP3729	73	RP CloseFit™ Close Tray Transfer Screw Short	RP5126	99
NP Straight Trans Mucosal Abutment 5mm	NP3730	73	RP CloseFit™ Open Tray Transfer 4.2mmDx10mmL	RP5510	93
<b>O</b>			RP CloseFit™ Open Tray Transfer 4.2mmDx14mmL	RP5514	93
One™ Dental Implant 3.0D 10L	IO1030	18	RP CloseFit™ Open Tray Transfer Screw Long	RP5014	99
One™ Dental Implant 3.0D 11.5L	IO1130	18	RP CloseFit™ Open Tray Transfer Screw Short	RP5010	99
One™ Dental Implant 3.0D 13L	IO1330	18	RP CloseFit™ Scan Body 10mm	RP0089	93, 141
One™ Dental Implant 3.0D 15L	IO1530	18	RP CloseFit™ Scan Body 7mm	RP0088	93, 141
One™ Dental Implant 3.3D 10L	IO1033	18	RP CloseFit™ Slim Close Tray Transfer 3.6mmDx13mmL	RP5113	93
One™ Dental Implant 3.3D 11.5L	IO1133	18	RP CloseFit™ Slim Close Tray Transfer 3.6mmDx9mmL	RP5109	93
One™ Dental Implant 3.3D 13L	IO1333	18	RP CloseFit™ Slim Open Tray Transfer 3.6mmDx10mmL	RP5610	93
One™ Dental Implant 3.3D 15L	IO1533	18	RP CloseFit™ Slim Open Tray Transfer 3.6mmDx14mmL	RP5614	93
One™ Dental Implant 3.6D 10L	IO1036	18	RP CloseFit™ Ti Base Angular Engaged	RP1217	141
One™ Dental Implant 3.6D 11.5L	IO1136	18	RP CloseFit™ Ti Base Engaged	RP1204	141
One™ Dental Implant 3.6D 13L	IO1336	18	RP CloseFit™ Ti Base Non Engaged	RP1208	141
One™ Dental Implant 3.6D 15L	IO1536	18	RP CloseFit™ Ti Pre Milled MDTK Abutment Blank ø11.5mm	RP1211	141
One™ Dental Implant 4.2D 10L	IO1042	18	RP CloseFit™ Ti Pre Milled MDTK Abutment Blank ø15.8mm	RP1215	141
One™ Dental Implant 4.2D 11.5L	IO1142	18	RP Conical Healing Abutment 4.5mmD x 2mmL	RP0090	91
One™ Dental Implant 4.2D 13L	IO1342	18	RP Conical Healing Abutment 4.5mmD x 3mmL	RP0091	91
One™ Dental Implant 4.2D 15L	IO1542	18	RP Conical Healing Abutment 4.5mmD x 4mmL	RP0092	91
One™ Dental Implant 5.0D 10L	IO1050	18	RP Conical Healing Abutment 4.5mmD x 5mmL	RP0093	91
One™ Dental Implant 5.0D 11.5L	IO1150	18	RP Conical Healing Abutment 4.5mmD x 6mmL	RP0094	91
One™ Dental Implant 5.0D 13L	IO1350	18	RP Conical Implant Cover Screw	RP0073	91
One™ Dental Implant 5.0D 15L	IO1550	18	RP Digital Model Analog	RP1000	93, 143
<b>P</b>			RP Engaging Temporary Abutment	RP0043	94
Parallel Pin 11	RS6150	36, 42, 43, 44, 118, 122, 123, 124	RP Engaging Titanium/Plastic Abutment	RP3095	94
Parallel Pin 16	RS6155	36, 42, 43, 44, 118, 122, 123, 124	RP Flat Connection Abutment 2mm	RP0030	98
Pilot Drill 2mmD x 6-13mmL	DL1320	34, 42, 43, 116, 122, 123, 167	RP Flat Connection Abutment 4mm	RP0031	98
Pilot Drill 2mmD x 8-18mmL	DL1820	34, 42, 43, 44, 45, 116, 122, 123, 124, 125, 165	RP Handpiece Hex Adapter-Long	RP0072	101
Pilot Drill S-3-3, 2.5/1.8mmDx6.0mmL	GSN0625	131	RP Handpiece Hex Adapter-Short	RP0062	101
Pilot Drill S-5-5, 2.5/1.8mmDx6.0mmL	GS0625	49, 129	RP Healing Abutment 4.5mmD x 2mmL	RP0022	91
Plastic Ball Cap Pink Soft	RS2662	27, 75, 84, 97, 109	RP Healing Abutment 4.5mmD x 3mmL	RP0023	91
Plastic Ball Cap White	RS2660	27, 75, 84, 97, 109	RP Healing Abutment 4.5mmD x 4mmL	RP0024	91
Prosthetic Kit Metal	PK6300	160-161	RP Healing Abutment 4.5mmD x 5mmL	RP0025	91
Prosthetic Torque Ratchet 15-35 Ncm	RS6112	37, 117, 161	RP Healing Abutment 4.5mmD x 6mmL	RP0026	91
<b>R</b>			RP Implant Analog	RP0007	93
Ratchet 4mm Hex	GS0010	51	RP Non-Engaging Temporary Abutment	RP0044	94
Regular Long Drill Stop Kit	S1001	165	RP Non-Engaging Titanium/Plastic Abutment	RP3097	94
Regular Short Drill Stop Kit	S1003	167	RP Plastic Cylinder Abutment	RP0045	94
Retaining Screw for Digital Model Analog	RS1002	59, 143	RP Retaining Screw for Angled TMA	RP3403	99
RP 2.25mm Hex Handpiece Adapter - Long	RP0074	101, 122, 123, 124, 125	RP Retaining Screw for TMA 1mm	RP0039	99
RP 2.25mm Hex Handpiece Adapter - Medium	RP0071	101, 122, 123, 124, 125	RP Retaining Screw for TMA 2mm	RP0040	99
RP 2.25mm Hex Handpiece Adapter - Short	RP0068	101, 122, 123, 124, 125	RP Retaining Screw for TMA 3mm	RP0041	99
RP 2.2mm Hex Torque Driver-Long	RP0066	100	RP Retaining Screw for TMA 4mm	RP3409	99
RP 2.2mm Hex Torque Driver-Short	RP0067	100	RP Retaining Screw for TMA 5mm	RP3412	99
RP Abutment Screw	RP0001	99, 141, 144	RP Retrieval Screw for Abutments	RP3401	99, 161
RP Angled Abutment 15° 1mm	RP0013	94	RP Slim Healing Abutment 3.5mmD x 2mmL	RP0046	91
RP Angled Abutment 15° 2mm	RP0014	94	RP Slim Healing Abutment 3.5mmD x 3mmL	RP0047	91
RP Angled Abutment 15° 3mm	RP0015	94	RP Slim Healing Abutment 3.5mmD x 4mmL	RP0048	91
RP Angled Trans Mucosal Abutment 17° 2.5mm	RP3734	95	RP Slim Healing Abutment 3.5mmD x 5mmL	RP0049	91
RP Angled Trans Mucosal Abutment 17° 3.5mm	RP3737	95	RP Slim Healing Abutment 3.5mmD x 6mmL	RP0050	91
RP Angled Trans Mucosal Abutment 30° 3mm	RP3735	95	RP Straight Abutment 1mm	RP0012	94
RP Angled Trans Mucosal Abutment 30° 4mm	RP3738	95	RP Straight Abutment 2mm	RP0011	94
RP Ball Attachment 0.5mm	RP0051	97	RP Straight Abutment 3mm	RP0010	94
RP Ball Attachment 1mm	RP0052	97	RP Straight Slim Abutment - No End Line	RP0020	94
RP Ball Attachment 2mm	RP0053	97	RP Straight Trans Mucosal Abutment 1mm	RP0032	95
RP Ball Attachment 3mm	RP0054	97	RP Straight Trans Mucosal Abutment 2mm	RP0033	95
RP Ball Attachment 4mm	RP0055	97	RP Straight Trans Mucosal Abutment 3mm	RP0034	95
RP Ball Attachment 5mm	RP0056	97	RP Straight Trans Mucosal Abutment 4mm	RP3729	95
RP CloseFit™ Close Tray Transfer 4.2mmDx13mmL	RP5213	93			

Description	Catalog No.	Page No.	Description	Catalog No.	Page No.
RP Straight Trans Mucosal Abutment 5 mm	RP3730	95	RS Open Tray Transfer 4.5mmDx14mmL	RS4514	23
RS 2.4 Hex Torque Driver-Long	RS6012	36	RS Open Tray Transfer Screw Long	RS3429	26
RS 2.4 Hex Torque Driver-Short	RS6011	36	RS Open Tray Transfer Screw Short	RS3428	26
RS Angled Titanium Abutment 15°	RS4015	25	RS Prosthetic Screw	RS3400	26, 56, 58
RS Angled Titanium Abutment 15° Long	RS4016	25	RS Retaining Screw For Angled TMA	RS3403	30
RS Angled Titanium Abutment 25°	RS4025	25	RS Retaining Screw for TMA 1mm	RS3406	30
RS Angled Titanium Abutment 35°	RS4035	25	RS Retaining Screw for TMA 2mm	RS3407	30
RS Angled Trans Mucosal Abutment 17° 2mm	RS3734	28	RS Retaining Screw for TMA 3mm	RS3408	30
RS Angled Trans Mucosal Abutment 17° 3mm	RS3737	28	RS Retaining Screw for TMA 4mm	RS3409	30
RS Angled Trans Mucosal Abutment 30° 3mm	RS3735	28	RS Retaining Screw for TMA 5mm	RS3412	30
RS Angled Trans Mucosal Abutment 30° 4mm	RS3738	28	RS Retrieval Screw For Abutments	RS3401	38, 161
RS Angled Trans Mucosal Abutment 45° 4mm	RS3736	28	RS Scan Body 10mm	RS0089	23, 56
RS Ball Attachment 0.5mm	RS2650	27	RS Scan Body 7mm	RS0088	23, 56
RS Ball Attachment 1mm	RS2651	27	RS Screw Fixture Mount	GS0029	51
RS Ball Attachment 1mm w/Hex	RS2861	27	RS Screw for Angled Titanium Abutment	RS3480	26
RS Ball Attachment 2mm	RS2652	27	RS Screw For Closed Tray Transfer	RS3425	56, 58
RS Ball Attachment 2mm w/Hex	RS2862	27	RS Short Prosthetic Screw	RS3402	26, 57, 58
RS Ball Attachment 3mm	RS2653	27	RS Slim Angled Abutment 15° 1mm - No End Line	RS4017	25
RS Ball Attachment 3mm w/Hex	RS2863	27	RS Slim Angled Abutment 15° 2mm - No End Line	RS4018	25
RS Ball Attachment 4mm	RS2654	27	RS Slim Angled Abutment 15° 3mm - No End Line	RS4019	25
RS Ball Attachment 4mm w/Hex	RS2864	27	RS Slim Close Tray Transfer 3.5mmDx13mmL	RS5113	23
RS Ball Attachment 5mm	RS2655	27	RS Slim Close Tray Transfer 3.5mmDx9mmL	RS5109	23
RS Ball Attachment 5mm w/Hex	RS2865	27	RS Slim Healing Abutment 3.5mmD x 2mmL	RS3027	20
RS Ball Attachment 6mm w/Hex	RS2866	27	RS Slim Healing Abutment 3.5mmD x 3mmL	RS3028	20
RS Close Tray Transfer 4.5mmDx13mmL	RS5213	23	RS Slim Healing Abutment 3.5mmD x 4mmL	RS3029	20
RS Close Tray Transfer 4.5mmDx9mmL	RS5209	23	RS Slim Healing Abutment 3.5mmD x 5mmL	RS3030	20
RS Digital Model Analog	RS1000	23, 59	RS Slim Healing Abutment 3.5mmD x 6mmL	RS3031	20
RS Engaging Cobalt Chrome/Plastic Abutment	RS3094	26	RS Slim Titanium Abutment 3mm	RS3903	25
RS Engaging Gold/Plastic Abutment	RS3090	26	RS Slim Titanium Abutment 6mm	RS3906	25
RS Engaging Plastic Casting Standard Abutment	RS5010	26	RS Slim Titanium Abutment 8mm	RS3908	25
RS Engaging Plastic Cylinder Abutment	RS5040	26	RS Straight Abutment 1mmL	RS0010	24
RS Engaging Plastic Cylinder Casting Abutment	RS5000	26	RS Straight Abutment 2mmL	RS0011	24
RS Engaging Plastic Standard Abutment	RS5030	26	RS Straight Abutment 3mmL	RS0012	24
RS Engaging Titanium/Plastic Abutment	RS3095	26	RS Straight Cylindrical Titanium Abutment 2mm	RS3411	25
RS Esthetic Angled Titanium Abutment 15° 1mm	RS4115	25	RS Straight Titanium Abutment - No End Line	RS3800	24
RS Esthetic Angled Titanium Abutment 15° 2mm	RS4117	25	RS Straight Titanium Abutment 1mm	RS3801	24
RS Esthetic Angled Titanium Abutment 15° 3mm	RS4119	25	RS Straight Titanium Abutment 2mm	RS3802	24
RS Extraction Tool	GS0035	51	RS Straight Titanium Abutment 3mm	RS3803	24
RS Handpiece Fixture Mount	GS0032	51	RS Straight Titanium Abutment 4mm	RS3804	24
RS Healing Abutment 4.5mmD x 2mmL	RS3022	20	RS Straight Titanium Abutment 5 mm	RS3805	24
RS Healing Abutment 4.5mmD x 3mmL	RS3023	20	RS Straight Titanium Abutment Long 12.5mm	RS3811	24
RS Healing Abutment 4.5mmD x 4mmL	RS3024	20	RS Straight Trans Mucosal Abutment 1mm	RS3731	28
RS Healing Abutment 4.5mmD x 5mmL	RS3025	20	RS Straight Trans Mucosal Abutment 2mm	RS3732	28
RS Healing Abutment 4.5mmD x 6mmL	RS3026	20	RS Straight Trans Mucosal Abutment 3mm	RS3733	28
RS Hex Handpiece Adapter - Long	RS9029	36, 42, 43, 44, 45	RS Straight Trans Mucosal Abutment 4 mm	RS3729	28
RS Hex Handpiece Adapter - Medium	RS9026	36, 42, 43, 44, 45	RS Straight Trans Mucosal Abutment 5 mm	RS3730	28
RS Hex Handpiece Adapter - Short	RS9021	36, 42, 43, 44, 45	RS Ti Base Angular Engaged	RS1417	57
RS Hex Handpiece Adapter-Long	RS9025	36	RS Ti Base Engaged	RS1404	57
RS Hex Handpiece Adapter-Short	RS9020	36	RS Ti Base Non Engaged	RS1408	57
RS Implant Cover Screw	RS3435	20	RS Ti Pre Milled MDTK Abutment Blank ø11.5mm	RS1411	57
RS Internal Hex Implant Analog	RS5737	23	RS Ti Pre Milled MDTK Abutment Blank ø15.8mm	RS1415	57
RS Non-Engaging Cobalt Chrome/Plastic Abutment	RS3100	26	RS Wide Healing Abutment 6mmD x 2mmL	RS3012	20
RS Non-Engaging Plastic Cylinder Casting Abutment	RS5020	26	RS Wide Healing Abutment 6mmD x 3mmL	RS3013	20
RS Non-Engaging Plastic Standard Abutment	RS5050	26	RS Wide Healing Abutment 6mmD x 4mmL	RS3014	20
RS Non-Engaging Straight Cylindrical Titanium Abutment 2mm	RS3422	25	RS Wide Healing Abutment 6mmD x 5mmL	RS3015	20
RS Non-Engaging Titanium/Plastic Abutment	RS3097	26	RS Wide Profile Titanium Abutment	RS3890	25
RS One Piece Screw-In Abutment	RS3812	25	RS-Standard Internal Hex Plastic Surgical Kit-Advanced	RS6322	42, 44
RS One Piece Torque Driver-Long	RS6026	155	RS-Standard Internal Hex Plastic Surgical Kit-Starter	RS6333	42, 45
RS One Piece Torque Driver-Short	RS6025	155	RS-Standard Internal Hex Plastic Surgical Kit-Premium	RS6301	42, 43
RS Open Tray Slim Transfer 3.6mmDx10mmL	RS3510	23			
RS Open Tray Slim Transfer 3.6mmDx14mmL	RS3514	23			
RS Open Tray Transfer 4.5mmDx10mmL	RS4510	23			

Description	Catalog No.	Page No.	Description	Catalog No.	Page No.
<b>S</b>			TMA/FC Female Hand Hex Driver-Short	RS6193	30, 38, 78, 100, 112, 161
Stainless Steel Ball Cap	RS2675SS	27, 75, 84, 97, 109	TMA/FC Hex Handpiece Adapter-Long	RS6195A	30, 38, 79, 101, 113, 161
Star Hand Driver - Long	RP0004	30, 38, 78, 86, 100, 112, 122, 123, 124, 125, 131, 133, 161	TMA/FC Hex Handpiece Adapter-Short	RS6194	30, 38, 79, 101, 113, 161
Star Hand Driver-Short	RP0064	30, 38, 78, 86, 100, 112, 122, 123, 124, 125, 161	TMA/FC Hex Torque Driver - Long	RS6196	30, 37, 78, 100, 112, 161
Star Handpiece Driver - Long	RP0019	79, 86, 101, 113, 161	TMA/FC Hex Torque Driver - Short	RS6197	30, 37, 78, 100, 112, 161
Star Handpiece Driver - Short	RP0018	79, 86, 101, 113, 161	Torque Driver for Ball Attachment	RS6090	27, 37, 78, 86, 100, 161
Star Torque Driver - Long	RP0005	30, 37, 78, 86, 100, 112, 161	Touareg™-OS Dental Implant 3.5D 10L	ISF1035	15
Star Torque Driver-Short	RP0065	30, 37, 78, 86, 100, 112, 161	Touareg™-OS Dental Implant 3.5D 11.5L	ISF1135	15
Surgical Driver	RS7001	35, 117	Touareg™-OS Dental Implant 3.5D 13L	ISF1335	15
Surgical Torque Ratchet 35-100 Ncm	RS6111	35, 42, 43, 44, 117, 122, 123, 124, 125	Touareg™-OS Dental Implant 3.5D 16L	ISF1635	15
Swell™ Dental Implant 3.3D 10L	ID1033	14	Touareg™-OS Dental Implant 3.5D 18L	ISF1835	15
Swell™ Dental Implant 3.3D 11.5L	ID1133	18	Touareg™-OS Dental Implant 3.5D 8L	ISF0835	15
Swell™ Dental Implant 3.3D 13L	ID1333	18	Touareg™-OS Dental Implant 3.75D 10L	ISF1038	15
Swell™ Dental Implant 3.3D 16L	ID1633	18	Touareg™-OS Dental Implant 3.75D 11.5L	ISF1138	15
Swell™ Dental Implant 3.3D 18L	ID1833	18	Touareg™-OS Dental Implant 3.75D 13L	ISF1338	15
Swell™ Dental Implant 3.75D 10L	ID1038	18	Touareg™-OS Dental Implant 3.75D 16L	ISF1638	15
Swell™ Dental Implant 3.75D 11.5L	ID1138	18	Touareg™-OS Dental Implant 3.75D 18L	ISF1838	15
Swell™ Dental Implant 3.75D 13L	ID1338	18	Touareg™-OS Dental Implant 3.75D 8L	ISF0838	15
Swell™ Dental Implant 3.75D 16L	ID1638	18	Touareg™-OS Dental Implant 4.2D 10L	ISF1042	15
Swell™ Dental Implant 3.75D 18L	ID1838	18	Touareg™-OS Dental Implant 4.2D 11.5L	ISF1142	15
Swell™ Dental Implant 3.75D 8L	ID0838	18	Touareg™-OS Dental Implant 4.2D 13L	ISF1342	15
Swell™ Dental Implant 4.2D 10L	ID1042	18	Touareg™-OS Dental Implant 4.2D 16L	ISF1642	15
Swell™ Dental Implant 4.2D 11.5L	ID1142	18	Touareg™-OS Dental Implant 4.2D 18L	ISF1842	15
Swell™ Dental Implant 4.2D 13L	ID1342	18	Touareg™-OS Dental Implant 4.2D 6.25L	ISF0642	15
Swell™ Dental Implant 4.2D 16L	ID1642	18	Touareg™-OS Dental Implant 4.2D 8L	ISF0842	15
Swell™ Dental Implant 4.2D 18L	ID1842	18	Touareg™-OS Dental Implant 5.0D 10L	ISF1050	15
Swell™ Dental Implant 4.2D 6.25L	ID0642	18	Touareg™-OS Dental Implant 5.0D 11.5L	ISF1150	15
Swell™ Dental Implant 4.2D 8L	ID0842	18	Touareg™-OS Dental Implant 5.0D 13L	ISF1350	15
Swell™ Dental Implant 5.0D 10L	ID1050	18	Touareg™-OS Dental Implant 5.0D 16L	ISF1650	15
Swell™ Dental Implant 5.0D 11.5L	ID1150	18	Touareg™-OS Dental Implant 5.0D 6.25L	ISF0650	15
Swell™ Dental Implant 5.0D 13L	ID1350	18	Touareg™-OS Dental Implant 5.0D 8L	ISF0850	15
Swell™ Dental Implant 5.0D 16L	ID1650	18	Touareg™-OS Dental Implant 6.0D 10L	ISF1060	15
Swell™ Dental Implant 5.0D 6.25L	ID0650	18	Touareg™-OS Dental Implant 6.0D 11.5L	ISF1160	15
Swell™ Dental Implant 5.0D 8L	ID0850	18	Touareg™-OS Dental Implant 6.0D 13L	ISF1360	15
Swell™ Dental Implant 6.0D 10L	ID1060	18	Touareg™-OS Dental Implant 6.0D 6.25L	ISF0660	15
Swell™ Dental Implant 6.0D 11.5L	ID1160	18	Touareg™-OS Dental Implant 6.0D 8L	ISF0860	15
Swell™ Dental Implant 6.0D 13L	ID1360	18	Touareg™-S Dental Implant 3.5D 10L	ISPS1035	14
Swell™ Dental Implant 6.0D 6.25L	ID0660	18	Touareg™-S Dental Implant 3.5D 11.5L	ISPS1135	14
Swell™ Dental Implant 6.0D 8L	ID0860	18	Touareg™-S Dental Implant 3.5D 13L	ISPS1335	14
			Touareg™-S Dental Implant 3.5D 16L	ISPS1635	14
			Touareg™-S Dental Implant 3.5D 18L	ISPS1835	14
			Touareg™-S Dental Implant 3.5D 8L	ISPS0835	14
			Touareg™-S Dental Implant 3.75D 10L	ISPS1038	14
			Touareg™-S Dental Implant 3.75D 11.5L	ISPS1138	14
			Touareg™-S Dental Implant 3.75D 13L	ISPS1338	14
			Touareg™-S Dental Implant 3.75D 16L	ISPS1638	14
			Touareg™-S Dental Implant 3.75D 18L	ISPS1838	14
			Touareg™-S Dental Implant 3.75D 8L	ISPS0838	14
			Touareg™-S Dental Implant 4.2D 10L	ISPS1042	14
			Touareg™-S Dental Implant 4.2D 11.5L	ISPS1142	14
			Touareg™-S Dental Implant 4.2D 13L	ISPS1342	14
			Touareg™-S Dental Implant 4.2D 16L	ISPS1642	14
			Touareg™-S Dental Implant 4.2D 18L	ISPS1842	14
			Touareg™-S Dental Implant 4.2D 6.25L	ISPS0642	14
			Touareg™-S Dental Implant 4.2D 8L	ISPS0842	14
			Touareg™-S Dental Implant 5.0D 10L	ISPS1050	14
			Touareg™-S Dental Implant 5.0D 11.5L	ISPS1150	14
			Touareg™-S Dental Implant 5.0D 13L	ISPS1350	14
			Touareg™-S Dental Implant 5.0D 16L	ISPS1650	14
			Touareg™-S Dental Implant 5.0D 6.25L	ISPS0650	14
			Touareg™-S Dental Implant 5.0D 8L	ISPS0850	14
			Touareg™-S Dental Implant 6.0D 10L	ISPS1060	14
			Touareg™-S Dental Implant 6.0D 11.5L	ISPS1160	14
			Touareg™-S Dental Implant 6.0D 13L	ISPS1360	14
			Touareg™-S Dental Implant 6.0D 6.25L	ISPS0660	14
			Touareg™-S Dental Implant 6.0D 8L	ISPS0860	14
<b>T</b>					
Three Step Drill-Long	TD2218	33, 42, 43, 115, 122, 123			
Three Step Drill-Short	TD1511	33, 42, 43, 115, 122, 123			
Tip Drill	RS8032	42, 43, 122, 123			
Tissue Punch 5.0mmD, S-5.5	GSS055	49,129			
Titanium Abutment 5.0 mmD WIDE	RS3950	25			
Titanium Ball Cap	RS2670	27, 75, 84, 97, 109			
TMA Abutment Replica	RS5004	29, 74, 96, 108			
TMA Cementing Cone	TM0010	29, 58, 74, 96, 108			
TMA Closed Tray Transfer	RS5011	29, 74, 96, 108			
TMA Digital Model abutment Replica	RS1001	29, 59, 74, 96, 108			
TMA Healing Cap	RS5005	30, 74, 96, 108			
TMA Healing Cap	RS5003	30, 74, 96, 108			
TMA Impression Coping Open Tray	RS5006	29, 74, 96, 108			
TMA Plastic Casting Sleeve w/Prosthetic Screw	RS5001	29, 74, 96, 108			
TMA Prosthetic Screw	RS3404	30, 58, 77, 99, 111, 144			
TMA Scan Body 6mm	TM0006	29, 57, 74, 96, 108			
TMA Scan Body 9mm	TM0009	29, 57, 74, 96, 108			
TMA Scan Body Screw	TM0001	58, 57, 144			
TMA Screw For Open Tray Impression Copying	RS5008	30			
TMA Titanium Temporary Copying	RS4900	29, 74, 58, 96, 108			
TMA Titanium Temporary Copying	RS4900	29, 58, 74, 96, 108			
TMA/FC Female Hand Hex Driver-Long	RS6191	30, 38, 78, 100, 112, 161			

Description	Catalog No.	Page No.	Description	Catalog No.	Page No.
Touareg™-S Dental Implant 6.0D 8L	ISPS0860	14	UNP CloseFit™ Slim Healing Abutment 2.75mmDX2mmL	UNP0046	81
Twist Step Drill 1.8/2.5mmD x 6-13mmL	DL1325	34, 116, 122, 123	UNP CloseFit™ Slim Healing Abutment 2.75mmDX3mmL	UNP0047	81
Twist Step Drill 1.8/2.5mmD x 8-18mmL	DL1825	34, 116, 122, 123	UNP CloseFit™ Slim Healing Abutment 2.75mmDX4mmL	UNP0048	81
Twist Step Drill 2.3/2.8mmD x 6-13mmL	DL1328	34, 42, 43, 116, 122, 123, 167	UNP CloseFit™ Slim Healing Abutment 2.75mmDX5mmL	UNP0049	81
Twist Step Drill 2.3/2.8mmD x 8-18mmL	DL1828	34, 42, 43, 44, 45, 116, 122, 123, 124, 125, 165	UNP CloseFit™ Slim Healing Abutment 2.75mmDX6mmL	UNP0050	81
Twist Step Drill 2.8/3.2mmD x 6-13mmL	DL1332	34, 42, 43, 116, 122, 123, 167	UNP CloseFit™ Slim Open Tray Transfer 3.2mmDx14mmL	UNP5614	82
Twist Step Drill 2.8/3.2mmD x 8-18mmL	DL1832	34, 42, 43, 44, 45, 116, 122, 123, 124, 125, 165	UNP CloseFit™ Straight Abutment - 1mm	UNP0019	83
Twist Step Drill 3.2/3.6mmD x 6-13mmL	DL1336	34, 42, 43, 116, 122, 123, 167	UNP CloseFit™ Straight Abutment - 2mm	UNP0011	83
Twist Step Drill 3.2/3.6mmD x 8-18mmL	DL1836	34, 42, 43, 44, 45, 116, 122, 123, 124, 125, 165	UNP CloseFit™ Straight Abutment - 3mm	UNP0064	83
Twist Step Drill 3.8/4.2mmD x 6-13mmL	DL1342	34, 42, 43, 116, 122, 123, 166	UNP CloseFit™ Straight Slim Abutment - No End Line	UNP0010	83
Twist Step Drill 3.8/4.2mmD x 8-18mmL	DL1842	34, 42, 43, 44, 45, 116, 122, 123, 124, 125, 166	UNP CloseFit™ Ti Base Angular Engaged	UNP1717	140
Twist Step Drill 4.2/4.6mmD x 6-13mmL	DL1346	34, 42, 43, 116, 168	UNP CloseFit™ Ti Base Engaged	UNP1704	140
Twist Step Drill 4.2/4.6mmD x 8-18mmL	DL1846	34, 42, 43, 44, 45, 116, 122, 124, 123, 166	UNP CloseFit™ Ti Base Non Engaged	UNP1708	140
Twist Step Drill 4.8/5.2mmD x 6-13mmL	DL1352	34, 42, 43, 116, 168	UNP CloseFit™ Ti Pre Milled MDTK Abutment Blank ø11.5mm	UNP1711	140
Twist Step Drill 4.8/5.2mmD x 8-18mmL	DL1852	34, 42, 43, 116, 166	UNP CloseFit™ Ti Pre Milled MDTK Abutment Blank ø15.8mm	UNP1715	140
Twist Step Drill 5.2/5.6mmD x 6-13mmL	DL1356	34, 42, 43, 116, 168	UNP Digital Model Analog	UNP1000	82, 143
Twist Step Drill 5.2/5.6mmD x 8-18mmL	DL1856	34, 42, 43, 116, 122, 123, 167	UNP Implant Analog	UNP0007	82
<b>U</b>			UNP/NP CloseFit™ Abutment Insertion Tool	UNP1001	78
UNP 2mm Hex Handpiece Adapter - Long	UNP0074	86	<b>W</b>		
UNP 2mm Hex Handpiece Adapter - Medium	UNP0071	86	Wide Long Drill Stop Kit	S1002	166
UNP 2mm Hex Handpiece Adapter - Short	UNP0068	86	Wide Short Drill Stop Kit	S1004	168
UNP CloseFit™ Abutment Screw	UNP0001	85, 140, 144	WP 2.65mm Hex Handpiece Adapter - Long	WP0074	113, 122, 123, 124, 125
UNP CloseFit™ Angled Abutment 15° - No End Line	UNP0018	83	WP 2.65mm Hex Handpiece Adapter - Medium	WP0071	113, 122, 123, 124, 125
UNP CloseFit™ Angled Abutment 15° 1mm	UNP0063	83	WP 2.65mm Hex Handpiece Adapter - Short	WP0068	113, 122, 123, 124, 125
UNP CloseFit™ Angled Abutment 15° 2mm	UNP0015	83	WP 2.6mm Torque Driver-Long	WP0066	112
UNP CloseFit™ Angled Abutment 15° 3mm	UNP0026	83	WP 2.6mm Torque Driver-Short	WP0067	112
UNP CloseFit™ Ball Attachment 0.5mm	UNP0020	84	WP Abutment Screw	WP0001	103
UNP CloseFit™ Ball Attachment 1mm	UNP0021	84	WP Angled Abutment 15° 1mm	WP0013	106
UNP CloseFit™ Ball Attachment 2mm	UNP0022	84	WP Angled Abutment 15° 2mm	WP0014	106
UNP CloseFit™ Ball Attachment 3mm	UNP0023	84	WP Angled Abutment 15° 3mm	WP0015	106
UNP CloseFit™ Ball Attachment 4mm	UNP0024	84	WP Angled Trans Mucosal Abutment 17° 2.5mm	WP3734	107
UNP CloseFit™ Ball Attachment 5mm	UNP0025	84	WP Angled Trans Mucosal Abutment 17° 3.5mm	WP3737	107
UNP CloseFit™ Close Tray Transfer 4.0mmDx13mmL	UNP5213	82	WP Angled Trans Mucosal Abutment 30° 3mm	WP3735	107
UNP CloseFit™ Close Tray Transfer Screw	UNP5127	85	WP Angled Trans Mucosal Abutment 30° 4mm	WP3738	107
UNP CloseFit™ Conical Cover Screw	UNP0073	81	WP Ball Attachment 0.5mm	WP0051	109
UNP CloseFit™ Conical Healing Abutment 4mmDX2mmL	UNP0090	81	WP Ball Attachment 1mm	WP0052	109
UNP CloseFit™ Conical Healing Abutment 4mmDX3mmL	UNP0091	81	WP Ball Attachment 2mm	WP0053	109
UNP CloseFit™ Conical Healing Abutment 4mmDX4mmL	UNP0092	81	WP Ball Attachment 3mm	WP0054	109
UNP CloseFit™ Conical Healing Abutment 4mmDX5mmL	UNP0093	81	WP Ball Attachment 4mm	WP0055	109
UNP CloseFit™ Conical Healing Abutment 4mmDX6mmL	UNP0094	81	WP Ball Attachment 5mm	WP0056	109
UNP CloseFit™ Engaging Temporary Abutment	UNP0043	83	WP CloseFit™ Close Tray Transfer 5.2mmDx13mmL	WP5213	105
UNP CloseFit™ Healing Abutment 4mmDX2mmL	UNP0004	81	WP CloseFit™ Close Tray Transfer 5.2mmDx9mmL	WP5209	105
UNP CloseFit™ Healing Abutment 4mmDX3mmL	UNP0008	81	WP CloseFit™ Close Tray Transfer Screw Long	WP5127	111
UNP CloseFit™ Healing Abutment 4mmDX4mmL	UNP0009	81	WP CloseFit™ Close Tray Transfer Screw Short	WP5126	111
UNP CloseFit™ Healing Abutment 4mmDX5mmL	UNP0012	81	WP CloseFit™ Open Tray Transfer 5.2mmDx10mmL	WP5510	105
UNP CloseFit™ Healing Abutment 4mmDX6mmL	UNP0013	81	WP CloseFit™ Open Tray Transfer 5.2mmDx14mmL	WP5514	105
UNP CloseFit™ Non Engaging Temporary Abutment	UNP0044	83	WP CloseFit™ Open Tray Transfer Screw Long	WP5014	111
UNP CloseFit™ One Piece Screw-In Abutment 1mm	UNP3812	83	WP CloseFit™ Open Tray Transfer Screw Short	WP5010	111
UNP CloseFit™ One Piece Screw-In Abutment 2mm	UNP3813	83	WP CloseFit™ Scan Body 10mm	WP0089	105, 142
UNP CloseFit™ One Piece Screw-In Abutment 3mm	UNP3814	83	WP CloseFit™ Scan Body 7mm	WP0088	105, 142
UNP CloseFit™ Open Tray Transfer 4mmDx14mmL	UNP5514	82	WP CloseFit™ Slim Close Tray Transfer 4mmDx13mmL	WP5113	105
UNP CloseFit™ Open Tray Transfer Screw	UNP5014	85	WP CloseFit™ Slim Close Tray Transfer 4mmDx9mmL	WP5109	105
UNP CloseFit™ Plastic Cylinder Abutment	UNP0045	83	WP CloseFit™ Slim Open Tray Transfer 4mmDx10mmL	WP5610	105
UNP CloseFit™ Scan Body 10mm	UNP0089	80, 138	WP CloseFit™ Slim Open Tray Transfer 4mmDx14mmL	WP5614	105
UNP CloseFit™ Scan Body 7mm	UNP0088	80, 138	WP CloseFit™ Ti Base Angular Engaged	WP1317	142
UNP CloseFit™ Slim Close Tray Transfer 3.2mmDx13mmL	UNP5113	82			

Description	Catalog No.	Page No.	Description	Catalog No.	Page No.
WP CloseFit™ Ti Base Engaged	WP1304	142	WP Healing Abutment 5.5mmD x 6mmL	WP0026	103
WP CloseFit™ Ti Base Non Engaged	WP1308	142	WP Implant Analog	WP0007	105
WP CloseFit™ Ti Pre Milled MDTK Abutment Blank ø11.5mm	WP1311	142	WP Non-Engaging Temporary Abutment	WP0044	106
WP CloseFit™ Ti Pre Milled MDTK Abutment Blank ø15.8mm	WP1315	142	WP Non-Engaging Titanium/Plastic Abutment	WP3097	106
WP CloseFit™ Wide Close Tray Transfer 6mmDx13mmL	WP5313	105	WP Plastic Cylinder Abutment	WP0045	106
WP CloseFit™ Wide Close Tray Transfer 6mmDx9mmL	WP5309	105	WP Retaining Screw for Angled TMA	WP3403	111
WP CloseFit™ Wide Open Tray Transfer 6mmDx10mmL	WP5410	105	WP Retaining Screw for TMA 1mm	WP3406	111
WP CloseFit™ Wide Open Tray Transfer 6mmDx14mmL	WP5414	105	WP Retaining Screw for TMA 2mm	WP3407	111
WP Conical Healing Abutment 5.5mmD x 2mmL	WP0090	103	WP Retaining Screw for TMA 3mm	WP3408	111
WP Conical Healing Abutment 5.5mmD x 3mmL	WP0091	103	WP Retaining Screw for TMA 4mm	WP3409	111
WP Conical Healing Abutment 5.5mmD x 4mmL	WP0092	103	WP Retaining Screw for TMA 5mm	WP3412	111
WP Conical Healing Abutment 5.5mmD x 5mmL	WP0093	103	WP Retrieval Screw for Abutments	WP3401	111, 161
WP Conical Healing Abutment 5.5mmD x 6mmL	WP0094	103	WP Retrieval Screw for Abutments	WP3401	111, 161
WP Conical Implant Cover Screw	WP0073	103	WP Slim Healing Abutment 4mmD x 2mmL	WP0046	103
WP Digital Model Analog	WP1000	105, 143	WP Slim Healing Abutment 4mmD x 3mmL	WP0047	103
WP Engaging Temporary Abutment	WP0043	106	WP Slim Healing Abutment 4mmD x 4mmL	WP0048	103
WP Engaging Titanium/Plastic Abutment	WP3095	106	WP Slim Healing Abutment 4mmD x 5mmL	WP0049	103
WP Flat Connection Abutment 2mm	WP0030	110	WP Slim Healing Abutment 4mmD x 6mmL	WP0050	103
WP Flat Connection Abutment 4mm	WP0031	110	WP Straight Abutment 1mm	WP0012	106
WP Handpiece Hex Adapter-Long	WP0072	113	WP Straight Abutment 2mm	WP0011	106
WP Handpiece Hex Adapter-Short	WP0062	113	WP Straight Abutment 3mm	WP0010	106
WP Healing Abutment 5.5mmD x 2mmL	WP0022	103	WP Straight Slim Abutment-No End Line	WP0020	106
WP Healing Abutment 5.5mmD x 3mmL	WP0023	103	WP Straight Trans Mucosal Abutment 1mm	WP3731	107
WP Healing Abutment 5.5mmD x 4mmL	WP0024	103	WP Straight Trans Mucosal Abutment 2mm	WP3732	107
WP Healing Abutment 5.5mmD x 5mmL	WP0025	103	WP Straight Trans Mucosal Abutment 3mm	WP3733	107
			WP Straight Trans Mucosal Abutment 4mm	WP3729	107
			WP Straight Trans Mucosal Abutment 5mm	WP3730	107
			Wrench Ratchet	RS6100	35, 42, 45, 117
			Wrench Ratchet Surgical Instruments Handle	RA0050	36, 42, 43, 44, 45, 78, 86, 100, 112, 122, 123, 124, 125

## Index in Numerical Order

Catalog No.	Description	Page No.	Catalog No.	Description	Page No.
<b>C</b>			<b>F</b>		
CF6300	CloseFit™ Plastic Surgical Kit-Premium	122, 123	FC4502	Flat Connection Abutment 2mm	31
CF6302	CloseFit™ Plastic Surgical Kit-Advanced	122, 124	FC4504	Flat Connection Abutment 4mm	31, 76, 98, 110
CF6303	CloseFit™ Plastic Surgical Kit-Starter	122, 125	FC5512	Flat Connection Transfer Impression Coping	31, 76, 98, 110
CF6304	CloseFit™ Plastic Surgical Kit-Advanced Short Drills	124	FC5515	Flat Connection Temporary Cylinder Sleeve	31, 76, 98, 110
<b>D</b>			<b>G</b>		
DL1320	Pilot Drill 2mmD x 6-13mmL	34, 42, 43, 116, 122, 123, 167	GS0010	Ratchet 4mm Hex	51
DL1325	Twist Step Drill 1.8/2.5mmD x 6-13mmL	34, 116, 122, 123	GS0020	2.0mmD Sleeve	52, 134
DL1328	Twist Step Drill 2.3/2.8mmD x 6-13mmL	34, 42, 43, 116, 122, 123, 167	GS0021	Handpiece Socket L10.5	51, 131, 133
DL1332	Twist Step Drill 2.8/3.2mmD x 6-13mmL	34, 42, 43, 116, 122, 123, 167	GS0022	Handpiece Socket L14.5	51
DL1336	Twist Step Drill 3.2/3.6mmD x 6-13mmL	34, 42, 43, 116, 122, 123, 167	GS0023	Manual Socket L10.5	51, 131, 133
DL1342	Twist Step Drill 3.8/4.2mmD x 6-13mmL	34, 42, 43, 116, 122, 123, 166	GS0024	Manual Socket L14.5	51, 131, 133
DL1346	Twist Step Drill 4.2/4.6mmD x 6-13mmL	34, 42, 43, 116, 168	GS0027	Guide Fixation Screw Driver	51, 131, 133
DL1352	Twist Step Drill 4.8/5.2mmD x 6-13mmL	34, 42, 43, 116, 168	GS0028	Handpiece Guide Fixation Screw Driver	51, 131, 133
DL1356	Twist Step Drill 5.2/5.6mmD x 6-13mmL	34, 42, 43, 116, 168	GS0029	RS Screw Fixture Mount	51
DL1820	Pilot Drill 2mmD x 8-18mmL	34, 42, 43, 44, 45, 116, 122, 123, 124, 125, 165	GS0032	RS Handpiece Fixture Mount	51
DL1825	Twist Step Drill 1.8/2.5mmD x 8-18mmL	34, 116, 122, 123	GS0033	Narrow Implants 3.3mmD Sleeve	130, 134
DL1828	Twist Step Drill 2.3/2.8mmD x 8-18mmL	34, 42, 43, 44, 45, 116, 122, 123, 124, 125, 165	GS0035	RS Extraction Tool	51
DL1832	Twist Step Drill 2.8/3.2mmD x 8-18mmL	34, 42, 43, 44, 45, 116, 122, 123, 124, 125, 165	GS0036	Extraction Tool Spanner	51
DL1836	Twist Step Drill 3.2/3.6mmD x 8-18mmL	34, 42, 43, 44, 45, 116, 122, 123, 124, 125, 165	GS0055	5.5mmD Sleeve	128, 132, 134
DL1842	Twist Step Drill 3.8/4.2mmD x 8-18mmL	34, 42, 43, 44, 45, 116, 122, 123, 124, 125, 166	GS0625	Pilot Drill S-5.5, 2.5/1.8mmDx6.0mmL	49, 129
DL1846	Twist Step Drill 4.2/4.6mmD x 8-18mmL	34, 42, 43, 44, 45, 116, 122, 124, 123, 166			
DL1852	Twist Step Drill 4.8/5.2mmD x 8-18mmL	34, 42, 43, 116, 166			
DL1856	Twist Step Drill 5.2/5.6mmD x 8-18mmL	34, 42, 43, 116, 122, 123, 167			

Catalog No.	Description	Page No.	Catalog No.	Description	Page No.
GS0632	Drill S-5.5, 3.2/2.5mmDx6.25mmL	49, 129	ID1633	Swell™ Dental Implant 3.3D 16L	18
GS0638	Drill S-5.5, 3.85/3.2mmDx6.25mmL	49, 129	ID1638	Swell™ Dental Implant 3.75D 16L	18
GS0646	Drill S-5.5, 4.6/3.85mmDx6.25mmL	49, 129	ID1642	Swell™ Dental Implant 4.2D 16L	18
GS0825	Drill S-5.5, 2.5/1.8mmDx8.0mmL	49, 129	ID1650	Swell™ Dental Implant 5.0D 16L	18
GS0832	Drill S-5.5, 3.2/2.5mmDx8.0mmL	49, 129	ID1833	Swell™ Dental Implant 3.3D 18L	18
GS0838	Drill S-5.5, 3.85/3.2mmDx8.0mmL	49, 129	ID1838	Swell™ Dental Implant 3.75D 18L	18
GS0846	Drill S-5.5, 4.6/3.85mmDx8.0mmL	49, 129	ID1842	Swell™ Dental Implant 4.2D 18L	18
GS1025	Drill S-5.5, 2.5/1.8mmDx10.0mmL	49, 129	IO1030	One™ Dental Implant 3.0D 10L	18
GS1032	Drill S-5.5, 3.2/2.5mmDx10.0mmL	49, 129	IO1033	One™ Dental Implant 3.3D 10L	18
GS1038	Drill S-5.5, 3.85/3.2mmDx10.0mmL	49, 129	IO1036	One™ Dental Implant 3.6D 10L	18
GS1046	Drill S-5.5, 4.6/3.85mmDx10.0mmL	49, 129	IO1042	One™ Dental Implant 4.2D 10L	18
GS1125	Drill S-5.5, 2.5/1.8mmDx11.5mmL	49, 129	IO1050	One™ Dental Implant 5.0D 10L	18
GS1132	Drill S-5.5, 3.2/2.5mmDx11.5mmL	49, 129	IO1130	One™ Dental Implant 3.0D 11.5L	18
GS1138	Drill S-5.5, 3.85/3.2mmDx11.5mmL	49, 129	IO1133	One™ Dental Implant 3.3D 11.5L	18
GS1146	Drill S-5.5, 4.6/3.85mmDx11.5mmL	49, 129	IO1136	One™ Dental Implant 3.6D 11.5L	18
GS1325	Drill S-5.5, 2.5/1.8mmDx13.0mmL	49, 129	IO1142	One™ Dental Implant 4.2D 11.5L	18
GS1332	Drill S-5.5, 3.2/2.5mmDx13.0mmL	49, 129	IO1150	One™ Dental Implant 5.0D 11.5L	18
GS1338	Drill S-5.5, 3.85/3.2mmDx13.0mmL	49, 129	IO1330	One™ Dental Implant 3.0D 13L	18
GS1346	Drill S-5.5, 4.6/3.85mmDx13.0mmL	49, 129	IO1333	One™ Dental Implant 3.3D 13L	18
GS1625	Drill S-5.5, 2.5/1.8mmDx16.0mmL	49, 129	IO1336	One™ Dental Implant 3.6D 13L	18
GS1632	Drill S-5.5, 3.2/2.5mmDx16.0mmL	49, 129	IO1342	One™ Dental Implant 4.2D 13L	18
GS1638	Drill S-5.5, 3.85/3.2mmDx16.0mmL	49, 129	IO1350	One™ Dental Implant 5.0D 13L	18
GS1646	Drill S-5.5, 4.6/3.85mmDx16.0mmL	49, 129	IO1530	One™ Dental Implant 3.0D 15L	18
GS1825	Drill S-5.5, 2.5/1.8mmDx18.0mmL	53, 135	IO1533	One™ Dental Implant 3.3D 15L	18
GS1832	Drill S-5.5, 3.2/2.5mmDx18.0mmL	53, 135	IO1536	One™ Dental Implant 3.6D 15L	18
GS1838	Drill S-5.5, 3.85/3.2mmDx18.0mmL	53, 135	IO1542	One™ Dental Implant 4.2D 15L	18
GS1846	Drill S-5.5, 4.6/3.85mmDx18.0mmL	53, 135	IO1550	One™ Dental Implant 5.0D 15L	18
GS1915	Anchoring Drill S-2.0, 2.0/1.5mmDx19mmL	51, 131, 133	ISF0642	Touareg™-OS Dental Implant 4.2D 6.25L	15
GS1917	Anchoring Drill S-2.0, 2.0/1.7mmDx19mmL	51, 131, 133	ISF0650	Touareg™-OS Dental Implant 5.0D 6.25L	15
GS1920	2.0D 19mmL Anchorage Screw	52, 134	ISF0660	Touareg™-OS Dental Implant 6.0D 6.25L	15
GS5055	Tissue Punch 5.0mmD, S-5.5	49, 129	ISF0835	Touareg™-OS Dental Implant 3.5D 8L	15
GSK001	Guided Surgery Drills KIT - Basic	48-49	ISF0838	Touareg™-OS Dental Implant 3.75D 8L	15
GSK003	Guided Surgery Accessories KIT - RS Implants	50-51	ISF0842	Touareg™-OS Dental Implant 4.2D 8L	15
GSN0625	Pilot Drill S-3.3, 2.5/1.8mmDx6.0mmL	131	ISF0850	Touareg™-OS Dental Implant 5.0D 8L	15
GSN1025	Drill S-3.3, 2.5/1.8mmDx10.0mmL	131	ISF0860	Touareg™-OS Dental Implant 6.0D 8L	15
GSN1125	Drill S-3.3, 2.5/1.8mmDx11.5mmL	131	ISF1035	Touareg™-OS Dental Implant 3.5D 10L	15
GSN1325	Drill S-3.3, 2.5/1.8mmDx13.0mmL	131	ISF1038	Touareg™-OS Dental Implant 3.75D 10L	15
GSN1625	Drill S-3.3, 2.5/1.8mmDx16.0mmL	131	ISF1042	Touareg™-OS Dental Implant 4.2D 10L	15
GSN1825	Drill S-3.3, 2.5/1.8mmDx18.0mmL	53, 135	ISF1050	Touareg™-OS Dental Implant 5.0D 10L	15
GSN3033	Narrow Tissue Punch 3.0mmD, S-3.3	131	ISF1060	Touareg™-OS Dental Implant 6.0D 10L	15
			ISF1135	Touareg™-OS Dental Implant 3.5D 11.5L	15
			ISF1138	Touareg™-OS Dental Implant 3.75D 11.5L	15
			ISF1142	Touareg™-OS Dental Implant 4.2D 11.5L	15
ID0642	Swell™ Dental Implant 4.2D 6.25L	18	ISF1150	Touareg™-OS Dental Implant 5.0D 11.5L	15
ID0650	Swell™ Dental Implant 5.0D 6.25L	18	ISF1160	Touareg™-OS Dental Implant 6.0D 11.5L	15
ID0660	Swell™ Dental Implant 6.0D 6.25L	18	ISF1335	Touareg™-OS Dental Implant 3.5D 13L	15
ID0838	Swell™ Dental Implant 3.75D 8L	18	ISF1338	Touareg™-OS Dental Implant 3.75D 13L	15
ID0842	Swell™ Dental Implant 4.2D 8L	18	ISF1342	Touareg™-OS Dental Implant 4.2D 13L	15
ID0850	Swell™ Dental Implant 5.0D 8L	18	ISF1350	Touareg™-OS Dental Implant 5.0D 13L	15
ID0860	Swell™ Dental Implant 6.0D 8L	18	ISF1360	Touareg™-OS Dental Implant 6.0D 13L	15
ID1033	Swell™ Dental Implant 3.3D 10L	14	ISF1635	Touareg™-OS Dental Implant 3.5D 16L	15
ID1038	Swell™ Dental Implant 3.75D 10L	18	ISF1638	Touareg™-OS Dental Implant 3.75D 16L	15
ID1042	Swell™ Dental Implant 4.2D 10L	18	ISF1642	Touareg™-OS Dental Implant 4.2D 16L	15
ID1050	Swell™ Dental Implant 5.0D 10L	18	ISF1650	Touareg™-OS Dental Implant 5.0D 16L	15
ID1060	Swell™ Dental Implant 6.0D 10L	18	ISF1835	Touareg™-OS Dental Implant 3.5D 18L	15
ID1133	Swell™ Dental Implant 3.3D 11.5L	18	ISF1838	Touareg™-OS Dental Implant 3.75D 18L	15
ID1138	Swell™ Dental Implant 3.75D 11.5L	18	ISF1842	Touareg™-OS Dental Implant 4.2D 18L	15
ID1142	Swell™ Dental Implant 4.2D 11.5L	18	ISPNP1030	CloseFit™ NP Dental Implant 3.0D 10L	68
ID1150	Swell™ Dental Implant 5.0D 11.5L	18	ISPNP1130	CloseFit™ NP Dental Implant 3.0D 11.5L	68
ID1160	Swell™ Dental Implant 6.0D 11.5L	18	ISPNP1330	CloseFit™ NP Dental Implant 3.0D 13L	68
ID1333	Swell™ Dental Implant 3.3D 13L	18	ISPNP1630	CloseFit™ NP Dental Implant 3.0D 16L	68
ID1338	Swell™ Dental Implant 3.75D 13L	18	ISPNP1830	CloseFit™ NP Dental Implant 3.0D 18L	68
ID1342	Swell™ Dental Implant 4.2D 13L	18	ISPS0642	Touareg™-S Dental Implant 4.2D 6.25L	14
ID1350	Swell™ Dental Implant 5.0D 13L	18	ISPS0650	Touareg™-S Dental Implant 5.0D 6.25L	14
ID1360	Swell™ Dental Implant 6.0D 13L	18	ISPS0660	Touareg™-S Dental Implant 6.0D 6.25L	14

Catalog No.	Description	Page No.	Catalog No.	Description	Page No.
ISPS0835	Touareg™-S Dental Implant 3.5D 8L	14	NP0014	NP Retrieval Screw for Abutments	85, 77, 161
ISPS0838	Touareg™-S Dental Implant 3.75D 8L	14	NP0015	NP CloseFit™ Angled Abutment 15° 1mm	72
ISPS0842	Touareg™-S Dental Implant 4.2D 8L	14	NP0018	NP CloseFit™ Angled Abutment 15° - No End Line	72
ISPS0850	Touareg™-S Dental Implant 5.0D 8L	14	NP0019	NP Straight Abutment 1mm	72
ISPS0860	Touareg™-S Dental Implant 6.0D 8L	14	NP0020	NP Ball Attachment 0.5mm	75
ISPS1035	Touareg™-S Dental Implant 3.5D 10L	14	NP0021	NP Ball Attachment 1mm	75
ISPS1038	Touareg™-S Dental Implant 3.75D 10L	14	NP0022	NP Ball Attachment 2mm	75
ISPS1042	Touareg™-S Dental Implant 4.2D 10L	14	NP0023	NP Ball Attachment 3mm	75
ISPS1050	Touareg™-S Dental Implant 5.0D 10L	14	NP0024	NP Ball Attachment 4mm	75
ISPS1060	Touareg™-S Dental Implant 6.0D 10L	14	NP0025	NP CloseFit™ Angled Abutment 25° - No End Line	72
ISPS1135	Touareg™-S Dental Implant 3.5D 11.5L	14	NP0026	NP CloseFit™ Angled Abutment 15° 2mm	72
ISPS1138	Touareg™-S Dental Implant 3.75D 11.5L	14	NP0030	NP Flat Connection Abutment 2mm	76
ISPS1142	Touareg™-S Dental Implant 4.2D 11.5L	14	NP0031	NP Flat Connection Abutment 4mm	76
ISPS1150	Touareg™-S Dental Implant 5.0D 11.5L	14	NP0032	NP Straight Trans Mucosal Abutment 1mm	73
ISPS1160	Touareg™-S Dental Implant 6.0D 11.5L	14	NP0033	NP Straight Trans Mucosal Abutment 2mm	73
ISPS1335	Touareg™-S Dental Implant 3.5D 13L	14	NP0034	NP Straight Trans Mucosal Abutment 3mm	73
ISPS1338	Touareg™-S Dental Implant 3.75D 13L	14	NP0035	NP Angled Trans Mucosal Abutment 17° L=3mm	73
ISPS1342	Touareg™-S Dental Implant 4.2D 13L	14	NP0036	NP Angled Trans Mucosal Abutment 30° L=3.5mm	73
ISPS1350	Touareg™-S Dental Implant 5.0D 13L	14	NP0037	NP Angled Trans Mucosal Abutment 30° L=5mm	73
ISPS1360	Touareg™-S Dental Implant 6.0D 13L	14	NP0038	NP Angled Trans Mucosal Abutment 17° L=4mm	73
ISPS1635	Touareg™-S Dental Implant 3.5D 16L	14	NP0039	NP Retaining Screw for TMA 1mm	77
ISPS1638	Touareg™-S Dental Implant 3.75D 16L	14	NP0040	NP Retaining Screw for TMA 2mm	77
ISPS1642	Touareg™-S Dental Implant 4.2D 16L	14	NP0041	NP Retaining Screw for TMA 3mm	77
ISPS1650	Touareg™-S Dental Implant 5.0D 16L	14	NP0042	NP Retaining Screw for Angled TMA	77
ISPS1835	Touareg™-S Dental Implant 3.5D 18L	14	NP0043	NP Engaging Temporary Abutment	72
ISPS1838	Touareg™-S Dental Implant 3.75D 18L	14	NP0044	NP Non Engaging Temporary Abutment	72
ISPS1842	Touareg™-S Dental Implant 4.2D 18L	14	NP0045	NP Plastic Cylinder Abutment	72
ISPUNP1027	CloseFit™ UNP Dental Implant 2.75D 10L	80	NP0046	NP Slim Healing Abutment 3mmD x 2mmL	69
ISPUNP1127	CloseFit™ UNP Dental Implant 2.75D 11.5L	80	NP0047	NP Slim Healing Abutment 3mmD x 3mmL	69
ISPUNP1327	CloseFit™ UNP Dental Implant 2.75D 13L	80	NP0048	NP Slim Healing Abutment 3mmD x 4mmL	69
ISPUNP1627	CloseFit™ UNP Dental Implant 2.75D 16L	80	NP0049	NP Slim Healing Abutment 3mmD x 5mmL	69
ISPUNP1827	CloseFit™ UNP Dental Implant 2.75D 18L	80	NP0050	NP Slim Healing Abutment 3mmD x 6mmL	69
ISPX0835	CloseFit™ RP Dental Implant 3.5D 8.0L	90	NP0062	NP 2mm Hex Handpiece Adapter - Short	79
ISPX0843	CloseFit™ WP Dental Implant 4.3D 8.0L	102	NP0063	NP CloseFit™ Angled Abutment 15° 3mm	72
ISPX0849	CloseFit™ WP Dental Implant 5D 8.0L	102	NP0064	NP Straight Abutment 3mm	72
ISPX1035	CloseFit™ RP Dental Implant 3.5D 10L	90	NP0068	NP 2mm Hex Handpiece Adapter - Short	79, 122, 123, 124, 125
ISPX1043	CloseFit™ WP Dental Implant 4.3D 10L	102	NP0071	NP 2mm Hex Handpiece Adapter - Medium	79, 122, 123, 124, 125
ISPX1049	CloseFit™ WP Dental Implant 5D 10L	102	NP0072	NP 2mm Hex Handpiece Adapter - Long	79
ISPX1135	CloseFit™ RP Dental Implant 3.5D 11.5L	90	NP0073	NP Conical Implant Cover Screw	69
ISPX1143	CloseFit™ WP Dental Implant 4.3D 11.5L	102	NP0074	NP 2mm Hex Handpiece Adapter - Long	79, 122, 123, 124, 125
ISPX1149	CloseFit™ WP Dental Implant 5D 11.5L	102	NP0088	NP CloseFit™ Scan Body 7mm	71, 139
ISPX1335	CloseFit™ RP Dental Implant 3.5D 13L	90	NP0089	NP CloseFit™ Scan Body 10mm	71, 139
ISPX1343	CloseFit™ WP Dental Implant 4.3D 13L	102	NP0090	NP Conical Healing Abutment 4.5mmD x 2mmL	69
ISPX1349	CloseFit™ WP Dental Implant 5D 13L	102	NP0091	NP Conical Healing Abutment 4.5mmD x 3mmL	69
ISPX1535	CloseFit™ RP Dental Implant 3.5D 15L	90	NP0092	NP Conical Healing Abutment 4.5mmD x 4mmL	69
ISPX1543	CloseFit™ WP Dental Implant 4.3D 15L	102	NP0093	NP Conical Healing Abutment 4.5mmD x 5mmL	69
ISPX1549	CloseFit™ WP Dental Implant 5D 15L	102	NP0094	NP Conical Healing Abutment 4.5mmD x 6mmL	69
ISPX1835	CloseFit™ RP Dental Implant 3.5D 18L	90	NP1000	NP Digital Model Analog	71,143
ISPX1843	CloseFit™ WP Dental Implant 4.3D 18L	102	NP1004	NP CloseFit™ Ti Base Engaged	139
ISPX1849	CloseFit™ WP Dental Implant 5D 18L	102	NP1008	NP CloseFit™ Ti Base Non Engaged	139
			NP1017	NP CloseFit™ Ti Base Angular Engaged	139
			NP1111	NP CloseFit™ Ti Pre Milled MDTK Abutment Blank ø11.5mm	139
			NP1115	NP CloseFit™ Ti Pre Milled MDTK Abutment Blank ø15.8mm	139
			NP3095	NP Engaging Titanium/Plastic Abutment	72
			NP3097	NP Non-Engaging Titanium/Plastic Abutment	72
			NP3409	NP Retaining Screw for TMA 4mm	77
			NP3412	NP Retaining Screw for TMA 5mm	77
			NP3729	NP Straight Trans Mucosal Abutment 4mm	73
			NP3730	NP Straight Trans Mucosal Abutment 5mm	73
			NP5014	NP CloseFit™ Open Tray Transfer Screw	77
NP0001	NP Abutment Screw	77, 85, 139, 144			
NP0004	NP Healing Abutment 4.5mmD x 2mmL	69			
NP0005	NP 2mm Hex Torque Driver - Long	78			
NP0006	NP 2mm Hex Torque Driver - Short	78			
NP0007	NP Implant Analog	71			
NP0008	NP Healing Abutment 4.5mmD x 3mmL	69			
NP0009	NP Healing Abutment 4.5mmD x 4mmL	69			
NP0010	NP Straight Slim Abutment - No End Line	72			
NP0011	NP Straight Abutment 2mm	72			
NP0012	NP Healing Abutment 4.5mmD x 5mmL	69			
NP0013	NP Healing Abutment 4.5mmD x 6mmL	69			

## N

Catalog No.	Description	Page No.	Catalog No.	Description	Page No.
NP5113	NP CloseFit™ Slim Close Tray Transfer 3.2mmDx13mmL	71	RP0074	RP 2.25mm Hex Handpiece Adapter - Long	101, 122, 123, 124, 125
NP5127	NP CloseFit™ Close Tray Transfer Screw	77	RP0088	RP CloseFit™ Scan Body 7mm	93, 141
NP5213	NP CloseFit™ Close Tray Transfer 4.2mmDx13mmL	71	RP0089	RP CloseFit™ Scan Body 10mm	93, 141
NP5514	NP CloseFit™ Open Tray Transfer 4.2mmDx14mmL	71	RP0090	RP Conical Healing Abutment 4.5mmD x 2mmL	91
NP5614	NP CloseFit™ Slim Open Tray Transfer 3.2mmDx14mmL	71	RP0091	RP Conical Healing Abutment 4.5mmD x 3mmL	91
			RP0092	RP Conical Healing Abutment 4.5mmD x 4mmL	91
			RP0093	RP Conical Healing Abutment 4.5mmD x 5mmL	91
			RP0094	RP Conical Healing Abutment 4.5mmD x 6mmL	91
<b>P</b>			RP1000	RP Digital Model Analog	93, 143
PK6300	Prosthetic Kit Metal	160-161	RP1204	RP CloseFit™ Ti Base Engaged	141
			RP1208	RP CloseFit™ Ti Base Non Engaged	141
			RP1211	RP CloseFit™ Ti Pre Milled MDTK Abutment Blank ø11.5mm	141
<b>R</b>			RP1215	RP CloseFit™ Ti Pre Milled MDTK Abutment Blank ø15.8mm	141
RA0050	Wrench Ratchet Surgical Instruments	36, 42, 43, 44, 45, 78, 86, 100, 112,	RP1217	RP CloseFit™ Ti Base Angular Engaged	141
	Handle	122, 123, 124, 125	RP3095	RP Engaging Titanium/Plastic Abutment	94
RP0001	RP Abutment Screw	99, 141, 144	RP3097	RP Non-Engaging Titanium/Plastic Abutment	94
RP0004	Star Hand Driver - Long	30, 38, 78, 86, 100, 112, 122, 123, 124, 125, 131, 133, 161	RP3401	RP Retrieval Screw for Abutments	99, 161
RP0005	Star Torque Driver - Long	30, 37, 78, 86, 100, 112, 161	RP3403	RP Retaining Screw for Angled TMA	99
RP0007	RP Implant Analog	93	RP3409	RP Retaining Screw for TMA 4mm	99
RP0010	RP Straight Abutment 3mm	94	RP3412	RP Retaining Screw for TMA 5mm	99
RP0011	RP Straight Abutment 2mm	94	RP3729	RP Straight Trans Mucosal Abutment 4 mm	95
RP0012	RP Straight Abutment 1mm	94	RP3730	RP Straight Trans Mucosal Abutment 5 mm	95
RP0013	RP Angled Abutment 15° 1mm	94	RP3734	RP Angled Trans Mucosal Abutment 17° 2.5mm	95
RP0014	RP Angled Abutment 15° 2mm	94	RP3735	RP Angled Trans Mucosal Abutment 30° 3mm	95
RP0015	RP Angled Abutment 15° 3mm	94	RP3737	RP Angled Trans Mucosal Abutment 17° 3.5mm	95
RP0018	Star Handpiece Driver - Short	79, 86, 101, 113, 161	RP3738	RP Angled Trans Mucosal Abutment 30° 4mm	95
RP0019	Star Handpiece Driver - Long	79, 86, 101, 113, 161	RP5010	RP CloseFit™ Open Tray Transfer Screw Short	99
RP0020	RP Straight Slim Abutment - No End Line	94	RP5014	RP CloseFit™ Open Tray Transfer Screw Long	99
RP0022	RP Healing Abutment 4.5mmD x 2mmL	91	RP5109	RP CloseFit™ Slim Close Tray Transfer 3.6mmDx9mmL	93
RP0023	RP Healing Abutment 4.5mmD x 3mmL	91	RP5113	RP CloseFit™ Slim Close Tray Transfer 3.6mmDx13mmL	93
RP0024	RP Healing Abutment 4.5mmD x 4mmL	91	RP5126	RP CloseFit™ Close Tray Transfer Screw Short	99
RP0025	RP Healing Abutment 4.5mmD x 5mmL	91	RP5127	RP CloseFit™ Close Tray Transfer Screw Long	99
RP0026	RP Healing Abutment 4.5mmD x 6mmL	91	RP5209	RP CloseFit™ Close Tray Transfer 4.2mmDx9mmL	93
RP0030	RP Flat Connection Abutment 2mm	98	RP5213	RP CloseFit™ Close Tray Transfer 4.2mmDx13mmL	93
RP0031	RP Flat Connection Abutment 4mm	98	RP5510	RP CloseFit™ Open Tray Transfer 4.2mmDx10mmL	93
RP0032	RP Straight Trans Mucosal Abutment 1mm	95	RP5514	RP CloseFit™ Open Tray Transfer 4.2mmDx14mmL	93
RP0033	RP Straight Trans Mucosal Abutment 2mm	95	RP5610	RP CloseFit™ Slim Open Tray Transfer 3.6mmDx10mmL	93
RP0034	RP Straight Trans Mucosal Abutment 3mm	95	RP5614	RP CloseFit™ Slim Open Tray Transfer 3.6mmDx14mmL	93
RP0039	RP Retaining Screw for TMA 1mm	99	RS0010	RS Straight Abutment 1mmL	24
RP0040	RP Retaining Screw for TMA 2mm	99	RS0011	RS Straight Abutment 2mmL	24
RP0041	RP Retaining Screw for TMA 3mm	99	RS0012	RS Straight Abutment 3mmL	24
RP0043	RP Engaging Temporary Abutment	94	RS0088	RS Scan Body 7mm	23, 56
RP0044	RP Non-Engaging Temporary Abutment	94	RS0089	RS Scan Body 10mm	23, 56
RP0045	RP Plastic Cylinder Abutment	94	RS1000	RS Digital Model Analog	23, 59
RP0046	RP Slim Healing Abutment 3.5mmD x 2mmL	91	RS1001	TMA Digital Model abutment Replica	29, 59, 74, 96, 108
RP0047	RP Slim Healing Abutment 3.5mmD x 3mmL	91	RS1002	Retaining Screw for Digital Model Analog	59, 143
RP0048	RP Slim Healing Abutment 3.5mmD x 4mmL	91	RS1404	RS Ti Base Engaged	57
RP0049	RP Slim Healing Abutment 3.5mmD x 5mmL	91	RS1408	RS Ti Base Non Engaged	57
RP0050	RP Slim Healing Abutment 3.5mmD x 6mmL	91	RS1411	RS Ti Pre Milled MDTK Abutment Blank ø11.5mm	57
RP0051	RP Ball Attachment 0.5mm	97	RS1415	RS Ti Pre Milled MDTK Abutment Blank ø15.8mm	57
RP0052	RP Ball Attachment 1mm	97	RS1417	RS Ti Base Angular Engaged	57
RP0053	RP Ball Attachment 2mm	97	RS2650	RS Ball Attachment 0.5mm	27
RP0054	RP Ball Attachment 3mm	97	RS2651	RS Ball Attachment 1mm	27
RP0055	RP Ball Attachment 4mm	97	RS2652	RS Ball Attachment 2mm	27
RP0056	RP Ball Attachment 5mm	97	RS2653	RS Ball Attachment 3mm	27
RP0062	RP Handpiece Hex Adapter-Short	101	RS2654	RS Ball Attachment 4mm	27
RP0064	Star Hand Driver-Short	30, 38, 78, 86, 100, 112, 122, 123, 124, 125, 161	RS2655	RS Ball Attachment 5mm	27
RP0065	Star Torque Driver-Short	30, 37, 78, 86, 100, 112, 161	RS2660	Plastic Ball Cap White	27, 75, 84, 97, 109
RP0066	RP 2.2mm Hex Torque Driver-Long	100			
RP0067	RP 2.2mm Hex Torque Driver-Short	100			
RP0068	RP 2.25mm Hex Handpiece Adapter - Short	101, 122, 123, 124, 125			
RP0071	RP 2.25mm Hex Handpiece Adapter - Medium	101, 122, 123, 124, 125			
RP0072	RP Handpiece Hex Adapter-Long	101			
RP0073	RP Conical Implant Cover Screw	91			



Catalog No.	Description	Page No.	Catalog No.	Description	Page No.
RS2662	Plastic Ball Cap Pink Soft	27, 75, 84, 97, 109	RS3812	RS One Piece Screw-In Abutment	25
RS2670	Titanium Ball Cap	27, 75, 84, 97, 109	RS3890	RS Wide Profile Titanium Abutment	25
RS2675SS	Stainless Steel Ball Cap	27, 75, 84, 97, 109	RS3903	RS Slim Titanium Abutment 3mm	25
RS2861	RS Ball Attachment 1mm w/Hex	27	RS3906	RS Slim Titanium Abutment 6mm	25
RS2862	RS Ball Attachment 2mm w/Hex	27	RS3908	RS Slim Titanium Abutment 8mm	25
RS2863	RS Ball Attachment 3mm w/Hex	27	RS3950	Titanium Abutment 5.0 mmD WIDE	25
RS2864	RS Ball Attachment 4mm w/Hex	27	RS4015	RS Angled Titanium Abutment 15°	25
RS2865	RS Ball Attachment 5mm w/Hex	27	RS4016	RS Angled Titanium Abutment 15° Long	25
RS2866	RS Ball Attachment 6mm w/Hex	27	RS4017	RS Slim Angled Abutment 15° 1mm - No End Line	25
RS3012	RS Wide Healing Abutment 6mmD x 2mmL	20	RS4018	RS Slim Angled Abutment 15° 2mm - No End Line	25
RS3013	RS Wide Healing Abutment 6mmD x 3mmL	20	RS4019	RS Slim Angled Abutment 15° 3mm - No End Line	25
RS3014	RS Wide Healing Abutment 6mmD x 4mmL	20	RS4025	RS Angled Titanium Abutment 25°	25
RS3015	RS Wide Healing Abutment 6mmD x 5mmL	20	RS4035	RS Angled Titanium Abutment 35°	25
RS3022	RS Healing Abutment 4.5mmD x 2mmL	20	RS4115	RS Esthetic Angled Titanium Abutment 15° 1mm	25
RS3023	RS Healing Abutment 4.5mmD x 3mmL	20	RS4117	RS Esthetic Angled Titanium Abutment 15° 2mm	25
RS3024	RS Healing Abutment 4.5mmD x 4mmL	20	RS4119	RS Esthetic Angled Titanium Abutment 15° 3mm	25
RS3025	RS Healing Abutment 4.5mmD x 5mmL	20	RS4510	RS Open Tray Transfer 4.5mmDx10mmL	23
RS3026	RS Healing Abutment 4.5mmD x 6mmL	20	RS4514	RS Open Tray Transfer 4.5mmDx14mmL	23
RS3027	RS Slim Healing Abutment 3.5mmD x 2mmL	20	RS4900	TMA Titanium Temporary Copying	29, 74, 58, 96, 108
RS3028	RS Slim Healing Abutment 3.5mmD x 3mmL	20	RS4900	TMA Titanium Temporary Copying	29, 58, 74, 96, 108
RS3029	RS Slim Healing Abutment 3.5mmD x 4mmL	20	RS5000	RS Engaging Plastic Cylinder Casting Abutment	26
RS3030	RS Slim Healing Abutment 3.5mmD x 5mmL	20	RS5001	TMA Plastic Casting Sleeve w/Prosthetic Screw	29, 74, 96, 108
RS3031	RS Slim Healing Abutment 3.5mmD x 6mmL	20	RS5004	TMA Abutment Replica	29, 74, 96, 108
RS3090	RS Engaging Gold/Plastic Abutment	26	RS5005	TMA Healing Cap	30, 74, 96, 108
RS3094	RS Engaging Cobalt Chrome/Plastic Abutment	26	RS5003	TMA Healing Cap	30, 74, 96, 108
RS3095	RS Engaging Titanium/Plastic Abutment	26	RS5006	TMA Impression Coping Open Tray	29, 74, 96, 108
RS3097	RS Non-Engaging Titanium/Plastic Abutment	26	RS5008	TMA Screw For Open Tray Impression Copying	30
RS3100	RS Non-Engaging Cobalt Chrome/Plastic Abutment	26	RS5010	RS Engaging Plastic Casting Standard Abutment	26
RS3400	RS Prosthetic Screw	26, 56, 58	RS5011	TMA Closed Tray Transfer	29, 74, 96, 108
RS3401	RS Retrieval Screw For Abutments	38, 161	RS5020	RS Non-Engaging Plastic Cylinder Casting Abutment	26
RS3402	RS Short Prosthetic Screw	26, 57, 58	RS5030	RS Engaging Plastic Standard Abutment	26
RS3403	RS Retaining Screw For Angled TMA	30	RS5040	RS Engaging Plastic Cylinder Abutment	26
RS3404	TMA Prosthetic Screw	30, 58, 77, 99, 111, 144	RS5050	RS Non-Engaging Plastic Standard Abutment	26
RS3406	RS Retaining Screw for TMA 1mm	30	RS5109	RS Slim Close Tray Transfer 3.5mmDx9mmL	23
RS3407	RS Retaining Screw for TMA 2mm	30	RS5113	RS Slim Close Tray Transfer 3.5mmDx13mmL	23
RS3408	RS Retaining Screw for TMA 3mm	30	RS5209	RS Close Tray Transfer 4.5mmDx9mmL	23
RS3409	RS Retaining Screw for TMA 4mm	30	RS5213	RS Close Tray Transfer 4.5mmDx13mmL	23
RS3411	RS Straight Cylindrical Titanium Abutment 2mm	25	RS5737	RS Internal Hex Implant Analog	23
RS3412	RS Retaining Screw for TMA 5mm	30	RS5740	Ball Attachment Abutment Replica	27, 75, 84, 97, 109
RS3422	RS Non-Engaging Straight Cylindrical Titanium Abutment 2mm	25	RS6011	RS 2.4 Hex Torque Driver-Short	36
RS3425	RS Screw For Closed Tray Transfer	56, 58	RS6012	RS 2.4 Hex Torque Driver-Long	36
RS3428	RS Open Tray Transfer Screw Short	26	RS6025	RS One Piece Torque Driver-Short	155
RS3429	RS Open Tray Transfer Screw Long	26	RS6026	RS One Piece Torque Driver-Long	155
RS3435	RS Implant Cover Screw	20	RS6080	1.27 Hex Torque Driver-Short	37, 161
RS3480	RS Screw for Angled Titanium Abutment	26	RS6082	1.27 Hex Torque Driver-Long	37, 161
RS3510	RS Open Tray Slim Transfer 3.6mmDx10mmL	23	RS6090	Torque Driver for Ball Attachment	27, 37, 78, 86, 100, 161
RS3514	RS Open Tray Slim Transfer 3.6mmDx14mmL	23	RS6094	1.27 Hex Hand Driver-Medium	38, 42, 43, 44, 45, 59, 143, 161
RS3729	RS Straight Trans Mucosal Abutment 4 mm	28	RS6095	1.27 Hex Hand Driver-Short	38, 42, 43, 44, 45, 59, 143, 161
RS3730	RS Straight Trans Mucosal Abutment 5 mm	28	RS6097	1.27 Hex Hand Driver-Long	38
RS3731	RS Straight Trans Mucosal Abutment 1mm	28	RS6100	Wrench Ratchet	35, 42, 45, 117
RS3732	RS Straight Trans Mucosal Abutment 2mm	28	RS6111	Surgical Torque Ratchet 35-100 Ncm	35, 42, 43, 44, 117, 122, 123, 124, 125
RS3733	RS Straight Trans Mucosal Abutment 3mm	28	RS6112	Prosthetic Torque Ratchet 15-35 Ncm	37, 117, 161
RS3734	RS Angled Trans Mucosal Abutment 17° 2mm	28	RS6150	Parallel Pin 11	36, 42, 43, 44, 118, 122, 123, 124
RS3735	RS Angled Trans Mucosal Abutment 30° 3mm	28	RS6155	Parallel Pin 16	36, 42, 43, 44, 118, 122, 123, 124
RS3736	RS Angled Trans Mucosal Abutment 45° 4mm	28	RS6180	Depth Probe	35, 42, 43, 44, 117, 122, 123, 124
RS3737	RS Angled Trans Mucosal Abutment 17° 3mm	28	RS6191	TMA/FC Female Hand Hex Driver-Long	30, 38, 78, 100, 112, 161
RS3738	RS Angled Trans Mucosal Abutment 30° 4mm	28	RS6193	TMA/FC Female Hand Hex Driver-Short	30, 38, 78, 100, 112, 161
RS3800	RS Straight Titanium Abutment - No End Line	24	RS6194	TMA/FC Hex Handpiece Adapter-Short	30, 38, 79, 101, 113, 161
RS3801	RS Straight Titanium Abutment 1mm	24	RS6195A	TMA/FC Hex Handpiece Adapter-Long	30, 38, 79, 101, 113, 161
RS3802	RS Straight Titanium Abutment 2mm	24	RS6196	TMA/FC Hex Torque Driver - Long	30, 37, 78, 100, 112, 161
RS3803	RS Straight Titanium Abutment 3mm	24	RS6197	TMA/FC Hex Torque Driver - Short	30, 37, 78, 100, 112, 161
RS3804	RS Straight Titanium Abutment 4mm	24			
RS3805	RS Straight Titanium Abutment 5 mm	24			
RS3811	RS Straight Titanium Abutment Long 12.5mm	24			

Catalog No.	Description	Page No.	Catalog No.	Description	Page No.
RS6301	RS-Standard Internal Hex Plastic Surgical Kit-Premium	42, 43	S1846L11.5	Drill Stopper for Long L11.5 1846	166
RS6322	RS-Standard Internal Hex Plastic Surgical Kit-Advanced	42, 44	S1846L13	Drill Stopper for Long L13/Short L8 1846	166
RS6333	RS-Standard Internal Hex Plastic Surgical Kit- Starter	42, 45	S1846L15	Drill Stopper for Long L15/Short L10 1846	166
RS7001	Surgical Driver	35, 117	S1846L16	Drill Stopper for Long L16 1846	166
RS8032	Tip Drill	42, 43, 122, 123	S1846L8	Drill Stopper for Long L8 1846	166
RS9020	RS Hex Handpiece Adapter-Short	36	S1852L10	Drill Stopper for Long L10 1852	166
RS9021	RS Hex Handpiece Adapter - Short	36, 42, 43, 44, 45	S1852L11.5	Drill Stopper for Long L11.5 1852	166
RS9025	RS Hex Handpiece Adapter-Long	36	S1852L13	Drill Stopper for Long L13/Short L8 1852	166
RS9026	RS Hex Handpiece Adapter - Medium	36, 42, 43, 44, 45	S1852L15	Drill Stopper for Long L15/Short L10 1852	166
RS9027	Drill Extension	36, 42, 43, 44, 122, 123, 124, 131, 133	S1852L16	Drill Stopper for Long L16 1852	166
RS9029	RS Hex Handpiece Adapter - Long	36, 42, 43, 44, 45	S1852L6	Drill Stopper for Long L6 1852	166
RS9030	1.27 Hex Driver for Handpiece - Short	38, 161	S1852L8	Drill Stopper for Long L8 1852	166
RS9035	1.27 Hex Driver for Handpiece - Long	38, 161	S1856L10	Drill Stopper for Long L10 1856	166

## S

S1001	Regular Long Drill Stop Kit	165
S1002	Wide Long Drill Stop Kit	166
S1003	Regular Short Drill Stop Kit	167
S1004	Wide Short Drill Stop Kit	168
S1320L11.5	Drill Stopper for Short L11.5 1320	167, 168
S1320L6	Drill Stopper for Short L6 1320	167, 168
S1328L11.5	Drill Stopper for Short L11.5 1328	167, 168
S1328L6	Drill Stopper for Short L6 1328	167, 168
S1332L11.5	Drill Stopper for Short L11.5 1332	167, 168
S1332L6	Drill Stopper for Short L6 1332	167, 168
S1336L11.5	Drill Stopper for Short L11.5 1336	167, 168
S1336L6	Drill Stopper for Short L6 1336	167, 168
S1820L10	Drill Stopper for Long L10 1820	165
S1820L11.5	Drill Stopper for Long L11.5 1820	165
S1820L13	Drill Stopper for Long L13/Short L8 1820	165
S1820L15	Drill Stopper for Long L15/Short L10 1820	165
S1820L16	Drill Stopper for Long L16 1820	165
S1820L6	Drill Stopper for Long L6 1820	165
S1820L8	Drill Stopper for Long L8 1820	165
S1828L10	Drill Stopper for Long L10 1828	165
S1828L11.5	Drill Stopper for Long L11.5 1828	165
S1828L13	Drill Stopper for Long L13/Short L8 1828	165, 167, 168
S1828L15	Drill Stopper for Long L15/Short L10 1828	165, 167, 168
S1828L16	Drill Stopper for Long L16 1828	165
S1828L6	Drill Stopper for Long L6 1828	165
S1828L8	Drill Stopper for Long L8 1828	165
S1832L10	Drill Stopper for Long L10 1832	165
S1832L11.5	Drill Stopper for Long L11.5 1832	165
S1832L13	Drill Stopper for Long L13/Short L8 1832	165, 167, 168
S1832L15	Drill Stopper for Long L15/Short L10 1832	165, 168
S1832L16	Drill Stopper for Long L16 1832	165
S1832L6	Drill Stopper for Long L6 1832	165
S1832L8	Drill Stopper for Long L8 1832	165
S1836L10	Drill Stopper for Long L10 1836	165
S1836L11.5	Drill Stopper for Long L11.5 1836	165
S1836L13	Drill Stopper for Long L13/Short L8 1836	165, 167, 168
S1836L15	Drill Stopper for Long L15/Short L10 1836	165, 167, 168
S1836L16	Drill Stopper for Long L16 1836	165
S1836L6	Drill Stopper for Long L6 1836	165
S1836L8	Drill Stopper for Long L8 1836	165
S1842L10	Drill Stopper for Long L10 1842	166
S1842L11.5	Drill Stopper for Long L11.5 1842	166
S1842L13	Drill Stopper for Long L13/Short L8 1842	166
S1842L15	Drill Stopper for Long L15/Short L10 1842	166
S1842L16	Drill Stopper for Long L16 1842	166
S1842L6	Drill Stopper for Long L6 1842	166
S1842L8	Drill Stopper for Long L8 1842	166
S1846L10	Drill Stopper for Long L10 1846	166

## T

TD1511	Three Step Drill-Short	33, 42, 43, 115, 122, 123
TD2218	Three Step Drill-Long	33, 42, 43, 115, 122, 123
TM0001	TMA Scan Body Screw	58, 57, 144
TM0006	TMA Scan Body 6mm	29, 57, 74, 96, 108
TM0009	TMA Scan Body 9mm	29, 57, 74, 96, 108
TM0010	TMA Cementing Cone	29, 58, 74, 96, 108

## U

UNP0074	UNP 2mm Hex Handpiece Adapter - Long	86
UNP0071	UNP 2mm Hex Handpiece Adapter - Medium	86
UNP0068	UNP 2mm Hex Handpiece Adapter - Short	86
UNP0001	UNP CloseFit™ Abutment Screw	85, 140, 144
UNP0018	UNP CloseFit™ Angled Abutment 15° - No End Line	83
UNP0063	UNP CloseFit™ Angled Abutment 15° 1mm	83
UNP0015	UNP CloseFit™ Angled Abutment 15° 2mm	83
UNP0026	UNP CloseFit™ Angled Abutment 15° 3mm	83
UNP0020	UNP CloseFit™ Ball Attachment 0.5mm	84
UNP0021	UNP CloseFit™ Ball Attachment 1mm	84
UNP0022	UNP CloseFit™ Ball Attachment 2mm	84
UNP0023	UNP CloseFit™ Ball Attachment 3mm	84
UNP0024	UNP CloseFit™ Ball Attachment 4mm	84
UNP0025	UNP CloseFit™ Ball Attachment 5mm	84
UNP5213	UNP CloseFit™ Close Tray Transfer 4.0mmX13mmL	82
UNP5127	UNP CloseFit™ Close Tray Transfer Screw	85
UNP0073	UNP CloseFit™ Conical Cover Screw	81
UNP0090	UNP CloseFit™ Conical Healing Abutment 4mmDX2mmL	81
UNP0091	UNP CloseFit™ Conical Healing Abutment 4mmDX3mmL	81
UNP0092	UNP CloseFit™ Conical Healing Abutment 4mmDX4mmL	81
UNP0093	UNP CloseFit™ Conical Healing Abutment 4mmDX5mmL	81
UNP0094	UNP CloseFit™ Conical Healing Abutment 4mmDX6mmL	81
UNP0043	UNP CloseFit™ Engaging Temporary Abutment	83
UNP0004	UNP CloseFit™ Healing Abutment 4mmDX2mmL	81
UNP0008	UNP CloseFit™ Healing Abutment 4mmDX3mmL	81
UNP0009	UNP CloseFit™ Healing Abutment 4mmDX4mmL	81
UNP0012	UNP CloseFit™ Healing Abutment 4mmDX5mmL	81
UNP0013	UNP CloseFit™ Healing Abutment 4mmDX6mmL	81
UNP0044	UNP CloseFit™ Non Engaging Temporary Abutment	83

Catalog No.	Description	Page No.	Catalog No.	Description	Page No.
UNP3812	UNP CloseFit™ One Piece Screw-In Abutment 1mm	83	WP0055	WP Ball Attachment 4mm	109
UNP3813	UNP CloseFit™ One Piece Screw-In Abutment 2mm	83	WP0056	WP Ball Attachment 5mm	109
UNP3814	UNP CloseFit™ One Piece Screw-In Abutment 3mm	83	WP0062	WP Handpiece Hex Adapter-Short	113
UNP5514	UNP CloseFit™ Open Tray Transfer 4mmDx14mmL	82	WP0066	WP 2.6mm Torque Driver-Long	112
UNP5014	UNP CloseFit™ Open Tray Transfer Screw	85	WP0067	WP 2.6mm Torque Driver-Short	112
UNP0045	UNP CloseFit™ Plastic Cylinder Abutment	83	WP0068	WP 2.65mm Hex Handpiece Adapter - Short	113, 122, 123, 124, 125
UNP0089	UNP CloseFit™ Scan Body 10mm	80, 138	WP0071	WP 2.65mm Hex Handpiece Adapter - Medium	113, 122, 123, 124, 125
UNP0088	UNP CloseFit™ Scan Body 7mm	80, 138	WP0072	WP Handpiece Hex Adapter-Long	113
UNP5113	UNP CloseFit™ Slim Close Tray Transfer 3.2mmDx13mmL	82	WP0073	WP Conical Implant Cover Screw	103
UNP0046	UNP CloseFit™ Slim Healing Abutment 2.75mmDx2mmL	81	WP0074	WP 2.65mm Hex Handpiece Adapter - Long	113, 122, 123, 124, 125
UNP0047	UNP CloseFit™ Slim Healing Abutment 2.75mmDx3mmL	81	WP0088	WP CloseFit™ Scan Body 7mm	105, 142
UNP0048	UNP CloseFit™ Slim Healing Abutment 2.75mmDx4mmL	81	WP0089	WP CloseFit™ Scan Body 10mm	105, 142
UNP0049	UNP CloseFit™ Slim Healing Abutment 2.75mmDx5mmL	81	WP0090	WP Conical Healing Abutment 5.5mmD x 2mmL	103
UNP0050	UNP CloseFit™ Slim Healing Abutment 2.75mmDx6mmL	81	WP0091	WP Conical Healing Abutment 5.5mmD x 3mmL	103
UNP5614	UNP CloseFit™ Slim Open Tray Transfer 3.2mmDx14mmL	82	WP0092	WP Conical Healing Abutment 5.5mmD x 4mmL	103
UNP0019	UNP CloseFit™ Straight Abutment - 1mm	83	WP0093	WP Conical Healing Abutment 5.5mmD x 5mmL	103
UNP0011	UNP CloseFit™ Straight Abutment - 2mm	83	WP0094	WP Conical Healing Abutment 5.5mmD x 6mmL	103
UNP0064	UNP CloseFit™ Straight Abutment - 3mm	83	WP1000	WP Digital Model Analog	105, 143
UNP0010	UNP CloseFit™ Straight Slim Abutment - No End Line	83	WP1304	WP CloseFit™ Ti Base Engaged	142
UNP1717	UNP CloseFit™ Ti Base Angular Engaged	140	WP1308	WP CloseFit™ Ti Base Non Engaged	142
UNP1704	UNP CloseFit™ Ti Base Engaged	140	WP1311	WP CloseFit™ Ti Pre Milled MDTK Abutment Blank ø11.5mm	142
UNP1708	UNP CloseFit™ Ti Base Non Engaged	140	WP1315	WP CloseFit™ Ti Pre Milled MDTK Abutment Blank ø15.8mm	142
UNP1711	UNP CloseFit™ Ti Pre Milled MDTK Abutment Blank ø11.5mm	140	WP1317	WP CloseFit™ Ti Base Angular Engaged	142
UNP1715	UNP CloseFit™ Ti Pre Milled MDTK Abutment Blank ø15.8mm	140	WP3095	WP Engaging Titanium/Plastic Abutment	106
UNP1000	UNP Digital Model Analog	82, 143	WP3097	WP Non-Engaging Titanium/Plastic Abutment	106
UNP0007	UNP Implant Analog	82	WP3401	WP Retrieval Screw for Abutments	111, 161
UNP1001	UNP/NP CloseFit™ Abutment Insertion Tool	78	WP3401	WP Retrieval Screw for Abutments	111, 161

## W

WP0001	WP Abutment Screw	103	WP3422	WP Retaining Screw for TMA 5mm	111
WP0007	WP Implant Analog	105	WP3729	WP Straight Trans Mucosal Abutment 4mm	107
WP0010	WP Straight Abutment 3mm	106	WP3730	WP Straight Trans Mucosal Abutment 5mm	107
WP0011	WP Straight Abutment 2mm	106	WP3731	WP Straight Trans Mucosal Abutment 1mm	107
WP0012	WP Straight Abutment 1mm	106	WP3732	WP Straight Trans Mucosal Abutment 2mm	107
WP0013	WP Angled Abutment 15° 1mm	106	WP3733	WP Straight Trans Mucosal Abutment 3mm	107
WP0014	WP Angled Abutment 15° 2mm	106	WP3734	WP Angled Trans Mucosal Abutment 17° 2.5mm	107
WP0015	WP Angled Abutment 15° 3mm	106	WP3735	WP Angled Trans Mucosal Abutment 30° 3mm	107
WP0020	WP Straight Slim Abutment-No End Line	106	WP3737	WP Angled Trans Mucosal Abutment 17° 3.5mm	107
WP0022	WP Healing Abutment 5.5mmD x 2mmL	103	WP3738	WP Angled Trans Mucosal Abutment 30° 4mm	107
WP0023	WP Healing Abutment 5.5mmD x 3mmL	103	WP5010	WP CloseFit™ Open Tray Transfer Screw Short	111
WP0024	WP Healing Abutment 5.5mmD x 4mmL	103	WP5014	WP CloseFit™ Open Tray Transfer Screw Long	111
WP0025	WP Healing Abutment 5.5mmD x 5mmL	103	WP5109	WP CloseFit™ Slim Close Tray Transfer 4mmDx9mmL	105
WP0026	WP Healing Abutment 5.5mmD x 6mmL	103	WP5113	WP CloseFit™ Slim Close Tray Transfer 4mmDx13mmL	105
WP0030	WP Flat Connection Abutment 2mm	110	WP5126	WP CloseFit™ Close Tray Transfer Screw Short	111
WP0031	WP Flat Connection Abutment 4mm	110	WP5127	WP CloseFit™ Close Tray Transfer Screw Long	111
WP0043	WP Engaging Temporary Abutment	106	WP5209	WP CloseFit™ Close Tray Transfer 5.2mmDx9mmL	105
WP0044	WP Non-Engaging Temporary Abutment	106	WP5213	WP CloseFit™ Close Tray Transfer 5.2mmDx13mmL	105
WP0045	WP Plastic Cylinder Abutment	106	WP5309	WP CloseFit™ Wide Close Tray Transfer 6mmDx9mmL	105
WP0046	WP Slim Healing Abutment 4mmD x 2mmL	103	WP5313	WP CloseFit™ Wide Close Tray Transfer 6mmDx13mmL	105
WP0047	WP Slim Healing Abutment 4mmD x 3mmL	103	WP5410	WP CloseFit™ Wide Open Tray Transfer 6mmDx10mmL	105
WP0048	WP Slim Healing Abutment 4mmD x 4mmL	103	WP5414	WP CloseFit™ Wide Open Tray Transfer 6mmDx14mmL	105
WP0049	WP Slim Healing Abutment 4mmD x 5mmL	103			
WP0050	WP Slim Healing Abutment 4mmD x 6mmL	103			
WP0051	WP Ball Attachment 0.5mm	109			
WP0052	WP Ball Attachment 1mm	109			
WP0053	WP Ball Attachment 2mm	109			
WP0054	WP Ball Attachment 3mm	109			





Founded in 2001, Adin Dental Implant Systems is a global leader in the design, development and manufacture of dental implant solutions & on track to become the world's leading independent dental implant provider.



---

Industrial Park Allon Tavor, POB 1128, Afula 1811101, Israel

T. +972-4-6426732 | [info@adin-implants.com](mailto:info@adin-implants.com) | [www.adin-implants.com](http://www.adin-implants.com)