

# Single TMA

Accuracy & flexibility  
for single tooth restoration

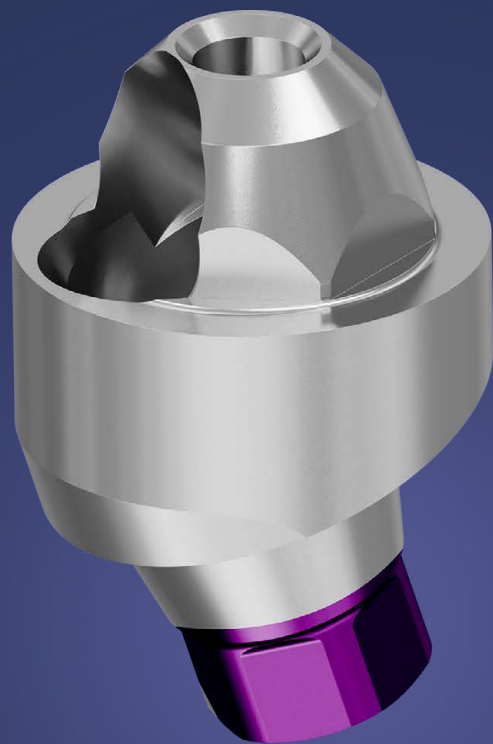





Adding to Adin's variety of the screw-retained restoration range, in comes the single TMA. Utilizing all the benefits of the TMA abutments while allowing the accuracy and flexibility for single tooth restoration.

Adin's STMA offer the possibility to combine the benefits of trans-gingival approach and screw-retained single tooth restoration yielding greater flexibility in both esthetics, safety and restoration maintenance.

Adin's Single TMA is based on the TMA abutment, while the added hex index offers both the required accurate positioning and retention to support a single tooth crown. Open and closed tray transfers as well as scan boddies for digital impression are available to match every preferred impression method as well as replicas for straight forward and simple work process.

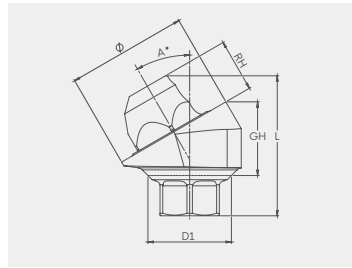
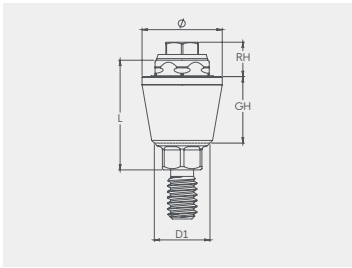





RS - Internal Hex Platform   STMA Abutments		L	D1	Ø	GH	RH	Catalog No.
	RS Straight Single TMA Abutment 1mm	3.7	3.4	4.9	1.0	2.1	RS3731S
	RS Straight Single TMA Abutment 2mm	4.7	3.4	4.9	2.0	2.1	RS3732S
	RS Straight Single TMA Abutment 3mm	5.7	3.4	4.9	3.0	2.1	RS3733S
	RS Straight Single TMA Abutment 4mm	6.7	3.4	4.9	4.0	2.1	RS3729S
	RS Straight Single TMA Abutment 5mm	7.7	3.4	4.9	5.0	2.1	RS3730S

	RS Angled Single TMA Abutment 17° 2mm	5.2	3.4	4.9	2.0	2.15	RS3734S
	RS Angled Single TMA Abutment 30° 3mm	5.7	3.4	4.9	3.0	2.15	RS3735S
	RS Angled Single TMA Abutment 17° 3mm	6.2	3.4	4.9	3.0	2.15	RS3737S
	RS Angled Single TMA Abutment 30° 4mm	6.5	3.4	4.9	4.0	2.15	RS3738S

NP CloseFit™ - Conical Connection Platform   STMA Abutments		L	D1	Ø	GH	RH	Catalog No.
	NP Straight Single TMA Abutment 1mm	4.2	2.5	4.9	1.0	2.1	NP0032S
	NP Straight Single TMA Abutment 2mm	5.2	2.5	4.9	2.0	2.1	NP0033S
	NP Straight Single TMA Abutment 3mm	6.2	2.5	4.9	3.0	2.1	NP0034S
	NP Straight Single TMA Abutment 4 mm	7.2	2.5	4.9	4.0	2.1	NP3729S
	NP Straight Single TMA Abutment 5mm	8.2	2.5	4.9	5.0	2.1	NP3730S

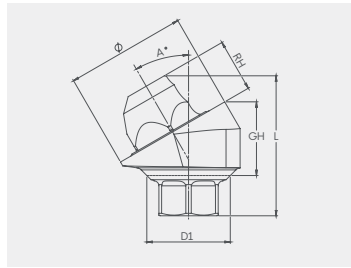
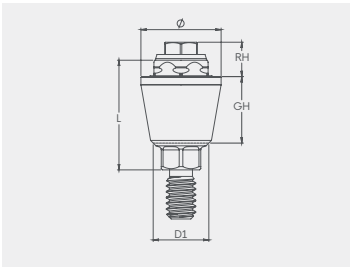
	NP Angled Single TMA Abutment 17° 3mm	6.6	2.5	4.9	2.8	2.15	NP0035S
	NP Angled Single TMA Abutment 30° 3.5mm	6.7	2.5	4.9	3.5	2.15	NP0036S
	NP Angled Single TMA Abutment 30° 5mm	8.1	2.5	4.9	4.9	2.15	NP0037S
	NP Angled Single TMA Abutment 17° 4mm	7.7	2.5	4.9	3.9	2.15	NP0038S





RP CloseFit™ - Conical Connection Platform   STMA Abutments		L	D1	Ø	GH	RH	Catalog No.
	RP Straight Single TMA Abutment 1mm	4.2	2.9	4.9	1.0	2.1	RP0032S
	RP Straight Single TMA Abutment 2mm	5.2	2.9	4.9	2.0	2.1	RP0033S
	RP Straight Single TMA Abutment 3mm	6.2	2.9	4.9	3.0	2.1	RP0034S
	RP Straight Single TMA Abutment 4mm	7.2	2.9	4.9	4.0	2.1	RP3729S
	RP Straight Single TMA Abutment 5mm	8.2	2.9	4.9	5.0	2.1	RP3730S

	RP Angled Single TMA Abutment 17° 2.5mm	6.4	2.9	4.9	2.6	2.15	RP3734S
	RP Angled Single TMA Abutment 30° 3mm	6.9	2.9	4.9	3.7	2.15	RP3735S
	RP Angled Single TMA Abutment 17° 3.5mm	7.5	2.9	4.9	3.7	2.15	RP3737S
	RP Angled Single TMA Abutment 30° 4mm	7.3	2.9	4.9	4.0	2.15	RP3738S

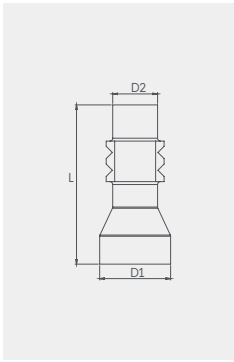

WP CloseFit™ - Conical Connection Platform   STMA Abutments		L	D1	Ø	GH	RH	Catalog No.
	WP Straight Single TMA Abutment 1mm	4.3	3.35	4.9	1.0	2.1	WP3731S
	WP Straight Single TMA Abutment 2mm	5.3	3.35	4.9	2.0	2.1	WP3732S
	WP Straight Single TMA Abutment 3mm	6.3	3.35	4.9	3.0	2.1	WP3733S
	WP Straight Single TMA Abutment 4mm	7.3	3.35	4.9	4.0	2.1	WP3729S
	WP Straight Single TMA Abutment 5mm	6.7	3.35	4.9	5.0	2.1	WP3730S

	WP Angled Single TMA Abutment 17° 2.5mm	6.4	3.35	4.9	2.5	2.15	WP3734S
	WP Angled Single TMA Abutment 30° 3mm	6.8	3.35	4.9	3.5	2.15	WP3735S
	WP Angled Single TMA Abutment 17° 3.5mm	7.4	3.35	4.9	3.5	2.15	WP3737S
	WP Angled Single TMA Abutment 30° 4mm	7.5	3.35	4.9	4.1	2.15	WP3738S



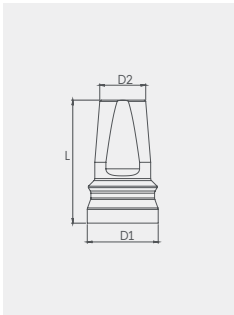

Transfers		L	D1	D2	Catalog No.
	Single TMA Open Tray Transfer	11.0	4.9	3.1	RS5006S
	Single TMA Closed Tray Transfer	8.0	4.9	4.1	RS5011S

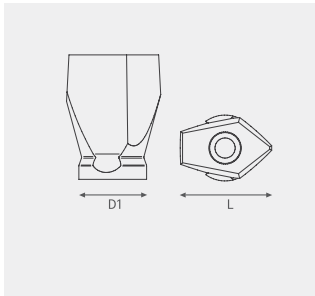

Snap-On		L	D1	D2	Catalog No.
	IRIS™, Impression coping				IR0179
	Single TMA Snap-On Transfer	8.0	4.9	3.2	RS5012S



Scan Body		L	D1	Catalog No.
	Single TMA Scan Body	6.0	4.9	TM0006S
		9.0	4.9	TM0009S

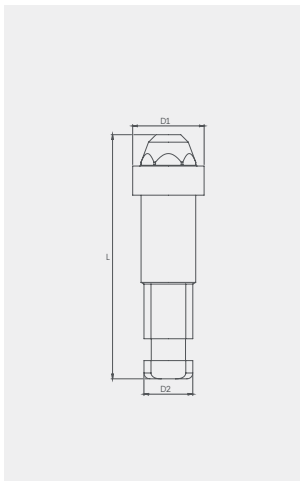

STMA Replica		L	D1	Catalog No.
	STMA Abutment Replica	16.75	4.9	RS5004S



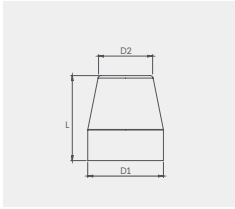

STMA Digital Model Replica		L	D1	D2	Catalog No.
	Single TMA Digital Model Abutment Replica	12.0	4.9	3.8	RS1001S

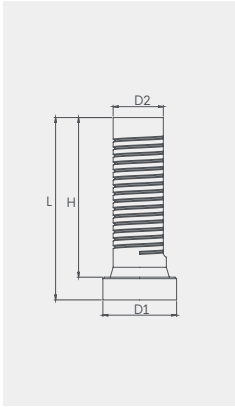

Healing Cap		L	D1	D2	Catalog No.
	Single TMA Healing Cap	5.5	4.9	3.5	RS5005S



STMA Prosthetic		L	D1	D2	H	Catalog No.
	Single TMA Titanium Temporary	12.0	4.9	3.5	10.5	RS4900S
	Single TMA Plastic Casting Sleeve w/Prosthetic Screw	12.0	4.9	3.5	10.35	RS5001S

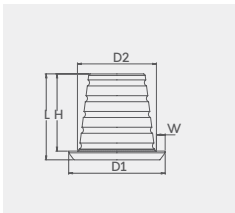

STMA Prosthetic		L	D1	D2	H	W	Catalog No.
	Single TMA Cementing Cone, low profile	4.9	5.5	4.5	4.4	0.5	TM0011S

## About Adin

---

Every business starts with a vision.

Ours is simple: We want to create the best possible dental implant solutions that offer uncompromising quality at an affordable price. It's our people that help our business thrive and grow. That's why we place so much importance on building strong personal relationships that enable us to meet our doctors and distributors' needs. Understanding that their success is our success, we're focused on providing professional, high quality and affordable solutions and exceptional service that help them grow.

