

Zygomatic

Touareg™ OS Dental Implant

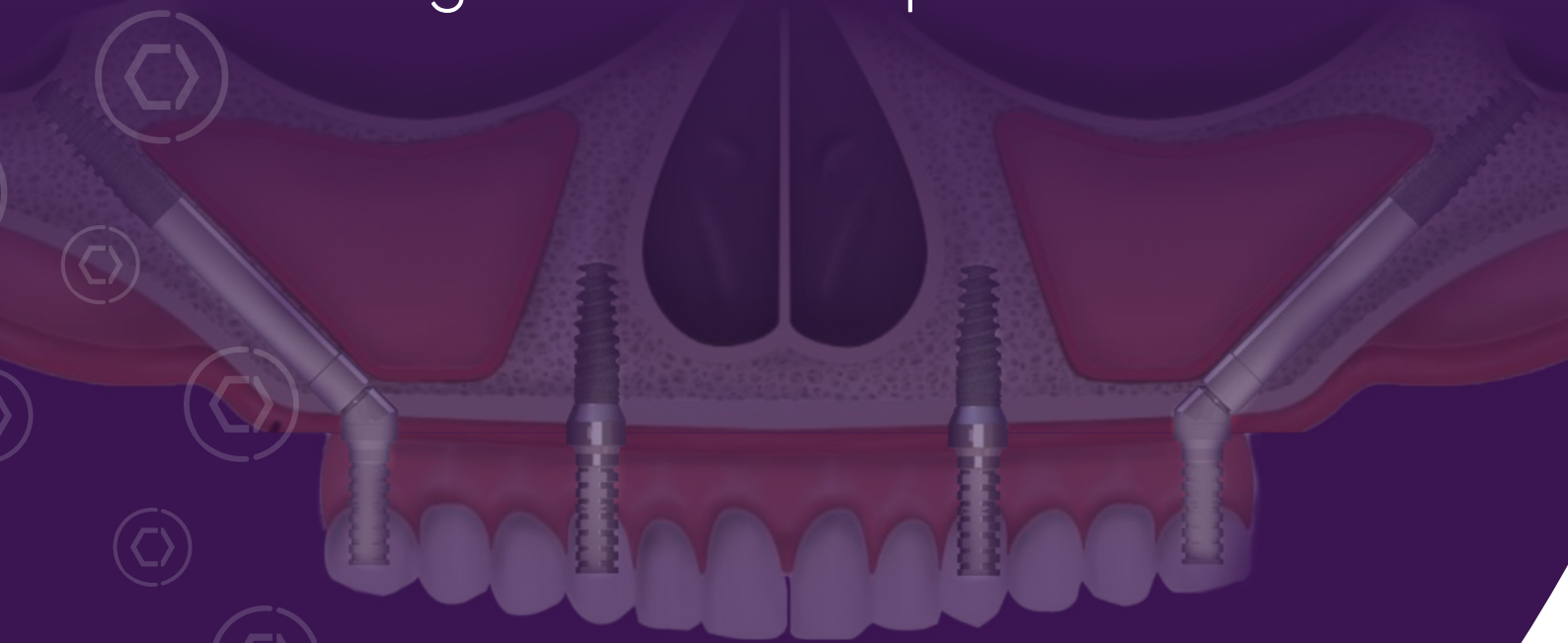



Adin Touareg™ OS Zygomatic Dental Implants are intended for immediate loading function. Implant are placed through the maxillary arch and anchored in the zygomatic bone. The Zygomatic implant provides support for prosthetic devices such as artificial teeth in order to restore the patient's chewing function in edentulous or partially edentulous patients.

Adin Touareg™ OS Zygomatic implants are intended :

- For multi-unit reconstruction (TMA), with a rigid splinting of minimum two implants.
- For an edentulous / full mouth restoration, should be used together with at least two standard implants.
- Should be used only in patients with severe atrophic maxilla.
- Intra-maxillary sinus and extra-maxillary sinus procedures and intended to be anchored in the zygoma bone.
- One stage or two stage surgical operation.

Adin Touareg™ OS Zygomatic implants are Intended for ZAGA 0-3 cases only.

Adin Touareg™ OS Zygomatic implants are NOT Intended for ZAGA 4 cases, where implant do not pass thru the maxillary alveolar bone.

Immediate loading function is applicable provided that stability requirements are satisfied.

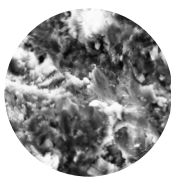

Surface Type

OsseoFix™ surface uses calcium phosphate, a biocompatible blasting media designed to achieve the desired roughness levels needed for optimal osseointegration and the highest implant surface purity levels.

Adin's Zygomatic Implants Types

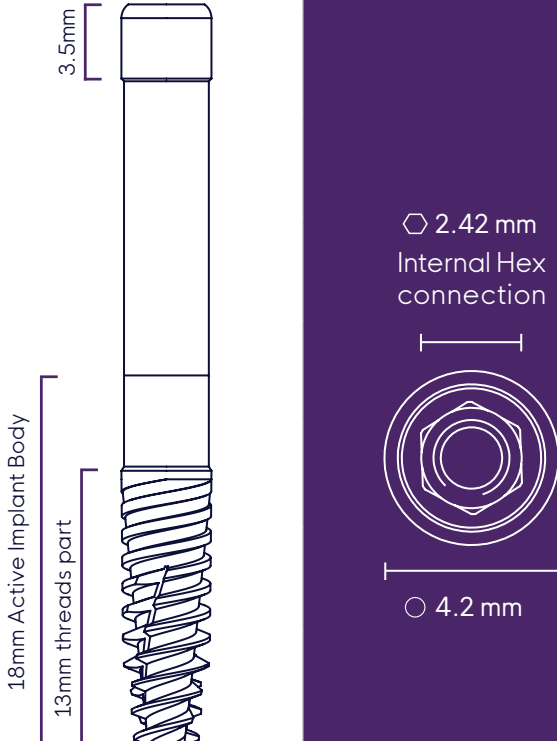
Diameter (Ø) 4.2 mm	Zygoma connection	Lengths	Catalog No.
 <p>3.5mm</p> <p>18mm Active Implant Body</p> <p>13mm threads part</p> <p>2.42 mm Internal Hex connection</p> <p>4.2 mm</p>		35.0mm	ISZT3542
		37.5mm	ISZT3742
		40.0mm	ISZT4042
		42.5mm	ISZT4242
		45.0mm	ISZT4542
		47.5mm	ISZT4742
		50.0mm	ISZT5042
		52.5mm	ISZT5242
		55.0mm	ISZT5542

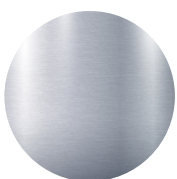

Material:
Titanium grade 23 (Ti 6Al 4V ELI)

Internal Hex connection

Single prosthetic platform for easy restoration

4mm neck

Titanium grade 23 (Ti 6Al 4V ELI)

Smooth machined body

Single platform connection that enables you to keep minimal stock

OsseoFix™ surface

Bone condensing thread profile

Round shaped Apex 3mm

Self-tapping

Double lead threads (2x1.2mm)



Zygomatic

Internal Hex Surgical Kit | ZGSK001





Zygomatic Twist & Pilot Step Drill	Catalog No.
Zygomatic Mark Drill 2.4mmD	DL5524
Zygomatic pilot Drill 1.8/2.5mmD x 35-55mmL	DL5525
Zygomatic twist Step Drill 2.5/3.2mmD x 35-55mmL	DL5532
Zygomatic twist Step Drill 3.2/3.6mmD x 35-55mmL	DL5536

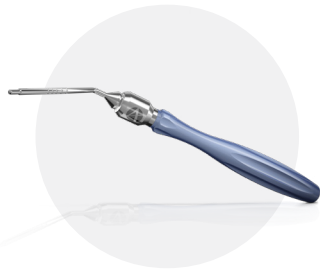

Depth Probe	Catalog No.
Depth Probe, Zygomatic 35-55mm	ZGDP01
Surgical Driver	RS7001



Diamond	Catalog No.
Zygomatic Diamond Burr 4.2mmDx35mmL, Medium	ZGDB3542M
Zygomatic Diamond Burr 4.2mmDx35mmL, Coarse	ZGDB3542C

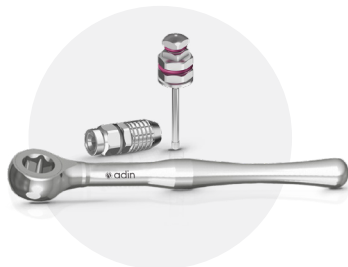

Tools	Catalog No.
Star torque driver-Long	RP0005
RS 2.4 Hex Torque driver-Short	RS6011
RS 2.4 Hex Torque driver-Long	RS6012
RS Hex Handpiece adapter-Long	RS9029
1.27 Hex Torque Driver-Short	RS6080
Wrench Ratchet	RS6100
Wrench Surgical Instruments Handle	RA0050

Drilling Protocol

Drills Intended Use

Adin Touareg™ OS Zygomatic dental drills are bone cutting instruments intended for use in reconstructive oral surgery to drill or cut into the upper jaw and zygomatic bone to prepare the osteotomy for an implant placement.





Mark drill, used to mark the entry point for the pilot drill. Pilot drills (two-step coated drills), used for preparation of initial osteotomy to the desired depth.

Twist step drills (two-step coated drills), used for the gradual preparation of the final osteotomy to the desired diameter, for the placement of dental implant according to bone condition.

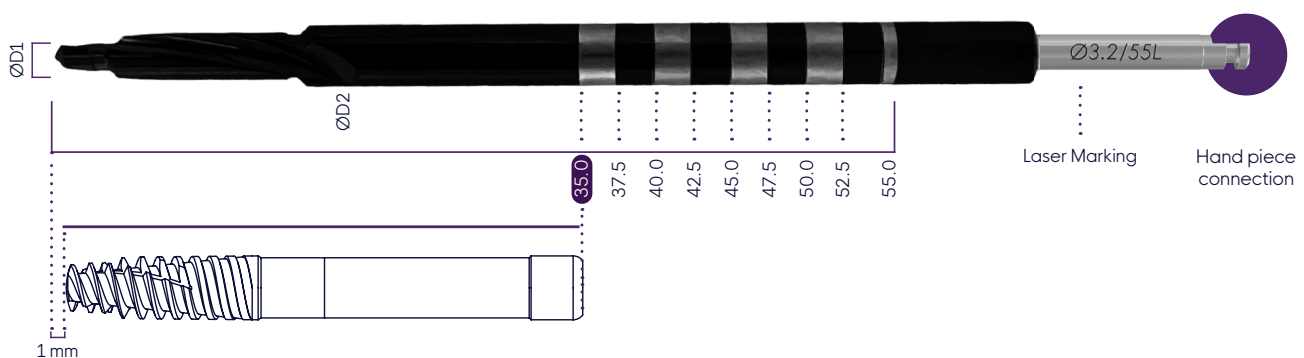
Drills Description and Characteristics

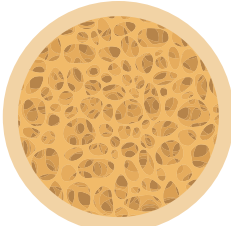
- Adin's drills are made of surgical stainless steel and are used with external irrigation
- Adin's drills are DLC coated to ensure performance
- Drills are available in diameters of $\text{Ø}2.5$, $\text{Ø}3.2$ and $\text{Ø}3.6\text{mm}$
- Drills have depth marks in lengths 35-55mm
- Step drill centered on previous hole
- Laser marking for drill length and diameter
- $\text{Ø}2.4$ spherical Mark drill



Maximum Speed	800-1200	600	600	600
				
	Mark Drill Ø2.4mm	Pilot Drill Ø2.5mm	Twist Drill Ø 3.2mm	Twist Drill Ø 3.6mm

CAUTION: The drill preparation is up to 1mm longer than implant.

Drills



DL5524 Zygomatic Mark Drill 2.4mmD



DL5525 Zygomatic Pilot Drill 1.8/2.5mmD x 35-55mmL



DL5536 Zygomatic Twist Step Drill 3.2/3.6mmD x 35-55mmL

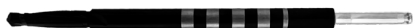

DL5532 Zygomatic Twist Step Drill 2.8/3.2mmD x 35-55mmL

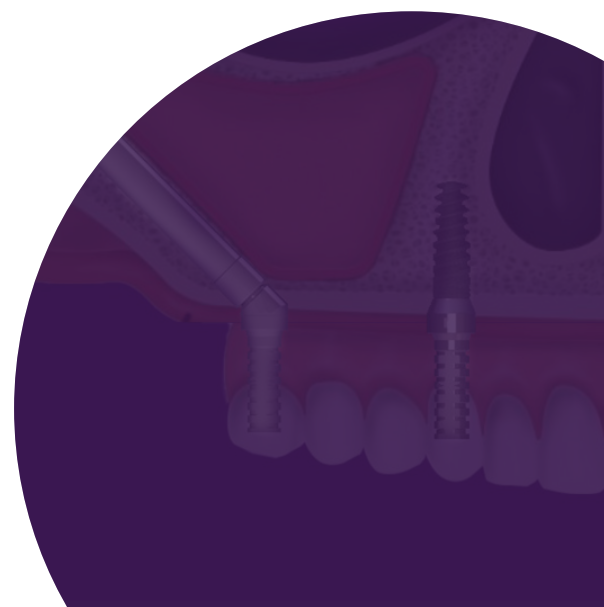

Tools



Star torque driver-Long

RP0005



RS 2.4mm Hex Torque driver-Short

RS6011

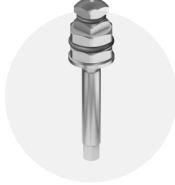

RS 2.4mm Hex Torque driver-Long

RS6012

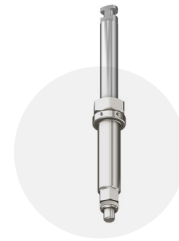

RS Hex Handpiece adapter-Long

RS9029



1.27mm Hex Torque Driver-Short

RS6080



Wrench Ratchet

RS6100



Wrench Ratchet Surgical Instruments Handle

RA0050

TMA™ - Multi Unit

Recommended Torque 35(Ncm)



Our TMA™ (Trans Mucosal Abutment) system is indicated for multiple-unit, screw-retained restorations and may be used in combination with an implant level framework design.



The TMA™ system is used to elevate the restorative seating platform when restoration at implant level is not indicated or practical due to the depth or angle of the implant.

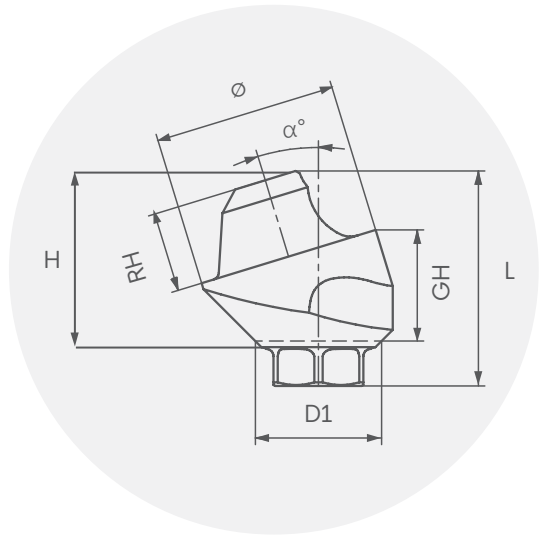

The TMA™ System is designed to allow better prosthetics access when using implants with divergent angles accommodate full and partial edentulous arches, especially when using angled implants and all-on-x technique for full arch restoration.



The TMA™ abutment system is available in straight or angled (17°,30°,45°,52°,60°), engaging the Internal Hex for indexing, with a selection of collar heights. Abutments are delivered with handles for easy insertion and to assist with seating.





TMA		L	Ø	D1	H	GH	RH	Catalog No.
	RS Straight Trans Mucosal Abutment	3.7	4.9	3.4	3.1	1	2.1	RS3731
	RS Straight Trans Mucosal Abutment	4.7	4.9	3.4	4.1	2	2.1	RS3732
	RS Straight Trans Mucosal Abutment	5.7	4.9	3.4	5.1	3	2.1	RS3733
	RS Straight Trans Mucosal Abutment	6.7	4.9	3.4	6.1	4	2.1	RS3729
	RS Straight Trans Mucosal Abutment	7.7	4.9	3.4	7.1	5	2.1	RS3730
	RS Angled Trans Mucosal Abutment 17°	5.17	4.9	3.4	-	2	2.1	RS3734
	RS Angled Trans Mucosal Abutment 17°	6.05	4.9	3.4	-	3	2.1	RS3737
	RS Angled Trans Mucosal Abutment 30°	5.7	4.9	3.4	-	3	2.1	RS3735
	RS Angled Trans Mucosal Abutment 30°	6.5	4.9	3.4	-	4	2.1	RS3738
	RS Angled Trans Mucosal Abutment 45°	5.94	4.9	3.4	-	4	2.1	RS3736
	RS Angled Trans Mucosal Abutment 52°	5.0	4.9	3.4	-	5	2.1	RS3739
	RS Angled Trans Mucosal Abutment 60°	7.5	4.9	3.4	-	5	2.1	RS3740





Transfers		L	∅	D1	D2	H	GH	RH	Catalog No.
	TMA Impression Transfer Open Tray	11	4.9	-	3.1	-	-	-	RS5006
	TMA Impression Transfer Closed Tray	8	4.9	-	4	-	-	-	RS5011

Scan Body		L	∅	D1	D2	H	GH	RH	Catalog No.
	TMA Scan Body	6	4.9	4.9	3.8	4.9	-	-	TM0006
		9	4.9	4.9	3.8	4.9	-	-	TM0009

TMA Abutment		L	∅	D1	D2	H	GH	RH	Catalog No.
	TMA Titanium Temporary Cylinder	12	4.9	-	3.5	-	1.5	10.5	RS4900
	TMA Plastic Casting Sleeve w/Prosthetic Screw	12	4.9	-	3.3	-	1.5	10.5	RS5001
	TMA Cementing Cone	4.9	4.9	-	2.9	-	1.5	3.4	TM0010

TMA Replica		L	∅	D1	D2	H	GH	RH	Catalog No.
	TMA Abutment Replica	16.75	4.9	-	3.6	-	-	-	RS5004
	TMA Digital Model Replica Recommended torque 15(Ncm)	12	4.9	-	3.8	-	-	-	RS1001

Healing Cap		L	Ø	D1	D2	H	GH	RH	Catalog No.
	TMA Healing Cap	5.5	4.9	-	3.5	-	-	-	RS5005
		7.0	4.9	-	3.5	-	-	-	RS5003

Screws		L	Ø	D1	D2	H	GH	RH	Catalog No.
	RS Retaining Screw For Angled TMA	6.1	2.4	-	-	-	-	-	RS3403
	TMA Prosthetic Screw 15(Ncm)	4.1	2.1	-	-	-	-	-	RS3404
	RS Retaining Screw for TMA 1mm	7.8	3.1	-	-	-	-	-	RS3406
	RS Retaining Screw for TMA 2mm	8.8	3.1	-	-	-	-	-	RS3407
	RS Retaining Screw for TMA 3mm	9.8	3.1	-	-	-	-	-	RS3408
	RS Retaining Screw for TMA 4mm	10.8	3.1	-	-	-	-	-	RS3409
	RS Retaining Screw for TMA 5mm	11.8	3.1	-	-	-	-	-	RS3412
	TMA Screw For Open Tray Transfer	14	2.1	-	-	-	-	-	RS5008
	TMA Screw for Closed Tray Transfer	6.8	2.5	-	-	-	-	-	RS5009

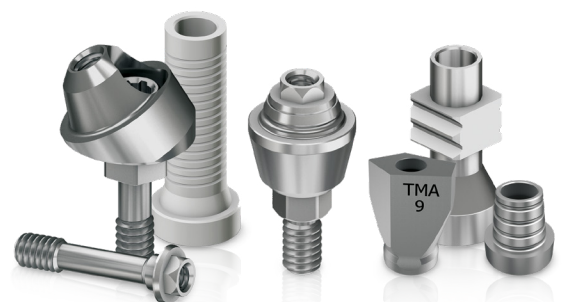

TMA connection drivers



TMA/FC Hex Torque Driver - Long

RS6196

*For straight TMA/Flat connection



TMA/FC Hex Torque Driver - Short

RS6197

*For straight TMA/Flat connection



Star Torque Driver-Long

RP0005

*For Angeld TMA/TMA prosthetic screw



Star Torque Driver-Short

RP0065

*For Angeld TMA/TMA prosthetic screw



TMA/FC Female Hand Hex Driver-Long

RS6191

*For straight TMA/Flat connection

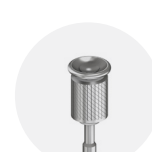

TMA/FC Female Hand Hex Driver-Short

RS6193

*For straight TMA/Flat connection



Star Hand Driver-Long

RP0004

*For Angeld TMA/TMA prosthetic screw



Star Hand Driver-Short

RP0064

*For Angeld TMA/TMA prosthetic screw



TMA/FC Hex Handpiece Adapter-Long

RP0004

*For straight TMA/Flat connection



TMA/FC Hex Handpiece Adapter-Short

RP0064

*For straight TMA/Flat connection



About Adin

Every business starts with a vision.

Ours is simple: We want to create the best possible dental implant solutions that offer uncompromising quality at an affordable price. It's our people that help our business thrive and grow. That's why we place so much importance on building strong personal relationships that enable us to meet our doctors and distributors' needs. Understanding that their success is our success, we're focused on providing professional, high quality and affordable solutions and exceptional service that help them grow.

