

Product Catalog



We are
 adin



Our Mission

To create positive change in the dental implant world by providing quality dental solutions that are accessible to all.

Our Vision

To empower dentists in restoring smiles and enhancing quality of life, with affordable products of superior quality.



Our Values



Accuracy

By committing to innovation, product quality and consistency, and ease of use, we ensure that every rehabilitation challenge is addressed fully and accurately, with the most advanced solutions and tools, and with no compromises.



Accessibility

Behind every product bearing the Adin name, stands an entire team of dental implant experts, laboratory technicians, engineers, Q&A specialists, account executives, and customer support agents. We are all here, just a phone call away, to give you the personal support and attention you deserve, and to guarantee your success.



Accountability

We prioritize patient safety and well-being above all else. Our unwavering accountability for every product we manufacture reflects this commitment. Our devices undergo meticulous testing and quality control measures. We stand behind our devices with a lifetime warranty, ensuring you have access to the support you need throughout the product's lifespan.

Table of Contents

Internal Hex

Touareg™ S/OS.....	8-9
Triple™.....	10-11
Swell™.....	12-13
Cover Screw and Healing Abutments.....	14
Impression.....	15
Temporary and Cement Retained Restoration.....	16
Iris™ Snap-on.....	17
Screw - Retained Restoration Casting Abutments....	18
STMA.....	19-20
CAD/CAM.....	21-24
TMA.....	25-26
Overdenture Restoration.....	27
Grip.....	28-29
Surgical Kits.....	30-33
Drills and Tools.....	34-39
Guided Surgery.....	40-43

UniFit™

UniFit™ Implants.....	46-47
Cover Screw and Healing Abutments.....	48
Impression.....	49
Temporary and Cement Retained Restoration.....	50-51
Screw - Retained Restoration Casting Abutments....	51
Single TMA.....	52-53
CAD/CAM.....	54-57
TMA.....	58-59
Overdenture Restoration.....	60
Grip.....	61-62
Surgical Kits.....	63-65
Drills and Tools.....	66-71
Guided Surgery.....	72-75

CloseFit™ Narrow Implants

Narrow Implants.....	78-80
Cover Screw and Healing Abutments.....	81
Impression.....	82-83
Temporary and Cement Retained Restoration..	83-84
Iris™ Snap-on.....	85-86
Narrow Screw - Retained.....	87
NP Single TMA.....	88-89
CAD/CAM.....	90-94
TMA.....	95-96
Overdenture Restoration.....	97
Grip.....	98-99
Surgical Kits.....	100-103
Drills and Tools.....	104-109
Guided Surgery.....	110-113

CloseFit™ Regular and Wide

Regular and Wide Implants.....	116-118
Cover Screw and Healing Abutments.....	119
Impression.....	120-121
Temporary and Cement Retained Restoration..	121-122
Iris™ Snap-on.....	123-124
Screw - Retained.....	125-126
Single TMA.....	127-128
CAD/CAM.....	129-134
TMA.....	135-136
Overdenture Restoration.....	137
Grip.....	138-139
Surgical Kits.....	140-143
Drills and Tools.....	144-149
Guided Surgery.....	150-153

One™ Implants System

One™ Implants and Analogs.....	154-155
--------------------------------	----------------

Long Implants

Long Implants.....	156-157
Drill Sequence.....	158
Extra Long Drills.....	158

Zygomatic

Zygomatic Implants.....	159-160
Drilling Protocol.....	161
Surgical Kit.....	162-163
TMA.....	164-165

Prosthetic and Stopper Kits

Prosthetic Kit.....	166
Drill Stop Kit- Regular Long.....	168
Drill Stop Kit- Wide Long.....	169
Drill Stop Kit- Regular Short.....	170
Drill Stop Kit- Wide Short.....	171





Internal Hex

Touareg™-S

Triple™



Touareg™-OS

Swell™

Touareg S/OS™

Our most popular implants. Made for simple & streamlined use featuring a high stability mechanism & unique surface treatment with an Internal Hex connection.

Our Touareg™ implants features an active & dynamic self tapping threads, engineered to provide ideal primary stability and immediate loading capabilities in all bone types. Designed for confidence & predictable procedures.

All Touareg™ and restorative parts connect with one unified Internal Hex Connection to simplify management of surgical & prosthetic procedures.

A biocompatible surface treatment that uses gritting with Calcium Phosphate media that is debris free and has been designed to achieve the desired roughness levels needed for optimal osseointegration.

Provides roughened micro and nano-structure surface topography. This structure leads to optimal cell adherence and proliferation in the cavities of the roughened implant surface, significantly increasing the number of cells attached to the surface and is associated with a shorter healing time.

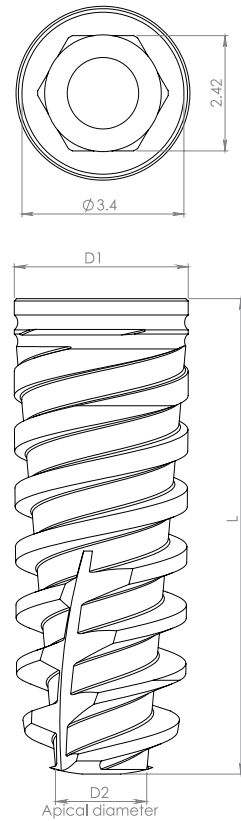

Single restoration system to simplify management of surgical & prosthetic components

Designed to provide high primary stability in all bone types

Built-in platform switching

Redirecting capability for optimal placement

Implant diameter
Ø 3.5-6mmD

Micro Threads:
Engineered to minimize bone loss & increase bone implant contact

Immediate function capability

Minimally invasive surgery

Self tapping

AB/AE
Touareg-S™

Double lead threads
2.4mm(2×1.2mm)
For fast & efficient insertion

Round apex

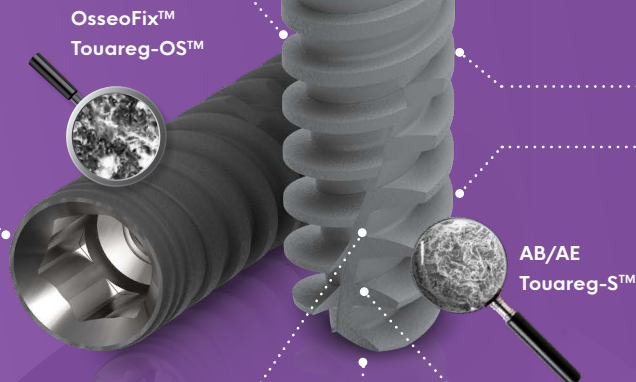

Touareg S™

Recommended insertion torque up to 50 Ncm

	D1	L	D2	Catalog No.
	3.5	8.0	1.9	ISPS0835
		10.0	1.9	ISPS1035
		11.5	1.5	ISPS1135
		13.0	1.5	ISPS1335
		16.0	1.5	ISPS1635
		18.0	1.5	ISPS1835
	3.75	8.0	1.6	ISPS0838
		10.0	1.6	ISPS1038
		11.5	1.6	ISPS1138
		13.0	1.6	ISPS1338
		16.0	1.6	ISPS1638
		18.0	1.6	ISPS1838
	4.2	6.25	2.0	ISPS0642
		8.0	2.0	ISPS0842
		10.0	2.0	ISPS1042
		11.5	2.0	ISPS1142
		13.0	2.0	ISPS1342
		16.0	1.9	ISPS1642
		18.0	1.9	ISPS1842
	5.0	6.25	2.5	ISPS0650
		8.0	2.5	ISPS0850
		10.0	2.5	ISPS1050
		11.5	2.5	ISPS1150
		13.0	2.5	ISPS1350
		16.0	2.5	ISPS1650
	6.0	6.25	3.5	ISPS0660
		8.0	3.5	ISPS0860
		10.0	3.5	ISPS1060
		11.5	3.5	ISPS1160
		13.0	3.5	ISPS1360

Radiographic Template Touareg S™ | ASD0610

Touareg OS™

Recommended insertion torque up to 50 Ncm

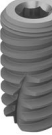
	D1	L	D2	Catalog No.
	3.5	8.0	1.9	ISF0835
		10.0	1.9	ISF1035
		11.5	1.5	ISF1135
		13.0	1.5	ISF1335
		16.0	1.5	ISF1635
		18.0	1.5	ISF1835
	3.75	8.0	1.6	ISF0838
		10.0	1.6	ISF1038
		11.5	1.6	ISF1138
		13.0	1.6	ISF1338
		16.0	1.6	ISF1638
		18.0	1.6	ISF1838
	4.2	6.25	2.0	ISF0642
		8.0	2.0	ISF0842
		10.0	2.0	ISF1042
		11.5	2.0	ISF1142
		13.0	2.0	ISF1342
		16.0	1.9	ISF1642
		18.0	1.9	ISF1842
	5.0	6.25	2.5	ISF0650
		8.0	2.5	ISF0850
		10.0	2.5	ISF1050
		11.5	2.5	ISF1150
		13.0	2.5	ISF1350
		16.0	2.5	ISF1650
	6.0	6.25	3.5	ISF0660
		8.0	3.5	ISF0860
		10.0	3.5	ISF1060
		11.5	3.5	ISF1160
		13.0	3.5	ISF1360

Radiographic Template Touareg OS™ | ASD0610

Triple™

Triple is a unique triple spiral trapezoid thread dental implant. With vertical cutting channels that run the full length of the implant it offers three main advantages

- Insertion speed
- Ease of installation and restoration
- High instantaneous stability

The Triple has three vertical channels from the neck of the implant to the bottom for improved balance of power transfer to the bone.

The unique external thread, with three starts and a step of 3.6 mm (3×1.2 mm), for bone cutting. Easier and smoother and faster to insert than any other implant in the category.

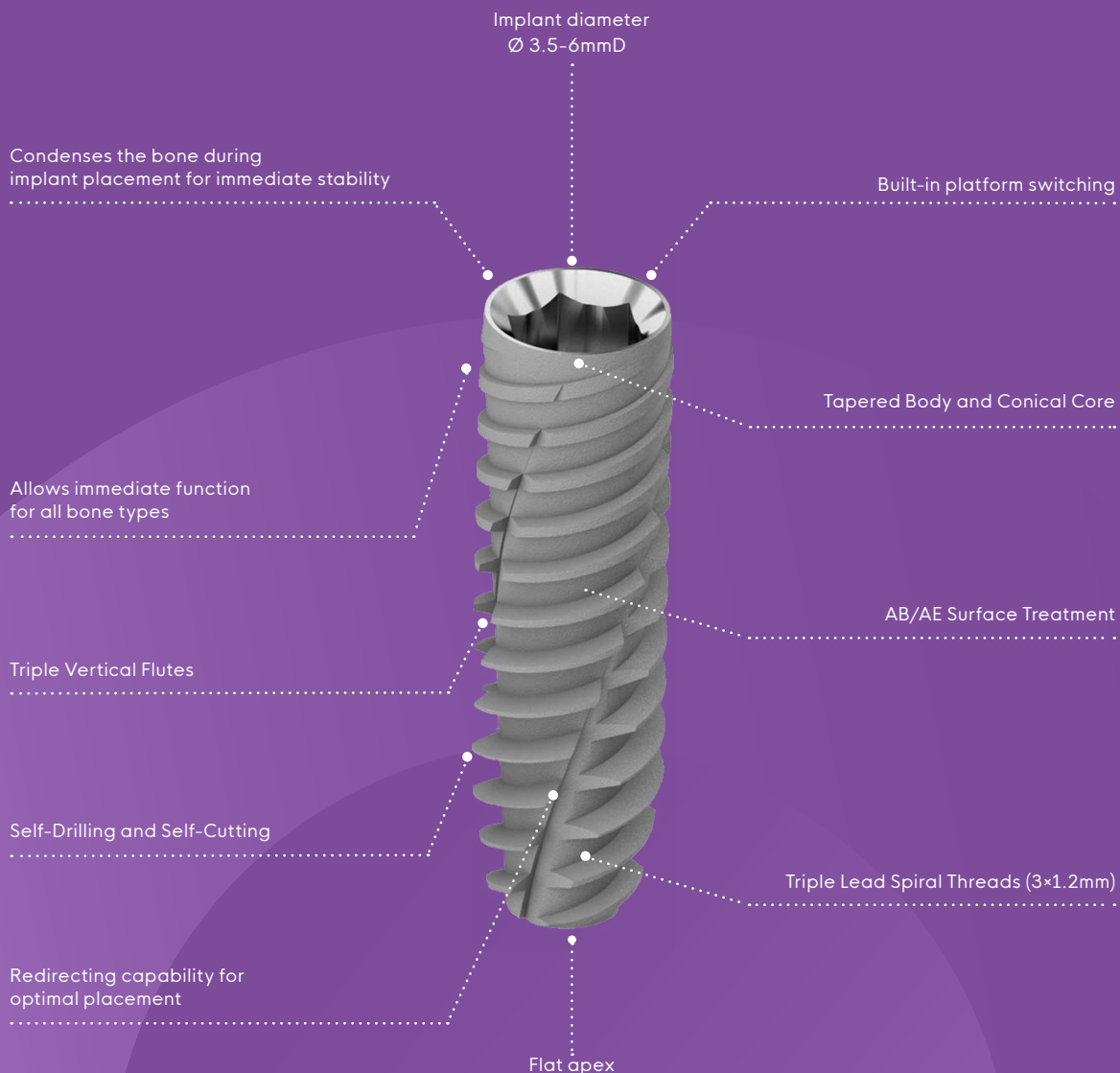
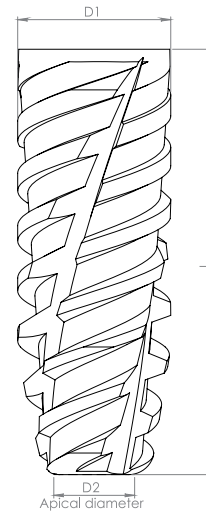
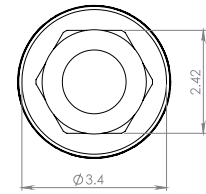

Recommended insertion torque up to 50 Ncm

	D1	L	D2	Catalog No.		D1	L	D2	Catalog No.
	3.5	8.0	2.2	IST0835		4.2	6.25	2.7	IST0642
		10.0	2.2	IST1035			8.0	2.7	IST0842
		11.5	2.2	IST1135			10.0	2.7	IST1042
		13.0	2.2	IST1335			11.5	2.7	IST1142
		16.0	2.2	IST1635			13.0	2.7	IST1342
		18.0	2.0	IST1835			16.0	2.7	IST1642
	3.75	8.0	2.3	IST0838		5.0	6.25	3.3	IST0650
		10.0	2.3	IST1038			8.0	3.3	IST0850
		11.5	2.3	IST1138			10.0	3.3	IST1050
		13.0	2.3	IST1338			11.5	3.3	IST1150
		16.0	2.3	IST1638	13.0	3.3	IST1350		
		18.0	2.3	IST1838		6.0	6.25	4.2	IST0660
			8.0	4.2			IST0860		
			10.0	4.2			IST1060		
			11.5	4.2			IST1160		
						13.0	4.2	IST1360	
						16.0	4.2	IST1660	

Radiographic Template Triple™ | ASD0616

Drill Sequence for Toureg S/OS™ & Triple™ Recommended drilling speed up to 1200 rpm

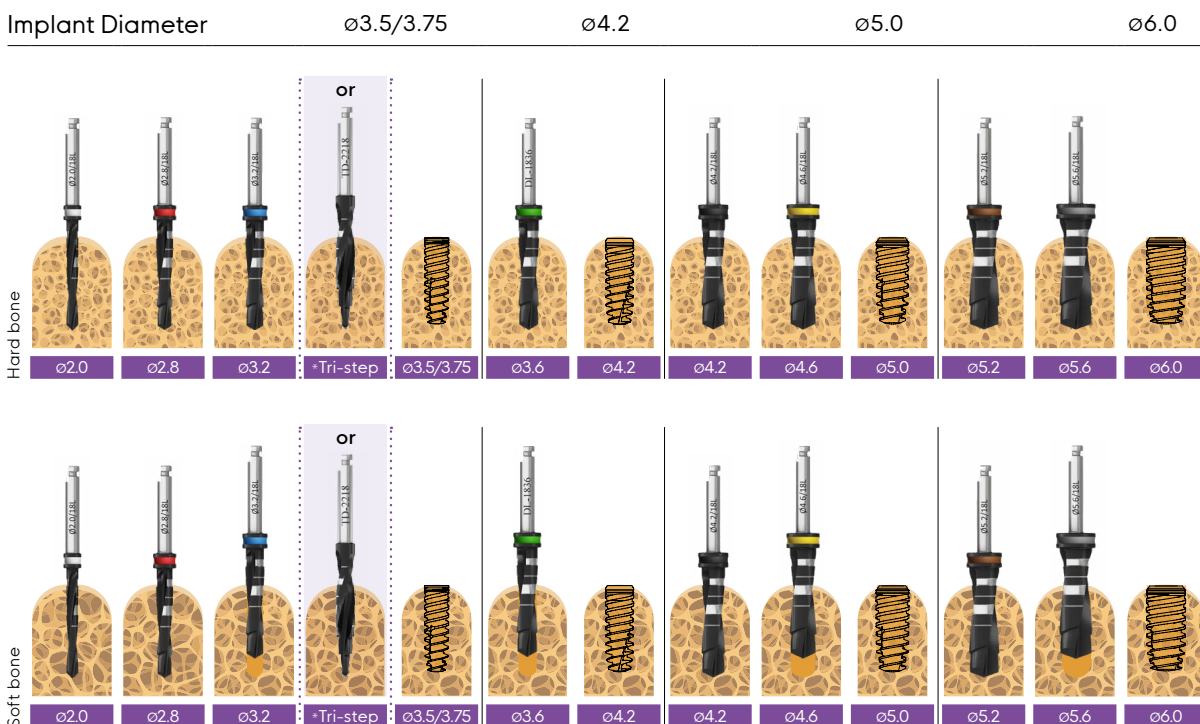

All measurements are in mm.

*For initial drilling, you may use Tri-step drill instead of $\varnothing 2$, $\varnothing 2.8$ and $\varnothing 3.2$ drills in sequence.

Note: (x.xx) Drill to the depth of the cortex only. All measurements are in mm.

⚠ CAUTION: The drill preparation is up to 1mm longer than the implant. * The drill apical step = 1.8mmD

Swell™

The Swell™ - A hybrid implant with a parallel body, tapered apex and a V-shaped thread design. Its' design allows for accurate positioning, improved aesthetics and better load distribution. Recommended for use in the mandibular arch.

The Swell™ implant features Alumina Oxide Blasted/Acid Etched (AB/AE) surface treatment.

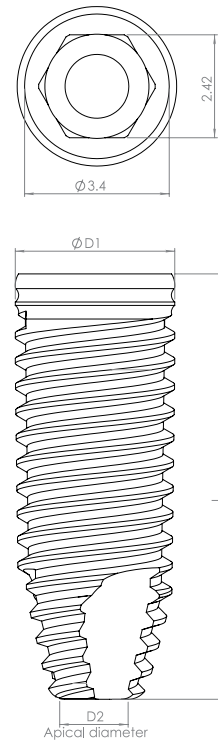

Accurate positioning, improved aesthetics and better load distribution

Immediate function capability

V-Shape thread design

Self tapping

Redirecting capability for optimal placement

Implant diameter
Ø 3.3-6mmD



Micro Threads:
Engineered to enhance bone regeneration, prevent bone loss & increase bone implant contact

Parallel Body

Double Lead Threads
(2X0.6mm) for Fast, Efficient Insertion

Tapered apex

	D1	L	D2	Catalog No.
	3.3	10.0	2.2	ID1033
		11.5	2.2	ID1133
		13.0	2.2	ID1333
		16.0	2.2	ID1633
		18.0	2.2	ID1833
	3.75	8.0	2.0	ID0838
		10.0	2.0	ID1038
		11.5	2.0	ID1138
		13.0	2.0	ID1338
		16.0	2.0	ID1638
	18.0	2.0	ID1838	

	D1	L	D2	Catalog No.
	4.2	6.25	2.6	ID0642
		8.0	2.6	ID0842
		10.0	2.6	ID1042
		11.5	2.6	ID1142
		13.0	2.6	ID1342
		16.0	2.6	ID1642
	18.0	2.6	ID1842	
	5.0	6.2	3.4	ID0650
		8.0	3.4	ID0850
		10.0	3.4	ID1050
		11.5	3.4	ID1150
		13.0	3.4	ID1350
		16.0	3.4	ID1650
	6.0	6.2	4.4	ID0660
		8.0	4.4	ID0860
		10.0	4.4	ID1060
		11.5	4.4	ID1160
		13.0	4.4	ID1360

Radiographic Template Swell™ | ASD0613

Drill Sequence for Swell™ Recommended drilling speed up to 1200 rpm

Implant Diameter $\varnothing 3.3$

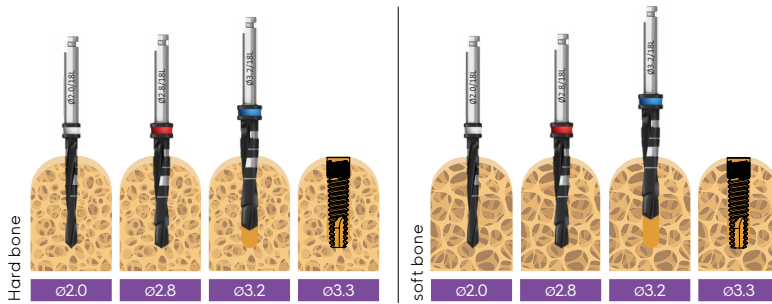

Implant Diameter $\varnothing 3.75$ $\varnothing 4.2$ $\varnothing 5.0$ $\varnothing 6.0$

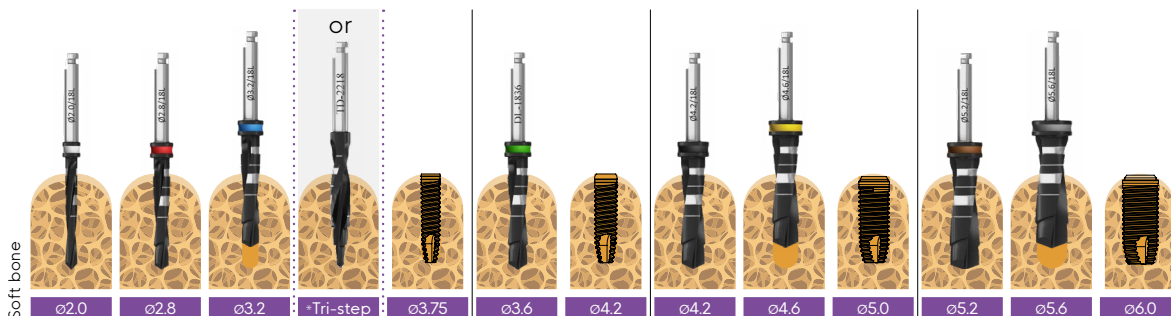
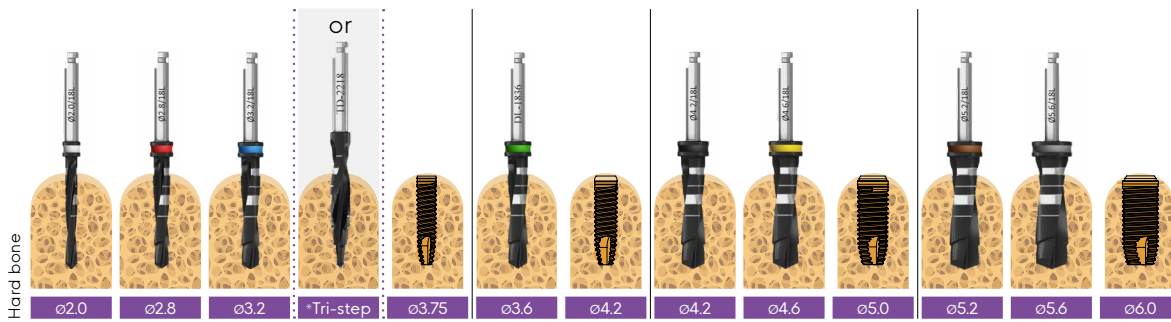

All measurements are in mm.

*For initial drilling, you may use Tri-step drill instead of $\varnothing 2$, $\varnothing 2.8$ and $\varnothing 3.2$ drills in sequence.

Note: (x.xx) Drill to the depth of the cortex only. All measurements are in mm.



⚠ CAUTION: The drill preparation is up to 1mm longer than the implant. * The drill apical step = 1.8mmD

Cover Screw & Healing Abutments





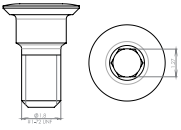

Recommended Torque 15(Ncm)

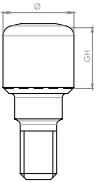

Cover Screw Packed with implant

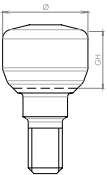
		Description	Catalog No.
		Cover Screw	RS3435

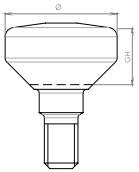
Healing Abutments

		Description	GH	Ø	Catalog No.
		RS Slim Healing Abutment	2.0	3.5	RS3027
			3.0	3.5	RS3028
			4.0	3.5	RS3029
			5.0	3.5	RS3030
			6.0	3.5	RS3031
			7.0	3.5	RS3040
		RS Healing Abutment	2.0	4.5	RS3022
			3.0	4.5	RS3023
			4.0	4.5	RS3024
			5.0	4.5	RS3025
			6.0	4.5	RS3026
			7.0	4.5	RS3042
		RS Wide Healing Abutment	2.0	6.0	RS3012
			3.0	6.0	RS3013
			4.0	6.0	RS3014
			5.0	6.0	RS3015
			6.0	6.0	RS3016
			7.0	6.0	RS3017

Impression

Recommended Torque 15(Ncm)

Our components for taking impressions for all restoration types can be successfully utilized for digital or conventional protocols either implant-level or abutment level procedures.

Our broad range of solutions and flexible designs enable easy and accurate restorative planning, whether you're dealing with a single tooth, multiple teeth, bridge or full mouth rehabilitation.



Transfers | Recommended Torque 15(Ncm)

		RS Open Tray Transfer Short	20.0	6.0	12.4	RS3513
		RS Open Tray Transfer Long	24.0	6.0	15.4	RS3517

	Close Tray	Description	L	D1	H	Catalog No.
		RS Close Tray Transfer Short	11.0	4.6	9.0	RS5111
		RS Close Tray Transfer Long	15.0	4.6	13.0	RS5115

	Description	H	Catalog No.		Description	H	Catalog No.
	RS Scan Body	7.0	RS0088		RS Scan Body	10.0	RS0089









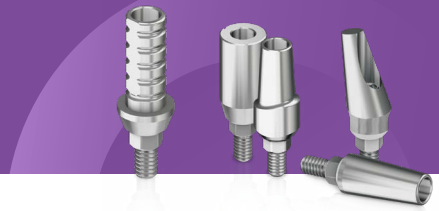





Analogs

	Description	L	D1	Catalog No.		Description	Catalog No.		Description	L	D1	Catalog No.
	RS Digital Model Analog	10.0	3.75	RS1000		Retaining Screw	RS1002		RS Internal Hex Implant Analog	12.6	3.75	RS5737

Temporary & Cement Retained Restoration

Recommended Torque 35(Ncm)



	Description	D1	GH	RH	Catalog No.
	RS Engaging Straight Cylindrical Titanium Abutment	4.5	2	7.9	RS3411
	RS Non-Engaging Straight Cylindrical Titanium Abutment	4.5	2	7.9	RS3422
	RS Esthetic Straight Abutments	4.5	1	6.5	RS0010
		4.5	2	6.5	RS0011
		4.5	3	6.5	RS0012
	RS Straight Titanium Abutment - No End Line	4.5	1	7.5	RS3800
	RS Titanium Straight Abutments	4.5	1	7.7	RS3801
		4.5	2	7.7	RS3802
		4.5	3	7.7	RS3803
		4.5	4	7.7	RS3804
		4.5	5	7.7	RS3805
	RS Straight Titanium Abutment Long	4.5	1.3	11	RS3811
	RS One Piece Screw-In Abutment	4.5	1.5	9.3	RS3812
	RS Slim Titanium Abutments	3.9	0.85	2.8	RS3903
		3.9	0.85	5.4	RS3906
		3.9	0.85	7.9	RS3908
	RS Titanium Abutment 5.0 mmD Wide	5.0	2.2	7.4	RS3950
	RS Angled Titanium Abutments 15°	4.7	1.6	7.2	RS4015
		4.68	1.5	10	RS4016
	RS Slim Angled Abutments 15° - No End Line	3.8	1	7.4	RS4017
		3.8	2	7.4	RS4018
		3.8	3	7.4	RS4019
	RS Esthetic Angled Titanium Abutments 15°	4.6	1	7.3	RS4115
		4.6	2	7.3	RS4117
		4.6	3	7.3	RS4119
	RS Angled Titanium Abutment 25°	4.7	2	7	RS4025
	RS Angled Titanium Abutment 35°	4.9	2	8	RS4035

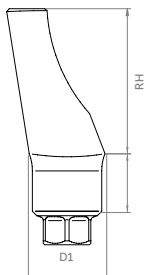

Iris™ Snap - on for Touareg S/OS™

Adin's Snap-on impression is an effective and easy option for both implant level and abutment level impression copying. Plastic pickup cap placed over a precision machined abutment allows for accurate coping utilizing closed tray impression.

Adin's Snap-on range aims to allow flexibility by offering various options to match users preferred method of use through pre packed kits:

- IRIS™ Kit - abutment level impression and restoration set
- Snap-on impression kit - implant level impression

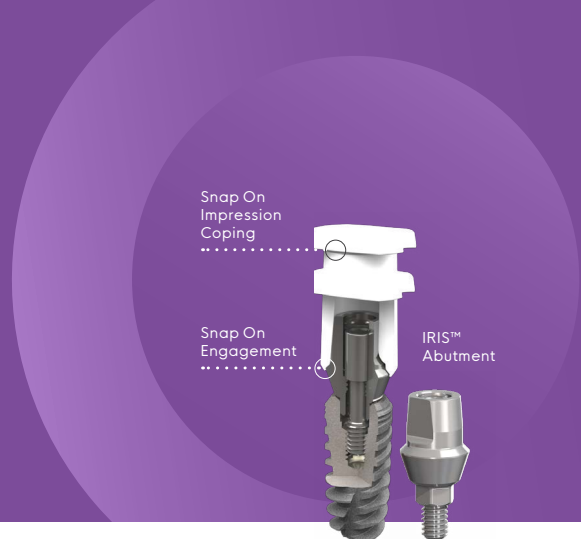

Iris™ Kit



Description	RH	GH	Catalog No.
Iris™ RS Kits	4	1	IR4041
		2	IR4042
		3	IR4043
		4	IR4044
	6	1	IR4061
		2	IR4062
		3	IR4063
		4	IR4064
	8	1	IR4081
		2	IR4082
		3	IR4083
		4	IR4084

Description	RH	GH	Catalog No.
Iris™ RS Snap-on Impression Kit	4	1	IR4141
		2	IR4142
		3	IR4143
		4	IR4144
	6	2	IR4262
		4	IR4264

- Abutment | Snap-on impression cap | Implant analog

Description	RH	GH	Catalog No.
Iris™ RS Abutment	4	1	IR0441
		2	IR0442
		3	IR0443
		4	IR0444
	6	1	IR0461
		2	IR0462
		3	IR0463
		4	IR0464
	8	1	IR0481
		2	IR0482
		3	IR0483
		4	IR0484

- Abutment | Snap-on impression cap | Implant analog

- Abutment | Snap-on cap | Anti-rotation burnout sleeve (red)
- Free-rotation burnout sleeve (White)
- Patient comfort cap | Abutment level replica

Description	RH	Catalog No.
Implant Analog	-	RS5737
Iris™ Abutment replica	4	IR0404
	6	IR0406
	8	IR0408
Iris™ PEEK Comfort cap	4	IR0180
	6	IR0181
	8	IR0189

Description	Qty	Catalog No.
Iris™, Burnout anti rotation cap red	1	IR0182
	4	IR0185
Iris™, Burnout cap white	4	IR0183
	6	IR0186
	1	IR0179
Iris™, Impression coping	4	IR0184

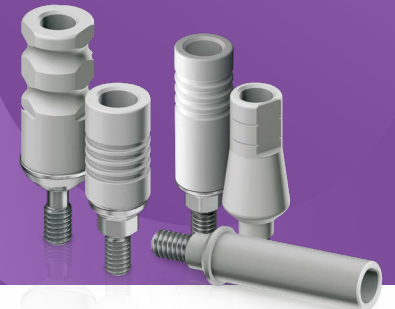

		Description	D1	GH	RH	Catalog No.
		RS Engaging Gold/Plastic Abutment	3.9	0.5	10	RS3090
		RS Engaging Plastic Casting Standard Abutment	4.5	0.8	7.9	RS5010
		RS Engaging Plastic Cylinder Casting Abutment	3.9	0.6	10.8	RS5000
		RS Non-Engaging Plastic Cylinder Casting Abutment	3.9	0.6	10.8	RS5020
		RS Engaging Plastic Standard Abutment	4.5	2.0	6.9	RS5030
		RS Engaging Plastic Cylinder Abutment	4.5	2.0	7.9	RS5040
		RS Non-Engaging Plastic Standard Abutment	4.5	2.0	7.9	RS5050
		RS Engaging Cobalt Chrome/Plastic Abutment	3.9	0.5	10.0	RS3094
		RS Engaging Titanium/Plastic Abutment	4.9	1.4	10.0	RS3095
		RS Non-Engaging Cobalt Chrome/Plastic Abutment	3.9	0.5	10.0	RS3100
RS Non-Engaging Titanium/Plastic Abutment		4.9	1.4	9.6	RS3097	

Prosthetic	Catalog No.	Open Tray	Catalog No.	Close Tray	Catalog No.
	RS3400		RS3428		RS5126
	RS3402				RS5127
	RS3480		RS3429		

STMA™ Recommended Torque 35(Ncm)

Adin's STMA screw-retained restoration system leverages the exceptional flexibility of TMA abutments, making it ideal for both multi-unit bridges and full-arch restorations. This versatile system ensures precise and adaptable outcomes by combining the security of screw retention with the advantages of a trans-gingival approach, enhancing aesthetics, safety, and ease of maintenance. The STMA's recommended torque is 35 Ncm.

Its concave design promotes a thick mucosal seal around the trans-gingival connection, resulting in a natural, metal-free appearance and an optimized emergence profile. Complemented by golden anodization that minimizes tissue transparency and metal visibility for a truly harmonious look.

Perfect for complex cases, including divergent implant angles, while offering straight and angled (17°, 30°) options.

The concave abutment design encourages a healthy peri-implant environment and natural soft tissue contours.

The elevated platform simplifies restorative seating when implant-level restorations are challenging.

Abutments are delivered with handles for effortless insertion and secure seating.

Compatible with open and closed tray impression techniques, as well as scan bodies for seamless digital workflows and replicas.



Available in a variety of gingival heights to achieve optimal aesthetic results in diverse clinical situations.

		Description	GH	Catalog No.
		RS Straight Single TMA 1mm	1.0	RS3731S
		RS Straight Single TMA 2mm	2.0	RS3732S
		RS Straight Single TMA 3mm	3.0	RS3733S
		RS Straight Single TMA 4mm	4.0	RS3729S
		RS Straight Single TMA 5mm	5.0	RS3730S
		RS Angled Single TMA 17° 2mm	2.0	RS3734S
		RS Angled Single TMA 30° 3mm	3.0	RS3735S
		RS Angled Single TMA 17° 3mm	3.0	RS3737S
		RS Angled Single TMA 30° 4mm	4.0	RS3738S

Transfers

	Single TMA Impression Coping Open Tray	11.0	4.9	3.1	RS5006S		Single TMA Closed Tray Transfer	8.0	4.9	4.1	RS5011S
---	--	------	-----	-----	---------	---	---------------------------------	-----	-----	-----	---------

Snap-On

	Single TMA Snap-On Transfer	RH	D1	D2	Catalog No.		IRIS™, Impression coping				
		8.0	4.9	3.2	RS5012S			10	5.5	7.5	IR0179

	Single TMA Abutment Replica	L	D1	Catalog No.		Single TMA Digital Model Replica Recommended torque 15(Ncm)	L	D1	Catalog No.
		14.6	4.9	RS5004S			9.0	4.9	RS1001S

Scan Bodies





	Description	L	D1	Catalog No.
	Single TMA Scan Body	6.0	4.9	TM0006S
		9.0	4.9	TM0009S

STMA Screw For Scan Body & Cementing Cone



	Description	Catalog No.
	TMA Scan Body Screw	TM0001



STMA Screw Temporary Cylinder & STMA Direct Option

	Description	Catalog No.
	TMA Prosthetic Screw	RS3404

	Description	L	D1	D2	H	Catalog No.
	Single TMA Titanium Temporary	12.0	4.9	3.5	10.5	RS4900S
	Single TMA Plastic Casting Sleeve w/Prosthetic Screw	12.0	4.9	3.3	10.5	RS5001S
	Single TMA Healing Cup	5.5	4.9	3.5	-	RS5005S
	Single TMA Cementing Cone, low profile	4.9	5.5	3.2	-	TM0011S

Tool Drivers | For Angled TMA/TMA Prosthetic Screws

	For Angled TMA/TMA prosthetic screw	L	Catalog No.
	Star Hand Driver Short	23.4	RP0064
	Star Hand Driver Long	28.4	RP0004
	Star Torque Driver-Short	20.4	RP0065
	Star Torque Driver-Long	25.4	RP0005



	For straight TMA	L	Catalog No.
	TMA/FC Hex Torque Driver - Short	20	RS6197
	TMA/FC Hex Torque Driver - Long	25	RS6196
	TMA/FC Female Hand Hex Driver-Short	22.4	RS6193
	TMA/FC Female Hand Hex Driver-Long	28.4	RS6191
	TMA/FC Hex Handpiece Adapter-Short	20	RS6194
	TMA/FC Hex Handpiece Adapter-Long	25	RS6195A









Adin's CAD - CAM components and digital libraries enable clinicians and technicians to design and manufacture state-of-the-art restorations supported by Adin's implants, using current digital restoration processes.

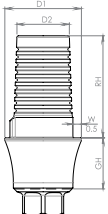

The variety of components ensures endless restorative options for treatment of single, multiple, partially, or fully edentulous cases.

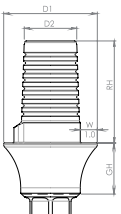

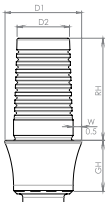
For Intra-oral and Desktop Scanner		H	Catalog No.	For Medentika Preface® Holder		Ø	Catalog No.
	RS Scan Body	7	RS0088		Ti Blank	11.5	RS1411
		10	RS0089			15.8	RS1415



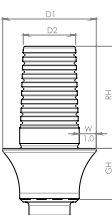



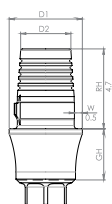

Ti Base Abutments | Recommended Torque 35(Ncm)

	Description	RH	GH	D1	D2	Catalog No.
	 Ti Base RS Abutment, Engaged	4.0	1.0	4.5	3.2	TB04411
		4.0	2.0	4.5	3.2	TB04421
		4.0	3.0	4.5	3.2	TB04431
		4.0	4.0	4.5	3.2	TB04441
		6.0	1.0	4.5	3.1	TB04611
		6.0	2.0	4.5	3.1	TB04621
		6.0	3.0	4.5	3.1	TB04631
		6.0	4.0	4.5	3.1	TB04641
		8.0	1.0	4.5	2.9	TB04811
		8.0	2.0	4.5	2.9	TB04821
		8.0	3.0	4.5	2.9	TB04831
		8.0	4.0	4.5	2.9	TB04841
	 Ti Base RS Abutment, Engaged Wide	4.0	1.0	5.5	3.2	TB04411W
		4.0	2.0	5.5	3.2	TB04421W
		4.0	3.0	5.5	3.2	TB04431W
		4.0	4.0	5.5	3.2	TB04441W
		6.0	1.0	5.5	3.1	TB04611W
		6.0	2.0	5.5	3.1	TB04621W
		6.0	3.0	5.5	3.1	TB04631W
		6.0	4.0	5.5	3.1	TB04641W
		8.0	1.0	5.5	2.9	TB04811W
		8.0	2.0	5.5	2.9	TB04821W
		8.0	3.0	5.5	2.9	TB04831W
		8.0	4.0	5.5	2.9	TB04841W
	 Ti Base RS Abutment, Non Engaged	4.0	1.0	4.5	3.2	TB04412
		4.0	2.0	4.5	3.2	TB04422
		4.0	3.0	4.5	3.2	TB04432
		4.0	4.0	4.5	3.2	TB04442
		6.0	1.0	4.5	3.1	TB04612
		6.0	2.0	4.5	3.1	TB04622
		6.0	3.0	4.5	3.1	TB04632
		6.0	4.0	4.5	3.1	TB04642
		8.0	1.0	4.5	2.9	TB04812
		8.0	2.0	4.5	2.9	TB04822
		8.0	3.0	4.5	2.9	TB04832
		8.0	4.0	4.5	2.9	TB04842

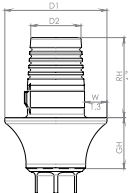
		RH	GH	D1	D2	Catalog No.
	 Ti Base RS Abutment, Non-Engaged Wide	4.0	1.0	5.5	3.2	TB04412W
		4.0	2.0	5.5	3.2	TB04422W
		4.0	3.0	5.5	3.2	TB04432W
		4.0	4.0	5.5	3.2	TB04442W
		6.0	1.0	5.5	3.1	TB04612W
		6.0	2.0	5.5	3.1	TB04622W
		6.0	3.0	5.5	3.1	TB04632W
		6.0	4.0	5.5	3.1	TB04642W
		8.0	1.0	5.5	2.9	TB04812W
		8.0	2.0	5.5	2.9	TB04822W
		8.0	3.0	5.5	2.9	TB04832W
		8.0	4.0	5.5	2.9	TB04842W

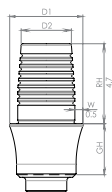
C-Type Ti Base Abutments | Recommended Torque 35(Ncm)

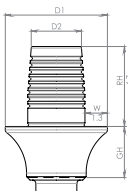
For further product information and use please refer to IFU028

	Description	RH	GH	D1	D2	Catalog No.
	 C-Type Ti Base RS Abutment, Engaged	4.7	1.0	4.3	2.9	TB04414
		4.7	2.0	4.3	2.9	TB04424
		4.7	3.0	4.3	2.9	TB04434
		4.7	4.0	4.3	2.9	TB04444
	 C-Type Ti Base RS Abutment, Engaged Wide	4.7	1.0	6.0	2.9	TB04414W
		4.7	2.0	6.0	2.9	TB04424W
		4.7	3.0	6.0	2.9	TB04434W
		4.7	4.0	6.0	2.9	TB04444W
	 Ti Base RS Abutment, Non Engaged	4.7	1.0	4.3	2.9	TB04415
		4.7	2.0	4.3	2.9	TB04425
		4.7	3.0	4.3	2.9	TB04435
		4.7	4.0	4.3	2.9	TB04445
	 Ti Base RS Abutment, Non Engaged Wide	4.7	1.0	6.0	2.9	TB04415W
		4.7	2.0	6.0	2.9	TB04425W
		4.7	3.0	6.0	2.9	TB04435W
		4.7	4.0	6.0	2.9	TB04445W



CAD CAM | Angulated Screw Channel



The angulated screw channel (ASC) solution offers a transformative approach to dental restorations. ASC strategically places a screw access hole at an angle within the prosthesis, optimizing both function and esthetics.

By integrating digital planning and specialized drivers, ASC enhances accuracy and predictability in implant-supported restorations. This approach signifies a significant advancement in dental care, prioritizing esthetics and functionality to ensure patient satisfaction.

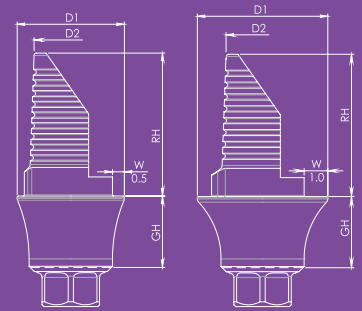
Adin's angulated screw channel Ti bases support gingival heights of 1-3mm for every each implant platform and allow for angulation of up to 20 degrees.





Ti Base Abutment Angular

	RH	GH	D1	D2	Catalog No.		RH	GH	D1	D2	Catalog No.
 <p>Ti Base Abutment Angular Engaged</p>	4.0	1.0	4.5	3.2	TB04413	 <p>Ti Base Abutment Angular Engaged Wide</p>	4.0	1.0	5.5	3.2	TB04413W
	4.0	2.0	4.5	3.2	TB04423		4.0	2.0	5.5	3.2	TB04423W
	4.0	3.0	4.5	3.2	TB04433		4.0	3.0	5.5	3.2	TB04433W
	6.0	1.0	4.5	3.1	TB04613		6.0	1.0	5.5	3.1	TB04613W
	6.0	2.0	4.5	3.1	TB04623		6.0	2.0	5.5	3.1	TB04623W
	6.0	3.0	4.5	3.1	TB04633		6.0	3.0	5.5	3.1	TB04633W
	8.0	1.0	4.5	2.9	TB04813		8.0	1.0	5.5	2.9	TB04813W
	8.0	2.0	4.5	2.9	TB04823		8.0	2.0	5.5	2.9	TB04823W
	8.0	3.0	4.5	2.9	TB04833		8.0	3.0	5.5	2.9	TB04833W
	Abutments are supplied with RS3405 screw. Recommended torque 30-35Ncm. Also available separately.										RS3405

Angulated Tools

	Description	L	L2	D1	D2	Catalog No.
	Angulated Screw Extractor Hand Driver	24.7	10	1.4	9.4	RP6400
	Angulated Star Screw Hand Driver - Short 23.4L	23.4	9.0	1.4	9.4	RP6401
	Angulated Star Screw Hand Driver - Long 28.4L	28.4	14.0	1.4	9.4	RP6402
	Angulated Star Screw Torque Driver - Short 17.0L	17.0	11.0	1.4	7.0	RP6403
	Angulated Star Screw Torque Driver - Long 22.0L	22.0	16.0	1.4	7.0	RP6404
	Angulated Star Screw Handpiece Driver - Extra Short 20.0L	20.0	7.0	1.4	2.35	RP6405
	Angulated Star Screw Handpiece Driver - Short 25.0L	25.0	12.0	1.4	2.35	RP6406
	Angulated Star Screw Handpiece Driver - Long 30.0L	30.0	17.0	1.4	2.35	RP6407



Digital Analogs

	Description	L	D1	Catalog No.		Description	Catalog No.		Description	L	D1	D2	Catalog No.
	RS Digital Model Analog	10.0	3.75	RS1000		Retaining Screw	RS1002		TMA Digital Model Replica Recommended torque 15(Ncm)	12.0	4.9	3.8	RS1001



Screws

	Description	Catalog No.
	Prosthetic Screw For Scan Body 7mm	RS3400
	Screw for Closed Tray Transfer For Scan Body 10mm	RS3425
	Short Prosthetic Screw For Ti Bases & Ti Blanks	RS3402





TMA - Multi Unit Screws

	Description	Catalog No.
	TMA Scan Body Screw	TM0001
	TMA Prosthetic Screw	RS3404

| For Intra-oral and Desktop Scanner

	Description	L	D1	Catalog No.		Description	L	D1	Catalog No.
	Single TMA Scan Body	6.0	4.9	TM0006S		TMA Scan Body	6.0	4.9	TM0006
		9.0	4.9	TM0009S			9.0	4.9	TM0009

STMA / TMA Cementing Cone & Temporary Cylinder

	Description	L	D1	D2	Catalog No.		Description	L	D1	D2	Catalog No.
	Single TMA Titanium Temporary	12.0	4.9	3.5	10.5	RS4900S		4.9	5.5	3.2	TM0011S
	TMA Titanium Temporary	12.0	4.9	3.5	10.5	RS4900		4.9	5.5	3.2	TM0011
								4.9	4.9	3.8	TM0010

Tool Drivers

	Description	L	Catalog No.		Description	L	Catalog No.
	1.27 Hex Hand Driver Short	22.4	RS6095		1.27 Hex Hand Driver Medium	28.4	RS6094

TMA™ - Multi Unit Recommended Torque 35(Ncm)

Our TMA™ (Trans Mucosal Abutment) system is indicated for multiple-unit, screw-retained restorations and may be used in combination with an implant level framework design.

The TMA™ system is used to elevate the restorative seating platform when restoration at implant level is not indicated or practical due to the depth or angle of the implant.

The TMA™ System is designed to allow better prosthetics access when using implants with divergent angles accommodate full and partial edentulous arches, especially when using angled implants and all-on-x technique for full arch restoration.

The TMA™ abutment system is available in straight or angled (17°, 30°, 45°, 52°, 60°), engaging the Internal Hex for indexing, with a selection of collar heights. Abutments are delivered with handles for easy insertion and to assist with seating.

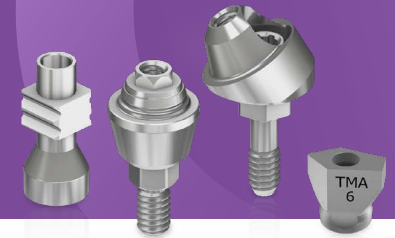

		Description	GH	Catalog No.
		RS Straight TMA 1mm	1.0	RS3731
		RS Straight TMA 2mm	2.0	RS3732
		RS Straight TMA 3mm	3.0	RS3733
		RS Straight TMA 4mm	4.0	RS3729
		RS Straight TMA 5mm	5.0	RS3730
		RS Angled TMA 17° 2mm	2.0	RS3734
		RS Angled TMA 30° 3mm	3.0	RS3735
		RS Angled TMA 17° 3mm	3.0	RS3737
		RS Angled TMA 30° 4mm	4.0	RS3738
		RS Angled TMA 45° 4mm	4.0	RS3736
		RS Angled TMA 52° 5mm	4.9	RS3739
		RS Angled TMA 60° 5mm	5.8	RS3740

Transfers

	TMA Impression Coping Open Tray	11.0	4.9	3.1	RS5006
	TMA Closed Tray Transfer	8.0	4.9	4.1	RS5011
	TMA Healing Cup	5.5	4.9	3.5	RS5005

Analogs

	Description	L	D1	D2	Catalog No.
	TMA Abutment Replica	16.8	3.35	-	RS5004
	TMA Digital Model Replica Recommended torque 15(Ncm)	12.0	4.9	3.8	RS1001



	Description	L	D1	Catalog No.
	TMA Scan Body	6.0	4.9	TM0006
		9.0	4.9	TM0009

TMA Screw For Scan Body & Cementing Cone





	Description	Catalog No.
	TMA Scan Body Screw	TM0001

	Description	Catalog No.
	TMA Prosthetic Screw	RS3404

Snap-On





	Description	L	D1	D2	Catalog No.		Description	Catalog No.
	TMA Snap-On Transfer	8.0	4.9	3.2	RS5012		IRIS™, Impression coping	IR0179

TMA Prosthetics







	Description	L	D1	D2	H	Catalog No.		Description	L	D1	D2	H	Catalog No.
	TMA Titanium Temporary	12.0	4.9	3.5	10.5	RS4900		TMA Cementing Cone, low profile	4.9	5.5	3.2		TM0011
	TMA Plastic Casting Sleeve /Prosthetic Screw	12.0	4.9	3.3	10.5	RS5001		TMA Cementing Cone	4.9	5.5	2.9		TM0010







Tool Drivers | For Angled TMA/TMA Prosthetic Screws

For Angled TMA/TMA prosthetic screw

	Description	L	Catalog No.
	Star Hand Driver Short	23.4	RP0064
	Star Hand Driver Long	28.4	RP0004
	Star Torque Driver-Short	20.4	RP0065
	Star Torque Driver-Long	25.4	RP0005

For straight TMA

	Description	L	Catalog No.
	TMA/FC Hex Torque Driver - Short	20	RS6197
	TMA/FC Hex Torque Driver - Long	25	RS6196
	TMA/FC Female Hand Hex Driver-Short	22.4	RS6193
	TMA/FC Female Hand Hex Driver-Long	28.4	RS6191
	TMA/FC Hex Handpiece Adapter-Short	20	RS6194
	TMA/FC Hex Handpiece Adapter-Long	25	RS6195A

	Description	Catalog No.		Description	Catalog No.		Description	Catalog No.
	RS Angled Trans Mucosal Abutment Gauge 60°	RS3745		RS Angled Trans Mucosal Abutment Gauge 52°	RS3744		RS Angled Trans Mucosal Abutment Gauge 45°	RS3743
	RS Angled Trans Mucosal Abutment Gauge 30°	RS3742		RS Angled Trans Mucosal Abutment Gauge 17°	RS3741		RS Angled Trans Mucosal Abutment Gauge Kit	RS3747

Overdenture Restoration

Recommended Torque 35(Ncm)



		Description	GH	RH	H	Catalog No.
		RS Ball Attachment w/Hex	1.0	2.7	0.2	RS2861
			2.0	2.7	1.2	RS2862
			3.0	2.7	2.2	RS2863
			4.0	2.7	3.2	RS2864
			5.0	2.7	4.2	RS2865
			6.0	2.7	5.2	RS2866
		RS Ball Attachment	0.5	2.45	2.95	RS2650
			1.0	2.45	3.45	RS2651
			2.0	2.45	4.45	RS2652
			3.0	2.45	5.45	RS2653
			4.0	2.45	6.45	RS2654
		5.0	2.45	7.45	RS2655	

	Description	L	Ø	Catalog No.
	Ball Attachment Replica	16.6	4.0	RS5740

	Description	L	Ø	D2	Catalog No.
	Plastic Ball Cap White (Nylon)	2.6	4.1	3.6	RS2660
	Plastic Ball Cap Pink Soft (Nylon)	2.6	4.1	3.6	RS2662
	Titanium Ball Cap	2.9	4.7	4.7	RS2670

	Description	Catalog No.
	Torque Driver for Ball Attachment	RS6090

Grip™ - Overdenture Attachment

As an addition to our wide variety of prosthetic solutions.

Implant supported overdentures are among the most practical prosthetic solutions for patients who cannot utilize fixed restorations, or as an interim solution for patients who are waiting for the osseointegration process of their newly placed implants.

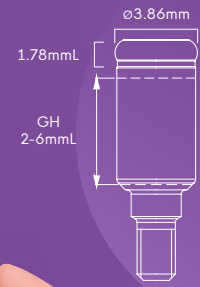

The Grip™ attachment system is a versatile solution, designed to ensure maximum denture retention and stability both for maxillary and mandibular dentures. The variety of retentive caps allow dentists to choose the required retention level needed for each individual case and can easily be replaced, when needed.

The Grip™ attachment system is available for Internal Hex in a range of gingival heights, to enable a reliable, long lasting and cost-effective solution for your patients.









Grip™ Abutments

	Description	Catalog No.
	Grip RS Abutment 1mm	RS3037
	Grip RS Abutment 2mm	RS3032
	Grip RS Abutment 3mm	RS3033
	Grip RS Abutment 4mm	RS3034
	Grip RS Abutment 5mm	RS3035
	Grip RS Abutment 6mm	RS3036

	Description	Catalog No.
	Grip™ for TMA	TM0100
	Grip™ for Bar, M2 thread	RS0101







Included in Sales Pack

Grip™ Processing Set

	Description		Description	Catalog No.
	Housing		Light	RS6426
	Processing		Regular	
	Extra Light		Block Out Spacer	











Grip™ Extended Range processing set

	Description		Description	Catalog No.
	Housing		Light	RS6427
	Processing		Regular	
	Zero		Block Out Spacer	
	Extra Light			



Grip™ Retention Caps

Grip Retention 4 Pack		Description	Catalog No.
		Extra Light	RS6417
		Light	RS6418
		Regular	RS6419

Grip™ Extended Range Retention 4 Pack		Description	Catalog No.
		Zero	RS6420
		Extra Light	RS6421
		Light	RS6422
		Regular	RS6423



Grip™ Accessories

	Description	Catalog No.		Description	Catalog No.
	Grip™ Impression Coping 4 Pack Includes RS6415 Grip™ Processing 4 Pack	RS6414		Grip™ Replica 4 Pack	RS2508
	Metal Housing 4 Pack Includes RS6415 Grip™ Processing 4 Pack	RS6413			Grip™ Processing 4 Pack
	Grip™ Block Out Spacer 4 Pack	RS6424			Grip™ Processing 20 Pack

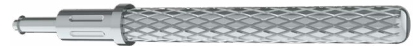
Grip™ Tools

	Description	Catalog No.
	Grip™ core tool	RS6200

Designed for inserting and removing the Grip™ retention males from the metal housing

	Description	Catalog No.		Description	Catalog No.		Description	Catalog No.
	1.27 Hex hand driver-medium	RS6094		1.27 Hex torque driver-long	RS6082		1.27 Hex driver for handpiece - long	RS9035
	1.27 Hex hand driver-short	RS6095		1.27 Hex torque driver-short	RS6080		1.27 Hex driver for handpiece - short	RS9030

Surgical Kits

Successful surgical procedures start with having the right instruments and tools to ensure your desired treatment outcomes are met.

That's why our range has everything you need, including drills, keys, ratchets and insertion tools.

Not only do they make procedures safer and simpler, they result in an enhanced patient experience as well.

Our Surgical Kits streamline and simplify your implant procedures.



Premium Kit RS6301

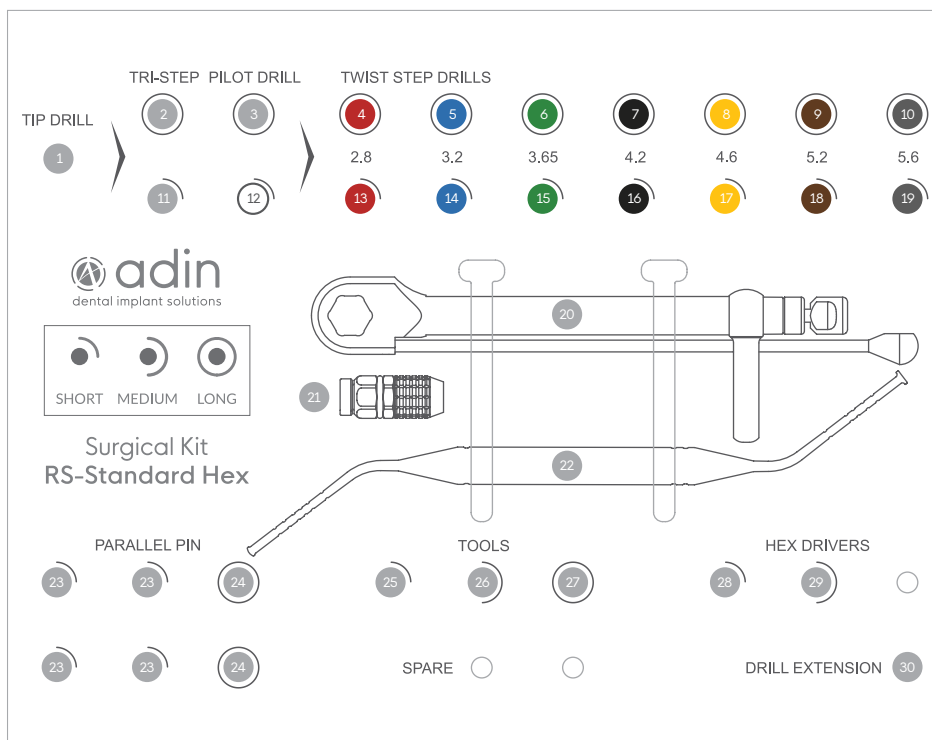

Drills		Catalog No.	Surgical Tools		Catalog No.
1		RS8032	20		RS6111
2		TD2218	21		RA0050
3		DL1820	22		RS6180
4		DL1828			
5		DL1832			
6		DL1836			
7		DL1842			
8		DL1846			
9		DL1852			
10		DL1856			
11		TD1511			
12		DL1320			
13		DL1328			
14		DL1332			
15		DL1336			
16		DL1342			
17		DL1346			
18		DL1352			
19		DL1356			
			Parallel Pins		Catalog No.
			23		RS6150
			24		RS6155
			Insertion Tools		Catalog No.
			25		RS9021
			26		RS9026
			27		RS9029
			Hex Drivers		Catalog No.
			28		RS6095
			29		RS6094
			Drill Extension		Catalog No.
			30		RS9027

*Products may be ordered separately as an addition to the kit

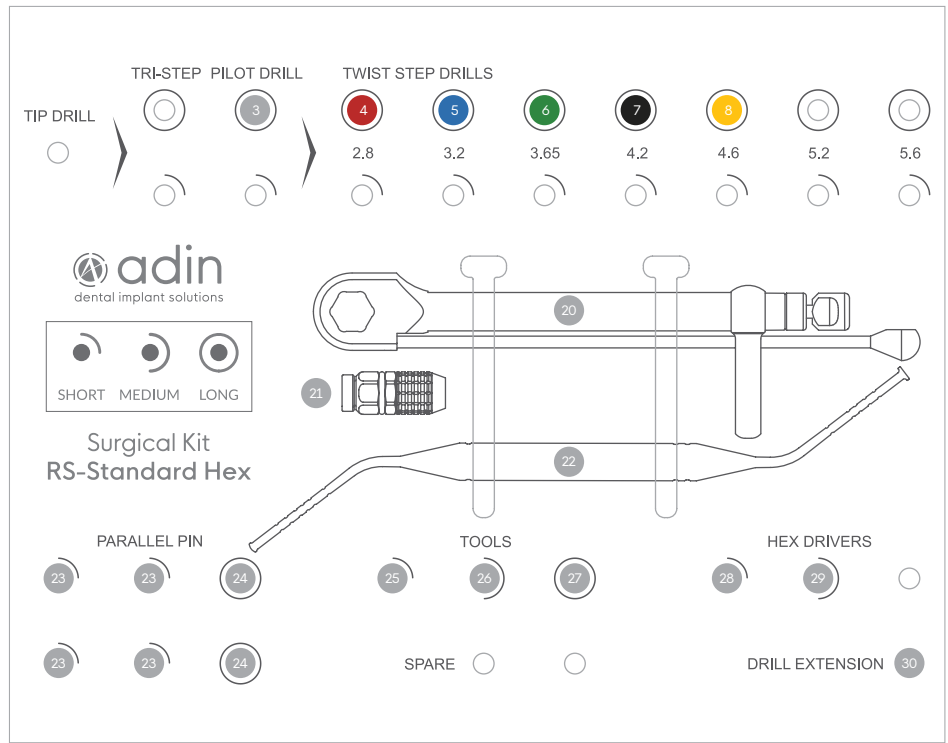

	Drills	Catalog No.
3	Pilot Drill 2mmD x 8-18mmL	DL1820
4	Twist Step Drill 2.3/2.8mmD x 8-18mmL	DL1828
5	Twist Step Drill 2.8/3.2mmD x 8-18mmL	DL1832
6	Twist Step Drill 3.2/3.6mmD x 8-18mmL	DL1836
7	Twist Step Drill 3.8/4.2mmD x 8-18mmL	DL1842
8	Twist Step Drill 4.2/4.6mmD x 8-18mmL	DL1846

	Parallel Pins	Catalog No.
23	Parallel Pin Short 11mm (qty. 4)	RS6150
24	Parallel Pin Short 16mm (qty. 2)	RS6155

	Insertion Tools	Catalog No.
25	RS Hex Handpiece Adapter-Short	RS9021
26	RS Hex Handpiece Adapter-Medium	RS9026
27	RS Hex Handpiece Adapter-Long	RS9029

	Surgical Tools	Catalog No.
20	Surgical Torque Ratchet 35-100 Ncm	RS6111
21	Wrench Ratchet Surgical Instruments Handle	RA0050
22	Depth Probe	RS6180

	Hex Drivers	Catalog No.
28	1.27 Hex Hand Driver - Short	RS6095
29	1.27 Hex Hand Driver - Medium	RS6094

	Drill Extension	Catalog No.
30	Drill Extension	RS9027

*The advanced kit is also available with short drills | Catalog No. RS6324

Starter Kit RS6333

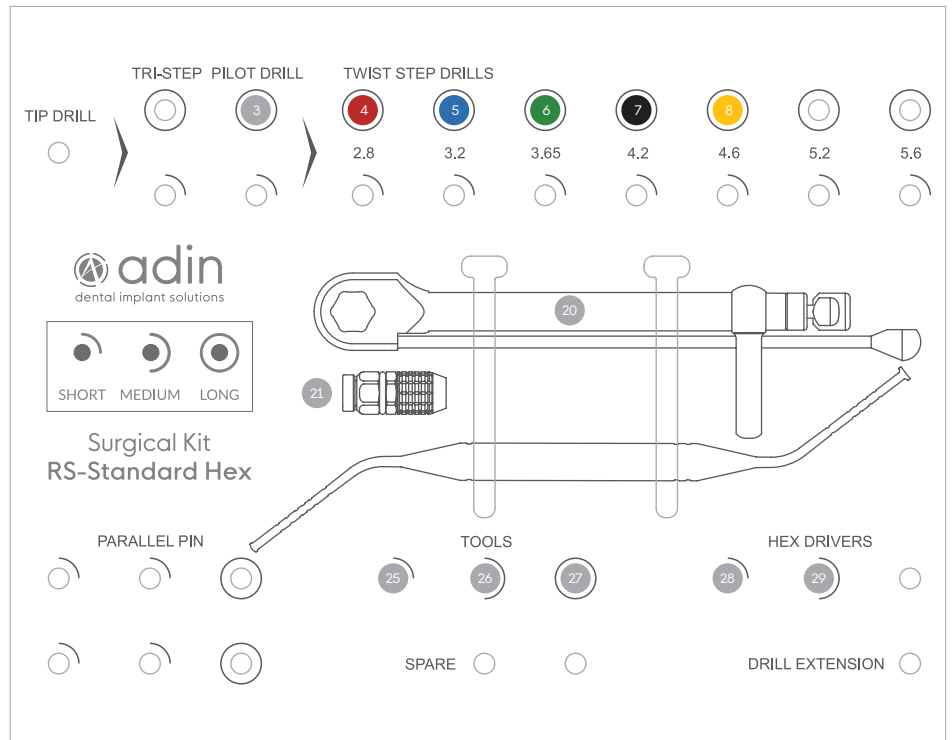

	Drills	Catalog No.
3	Pilot Drill 2mmD x 8-18mmL	DL1820
4	Twist Step Drill 2.3/2.8mmD x 8-18mmL	DL1828
5	Twist Step Drill 2.8/3.2mmD x 8-18mmL	DL1832
6	Twist Step Drill 3.2/3.6mmD x 8-18mmL	DL1836
7	Twist Step Drill 3.8/4.2mmD x 8-18mmL	DL1842
8	Twist Step Drill 4.2/4.6mmD x 8-18mmL	DL1846

	Insertion Tools	Catalog No.
25	RS Hex Handpiece Adapter-Short	RS9021
26	RS Hex Handpiece Adapter-Medium	RS9026
27	RS Hex Handpiece Adapter-Long	RS9029

	Hex Drivers	Catalog No.
28	1.27 Hex Hand Driver - Short	RS6095
29	1.27 Hex Hand Driver - Medium	RS6094

	Surgical Tools	Catalog No.
20	Wrench Ratchet	RS6100
21	Wrench Ratchet Surgical Instruments Handle	RA0050

*The starter kit is also available with short drills | Catalog No. RS6334

Drills and Tools

Our DLC (Diamond Like Carbon) Tri-Step/Twist Step Surgical Drills are uniquely designed and coated to improve the surgical drilling process.

Tri-Step & Twist-Step DLC drills simplify the cutting process, save time and minimize risks.

Our improved DLC drill coating provides state-of-the-art hardness and slickness that increases lifespan of the drill, maintains sharpness for extended drilling and generates less heat, thereby reducing chances of heating the bone or complications arising from conventional drilling protocols.

The drills come in the following diameters (mm): 2.0, 2.5, 2.8, 3.2, 3.6, 4.2, 4.6, 5.2, 5.6

Specially designed for Adin's implants and suitable for their simple and convenient drilling protocol.

They are clearly and conveniently marked and can be used with or without drill stops.



Tri-Step drills









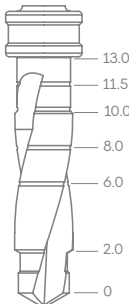

Adin's Tri-Step drills condense drilling protocols and avoid the need for using multiple drills throughout complex procedures.

Because friction at the cutting site is reduced, complications common with high speed drilling are decreased and faster & better recovery can occur.









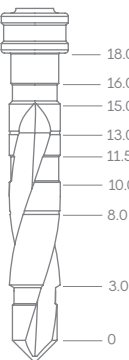

L		Ø	Size	Catalog No.
		1.8-3.2	Short	TD1511
		1.8-3.2	Long	TD2218

Twist Step drills

Short 6-13mm





L		∅	Color	Catalog No.
		2.0	White	DL1320
		1.8-2.5	Purple	DL1325
		2.3-2.8	Red	DL1328
		2.8-3.2	Blue	DL1332
		3.2-3.6	Green	DL1336
		3.9	Pink	DL1339
		3.8-4.2	Black	DL1342
		4.2-4.6	Yellow	DL1346
		4.8-5.2	Brown	DL1352
		5.2-5.6	Grey	DL1356











Long 8-18mm

L		∅	Color	Catalog No.
		2.0	White	DL1820
		1.8-2.5	Purple	DL1825
		2.3-2.8	Red	DL1828
		2.8-3.2	Blue	DL1832
		3.2-3.6	Green	DL1836
		3.9	Pink	DL1839
		3.8-4.2	Black	DL1842
		4.2-4.6	Yellow	DL1846
		4.8-5.2	Brown	DL1852
		5.2-5.6	Grey	DL1856

Surgical Tools



	Description	Catalog No.
	Surgical Torque Ratchet 35-100 Ncm	RS6111
	Wrench Ratchet	RS6100
	Surgical Driver	RS7001
	Depth Probe	RS6180







	Description	Catalog No.
	Wrench Ratchet Surgical Instruments Handle 17mm	RA0050
	Drill Extension	RS9027
	Parallel Pin 11mm	RS6150
	Parallel Pin 16mm	RS6155
	RS 2.4 Hex Torque Driver 17mm	RS6011
	RS 2.4 Hex Torque Driver 27mm	RS6012
	RS Hex Handpiece Adapter 20mm	RS9020
	RS Hex Handpiece Adapter 25mm	RS9025
	RS Hex Handpiece Adapter 23.7 mm	RS9021
	RS Hex Handpiece Adapter	28.6 mm RS9026
		36 mm RS9029

Prosthetic Tools







Ratchet

	Description	Catalog No.
	Prosthetic Torque Ratchet 15-35 Ncm	RS6112

	Description	Catalog No.
	1.27 Hex Torque Driver 20.4mm	RS6080
	1.27 Hex Torque Driver 25.4mm	RS6082
	TMA/FC Hex Torque Driver 25mm *For straight TMA/Flat connection	RS6196
	TMA/FC Hex Torque Driver 20mm *For straight TMA/Flat connection	RS6197
	Star Torque Driver 20.4mm *For Angled TMA/TMA prosthetic screw	RP0065
	Star Torque Driver 25.4mm *For Angled TMA/TMA prosthetic screw	RP0005
	Torque Driver for Ball Attachment 14.4mm	RS6090

Handpiece

	Description	Catalog No.
	1.27 Hex Driver for Handpiece 30mm	RS9035
	1.27 Hex Driver for Handpiece 25mm	RS9030
	TMA/FC Hex Handpiece Adapter 25mm *For straight TMA/Flat connection	RS6195A
	TMA/FC Hex Handpiece Adapter 20mm *For straight TMA/Flat connection	RS6194





Retrieval Screw

	Description	Catalog No.
	RS Retrieval Screw For Abutments 15mm	RS3401

Hand Drivers

	Description	Catalog No.
	1.27 Hex Hand Driver 46.4mm	RS6097
	1.27 Hex Hand Driver 28.4mm	RS6094
	1.27 Hex Hand Driver 22.4mm	RS6095
	TMA/FC Female Hand Hex Driver 28.4mm *For straight TMA/Flat connection	RS6191
	TMA/FC Female Hand Hex Driver 22.4mm *For straight TMA/Flat connection	RS6193
	Star Hand Driver 23.4mm *For Angled TMA/TMA prosthetic screw	RP0064
	Star Hand Driver 28.4mm *For Angled TMA/TMA prosthetic screw	RP0004

Osteotomes

	Description	Catalog No.
	Osteotome Handle	HA0074
	Osteotome Insert 2.0mmD	HA0061
	Osteotome Insert 2.8mmD	HA0064
	Osteotome Insert 3.25mmD	HA0067
	Osteotome Insert 3.65mmD	HA0070

Guided Surgery

The adinguide™ was created with you in mind, bringing the guided surgery world to your clinic.

The kits were specifically designed to support effortless procedures, accurate and predictable implant placement.

The ActiveFlow™ Irrigation Technology is a unique design that forces coolant through the guide to ensure irrigation reaches the bone and prevents overheating.

The adinguide™ drills are designed with carved channels which allow saline coolant from your hand-piece to stream through the sleeve directly into the osteotomy site while drilling.

Our uniquely designed drill kit is intuitive and easy to use by implant diameter and length.

The Tissue Punch and Pilot Drill allow for easy flapless access.

Keyless procedure enables easy handling and full visibility of surgical field.

Self-centering drills- controlled by a 5.5mm diameter cylinder at the top of each drill centers the drill in the guide's sleeve.

























Self-centering cylinder engages the sleeve before the drill engages the osteotomy in order to ensure correct positioning of the drill.

Built-in stoppers- ensure precise and accurate drilling to the desired depth.



Guided Surgery Kit Implants Drills GSK001



	Drills	Catalog No.		Drills	Catalog No.
1		GS5055	5		GS0638
2		GS0625	9		GS0838
3		GS0825	13		GS1038
7		GS1025	17		GS1138
11		GS1125	21		GS1338
15		GS1325	24		GS1638
19		GS1625	6		GS0646
4		GS0632	10		GS0846
8		GS0832	14		GS1046
12		GS1032	18		GS1146
16		GS1132	22		GS1346
20		GS1332	25		GS1646
23		GS1632			



For full
guided
procedure:



RS Touareg™ S/OS
Implant Platform











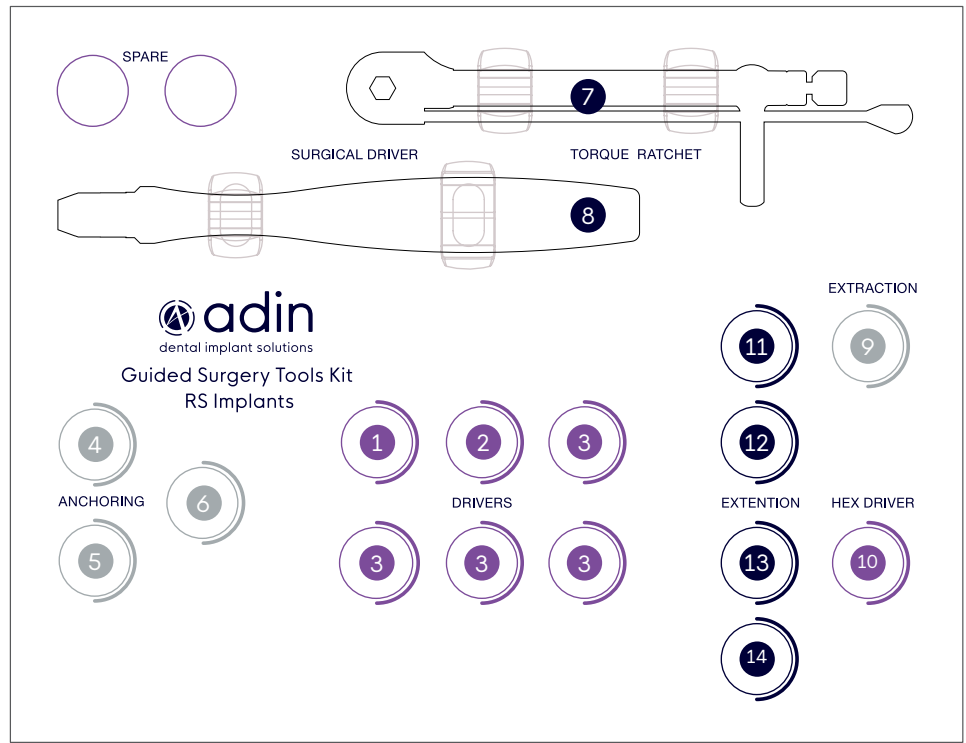





GS Tools Kit RS
GSK003



5.5mmD
SleeveGS0055

Guided Surgery Kit
RS Touareg™
Implants Tools
GSK003







	Drills	Catalog No.
1	 RS Handpiece Fixture Mount	GS0032
2	 RS Grip Fixture Mount	GS0034
3	 RS Screw Fixture Mount (qty 4)	GS0029
4	 Anchoring Drill S-2.0, 2.0/1.7mmDx19mmL	GS1917
5	 Anchoring Drill S-2.0, 2.0/1.5mmDx19mmL	GS1915
6	 Handpiece Guide Fixation Screw Driver	GS0028
7	 Surgical Torque Ratchet 35-100 Ncm for hex 4mm	GS6111
8	 Guide Fixation Screw Driver	GS0027
9	 RS Extraction Tool	GS0035
10	 1.27 Hex Hand Driver-Medium	RS6094
11	 Manual Socket L10.5	GS0023
12	 Manual Socket L14.5	GS0024
13	 Handpiece Socket L10.5	GS0021
14	 Drill Extension	RS9027







Sold separately



18mm Drills

	Description	Catalog No.
	Drill S-5.5, 2.5/1.8mmDx18.0mmL	GS1825
	Drill S-5.5, 3.2/2.5mmDx18.0mmL	GS1832
	Drill S-5.5, 3.85/3.2mmDx18.0mmL	GS1838
	Drill S-5.5, 4.6/3.85mmDx18.0mmL	GS1846
	Drill S-3.3, 2.5/1.8mmDx18.0mmL	GSN1825

Accessories

	Description	Purchase Options	Catalog No.
	Guided Vertical Fixation Screw S-5.5	x3 pack	GS0007
	2.0mmD Anchoring Screw	x3 pack	GS1920
	2.0mmD Anchoring Sleeve	x3 pack	GS0020
	5.5mmD Sleeve	x1 pack	GS0055
		x3 pack	GS0055x3
		x10 pack	GS0055x10

* Illustrations are not to scale

* Availability of the products in some places is limited and depends on local regulations.

* For more information, please contact your local representative.





UniFit™



Introducing UniFit™, your Unified Connection to hassle-free implants. With 30 years of implantology knowledge and experience, we have taken the best of our platforms and combined them into our new UniFit™ implant.

Surgical and restoration procedures can be complicated, which is why we are focused on making them simple. With UniFit, one prosthetic connection fits all.

This means that ALL prosthetics and attachments fit ALL size and diameter UniFit implants. This means:

No need for spares, no multiple sizes for handpieces, no extra storage for all the extra prosthetics!

Our innovative implant design features a friction 7° conical connection with a six-position star shape index that allows for one unified prosthetic connection to fit all implant diameters. This simplifies surgical and restoration procedures, making the process faster and more efficient.

UniFit™ ensures a solid fixture of the abutment, enhancing the implant-abutment seal and minimizing micromovements. Our unique design also enables simple yet flexible implant and abutment alignment, allowing for self-guiding insertion and clear-cut tactile feedback.

The external geometry and surface of UniFit™ are designed for immediate function and loading, providing optimal stability in all bone types. Every feature of UniFit™ is designed to enhance the success of the procedure and deliver better results, ensuring a better experience for both doctors and patients.

In short, the concept behind UniFit™ is simple, but the results are immediate. Say goodbye to complicated dental implant procedures and hello to a hassle-free experience with UniFit™.

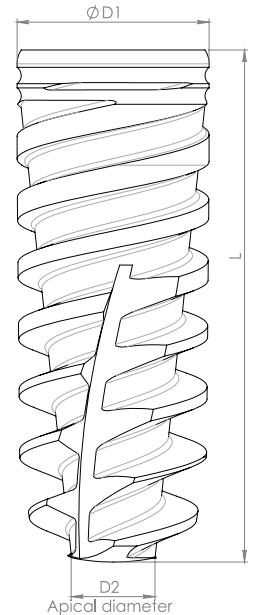
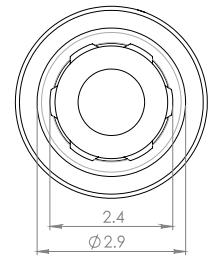

Built-In Platform Switching

Back tapered collar

Engineered to enhance bone regeneration, prevent bone loss & increase bone implant contact

Minimally invasive surgery

OsseoFix™ surface

Bone-condensing property
Self-drilling

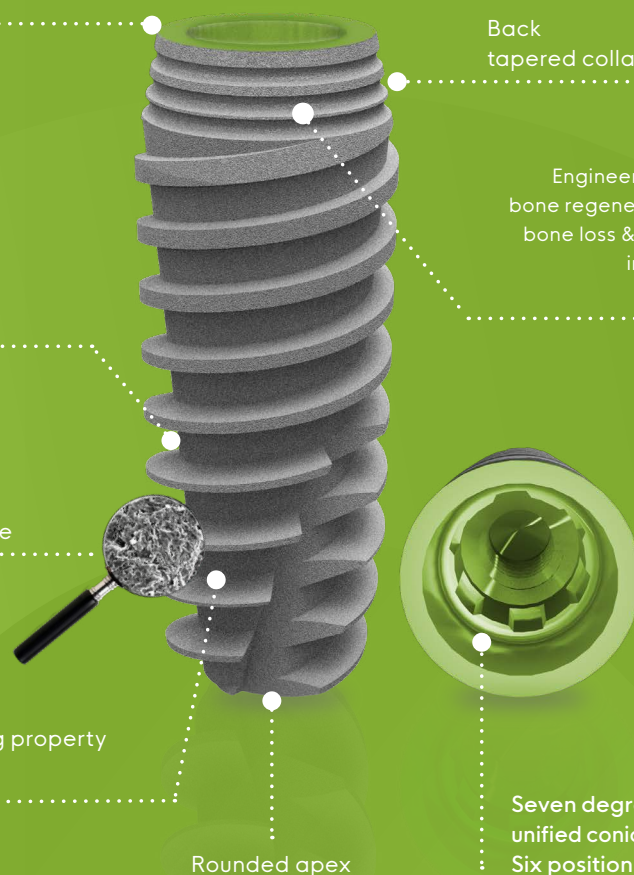

Rounded apex

Seven degrees unified conical connection
Six position star index



UniFit™

Recommended insertion torque up to 50 Ncm

	D1	L	D2	Catalog No.
	3.5	8.0	1.50	ISPUF0835
		10.0	1.50	ISPUF1035
		11.5	1.50	ISPUF1135
		13.0	1.50	ISPUF1335
		16.0	1.50	ISPUF1635
		18.0	1.50	ISPUF1835
	3.75	8.0	1.60	ISPUF0838
		10.0	1.60	ISPUF1038
		11.5	1.60	ISPUF1138
		13.0	1.60	ISPUF1338
		16.0	1.60	ISPUF1638
		18.0	1.60	ISPUF1838
	4.3	6.0	2.00	ISPUF0643
		8.0	1.90	ISPUF0843
		10.0	1.90	ISPUF1043
		11.5	1.90	ISPUF1143
		13.0	1.90	ISPUF1343
		16.0	1.90	ISPUF1643
	18.0	1.90	ISPUF1843	

	D1	L	D2	Catalog No.
	5.0	6.0	2.50	ISPUF0649
		8.0	2.25	ISPUF0849
		10.0	2.25	ISPUF1049
		11.5	2.25	ISPUF1149
		13.0	2.25	ISPUF1349
		16.0	2.25	ISPUF1649
	6.0	6.0	3.50	ISPUF0660
		8.0	3.50	ISPUF0860
		10.0	3.50	ISPUF1060
		11.5	3.50	ISPUF1160
		13.0	3.50	ISPUF1360

Radiographic Template UniFit™ | ASD0617

Drill Sequence for UniFit™ Recommended drilling speed up to 1200 rpm

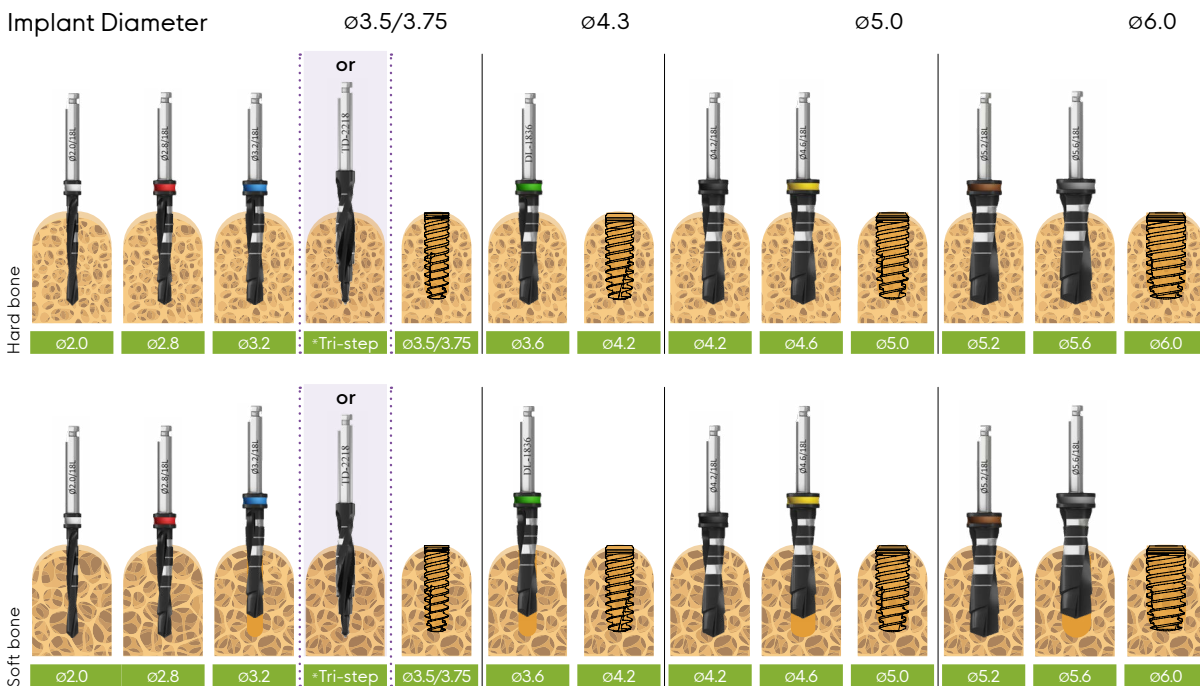

All measurements are in mm.

*For initial drilling, you may use Tri-step drill instead of ø2, ø2.8 and ø3.2 drills in sequence.

Note: (x.xx) Drill to the depth of the cortex only. All measurements are in mm.

⚠ CAUTION: The drill preparation is up to 1mm longer than the implant. * The drill apical step = 1.8mmD

Cover Screw & Healing Abutments





Recommended Torque 15(Ncm)



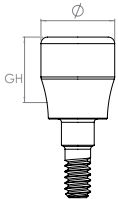

Cover Screw Packed with implant

		Description	Catalog No.
		Cover Screw	UF0073

Healing Abutments

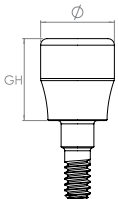
		Description	GH	Ø	Catalog No.
		UniFit Slim Conical Healing Abutment	2.0	3.5	UF0095
			3.0	3.5	UF0096
			4.0	3.5	UF0097
			5.0	3.5	UF0098
			6.0	3.5	UF0099
		UniFit Regular Conical Healing Abutment	2.0	4.5	UF0090
			3.0	4.5	UF0091
			4.0	4.5	UF0092
			5.0	4.5	UF0093
			6.0	4.5	UF0094
		UniFit Wide Conical Healing Abutment	2.0	5.5	UF0095W
			3.0	5.5	UF0096W
			4.0	5.5	UF0097W
			5.0	5.5	UF0098W
			6.0	5.5	UF0099W

		Description	GH	Ø	Catalog No.
		UniFit Slim Healing Abutment	2.0	3.5	UF0046
			3.0	3.5	UF0047
			4.0	3.5	UF0048
			5.0	3.5	UF0049
			6.0	3.5	UF0050
		UniFit Regular Healing Abutment	2.0	4.5	UF0022
			3.0	4.5	UF0023
			4.0	4.5	UF0024
			5.0	4.5	UF0025
			6.0	4.5	UF0026
		UniFit Wide Healing Abutment	2.0	5.5	UF0046W
			3.0	5.5	UF0047W
			4.0	5.5	UF0048W
			5.0	5.5	UF0049W
			6.0	5.5	UF0050W

Impression

Recommended Torque 15(Ncm)

Our components for taking impressions for all restoration types can be successfully utilized for digital or conventional protocols either implant-level or abutment level procedures.

Our broad range of solutions and flexible designs enable easy and accurate restorative planning, whether you're dealing with a single tooth, multiple teeth, bridge or full mouth rehabilitation.



Transfers | Recommended Torque 15(Ncm)

		Unifit Open Tray Transfer Short	19.0	6.0	10.0	UF5610
		Unifit Open Tray Transfer Long	23.0	6.0	14.0	UF5614

	Close Tray	Description	L	D1	H	Catalog No.
		Unifit Close Tray Transfer Short	11.0	3.4	9.0	UF5109
		Unifit Close Tray Transfer Long	15.0	3.4	13.0	UF5113

Scan Bodies

	Description	H	Catalog No.		Description	H	Catalog No.
	Unifit Scan Body	7	UF0088		Unifit Scan Body	10	UF0089

Analogs





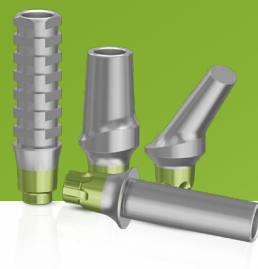

	Unifit Digital Model Analog	10.0	3.55	UF1000		Retaining Screw	RS1002		Unifit Implant Analog	12.6	3.6	UF0007
--	-----------------------------	------	------	--------	--	-----------------	--------	--	-----------------------	------	-----	--------

Temporary & Cement Retained Restoration

Recommended Torque 35(Ncm)



		UniFit Engaging Temporary Abutment Slim 3.5mmD	3.5	2	9.5	UF0036
		UniFit Non-Engaging Temporary Abutment Slim 3.5mmD	3.5	2	9.5	UF0037
		UniFit Engaging Temporary Abutment 4.5mmD	4.5	2	9.5	UF0043
		UniFit Engaging Temporary Abutment Wide 5.5mmD	5.5	2	9.5	UF0043W
		UniFit Non-Engaging Temporary Abutment 4.5mmD	4.5	2	9.5	UF0044
		UniFit Non-Engaging Temporary Abutment Wide 5.5mmD	5.5	2	9.5	UF0044W
		UniFit Straight Abutment	4.4	3.0	6.5	UF0010
			4.4	2.0	6.5	UF0011
			4.4	1.0	6.5	UF0012
		UniFit Straight Abutment Wide	5.1	3.0	6.5	UF0010W
			5.1	2.0	6.5	UF0011W
			5.1	1.0	6.5	UF0012W
		UniFit Straight Abutment Long	4.4	1.0	12.5	UF1251
			4.4	2.0	12.5	UF1252
			4.4	3.0	12.5	UF1253
	UniFit Straight Abutment Long Wide	5.1	1.0	12.5	UF1251W	
		5.1	2.0	12.5	UF1252W	
		5.1	3.0	12.5	UF1253W	
	UniFit Straight Slim Abutment No End Line	4.0	2.3	6.0	UF0020	

		Description	D1	GH	RH	Catalog No.
		UniFit Angled Abutment 15°	4.4	1.0	6.5	UF0013
			4.4	2.0	6.5	UF0014
			4.4	3.0	6.5	UF0015
		UniFit Angled Abutment Wide 15°	5.1	1	6.5	UF0013W
			5.1	2	6.5	UF0014W
			5.1	3	6.5	UF0015W
		UniFit Angled Abutment 25°	4.4	1.5	6.5	UF2515
			4.4	3.0	6.5	UF2530
		UniFit Angled Abutment Wide 25°	5.1	1.5	6.5	UF2515W
			5.1	3	6.5	UF2530W
		UniFit Angled Abutment Wide 35°	5.1	1.5	6.5	UF3515W
			5.1	3	6.5	UF3530W

Screw - Retained Restoration Casting Abutments

Recommended Torque 35(Ncm)

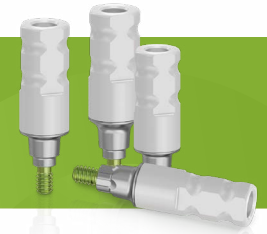

		Description	D1	GH	RH	Catalog No.	
		UniFit Plastic Cylinder Abutment Slim 3.5mmD	3.5	2	9.5	UF0038	
			UniFit Plastic Cylinder Abutment 4.5mmD	4.5	2	9.5	UF0045
			UniFit Plastic Cylinder Abutment Wide 5.5mmD	5.5	2	9.5	UF0045W
		UniFit Engaging Cobalt Chrome/Plastic Abutment	3.9	1	10	UF3094	
		UniFit Engaging Titanium/Plastic Abutment	4.7	1.5	10	UF3095	
		UniFit Non-Engaging Titanium/Plastic Abutment	4.7	1.5	10	UF3097	
		UniFit Non-Engaging Cobalt Chrome/Plastic Abutment	3.9	1	10	UF3100	
		UniFit Engaging Cobalt Chrome/Plastic Abutment Wide	4.6	1	10	UF3094W	
		UniFit Engaging Titanium/Plastic Abutment Wide	5.2	1.5	10	UF3095W	
		UniFit Non-Engaging Titanium/Plastic Abutment Wide	5.2	1.5	10	UF3097W	
		UniFit Non-Engaging Cobalt Chrome/Plastic Abutment Wide	4.6	1	10	UF3100W	

Single TMA™ Recommended Torque 35(Ncm)

Adin's range of screw-retained restorations has expanded to include the single TMA (STMA). This option offers the benefits of TMA abutments while still allowing for accurate and flexible restoration of a single tooth.

With Adin's STMA, you can combine the advantages of a trans-gingival approach and a screw-retained single tooth restoration, resulting in increased flexibility in terms of aesthetics, safety, and maintenance.

The Single TMA also includes a hex index that provides the necessary accuracy for positioning and retention to support a single tooth crown. You can choose from open and closed tray transfers, and scan bodies for digital impressions, and replicas are available to streamline the work process.

		Description	GH	Catalog No.
		UniFit Straight Single TMA 1mm	1.0	UF0032S
		UniFit Straight Single TMA 2mm	2.0	UF0033S
		UniFit Straight Single TMA 3mm	3.0	UF0034S
		UniFit Straight Single TMA 4mm	4.0	UF3729S
		UniFit Straight Single TMA 5mm	5.0	UF3730S
		UniFit Angled Single TMA 17° 2.5mm	2.5	UF3734S
		UniFit Angled Single TMA 30° 3mm	3.0	UF3735S
		UniFit Angled Single TMA 17° 3.5mm	3.5	UF3737S
		UniFit Angled Single TMA 30° 4mm	4.0	UF3738S

	Description	L	D1	D2	Catalog No.		Description	L	D1	D2	Catalog No.
	Single TMA Impression Coping Open Tray	11.0	4.9	3.1	RS5006S		Single TMA Closed Tray Transfer	8.0	4.9	4.1	RS5011S

Snap-On

	Description	L	D1	D2	Catalog No.		Description	L	D1	D2	Catalog No.
	Single TMA Snap-On Transfer	8.0	4.9	3.2	RS5012S		IRIS™, Impression coping				IR0179

Analog

	Description	L	D1	Catalog No.		Description	L	D1	D2	Catalog No.
	Single TMA Abutment Replica	16.8	3.35	RS5004S		Single TMA Digital Model Replica Recommended torque 15(Ncm)	12.0	4.9	3.8	RS1001S

Scan Bodies





	Description	L	D1	Catalog No.
	Single TMA Scan Body	6.0	4.9	TM0006S
		9.0	4.9	TM0009S

STMA Screw Temporary Cylinder & STMA Direct Option

	Description	Catalog No.
	TMA Scan Body Screw	TM0001

	Description	Catalog No.
	TMA Prosthetic Screw	RS3404

STMA Prosthetics

	Description	L	D1	D2	D3	Catalog No.
	Single TMA Titanium Temporary	12.0	4.9	3.5	10.5	RS4900S
	Single TMA Plastic Casting Sleeve w/Prosthetic Screw	12.0	4.9	3.3	10.5	RS5001S
	Single TMA Healing Cup	5.5	4.9	3.5	-	RS5005S
	Single TMA Cementing Cone, low profile	4.9	5.5	3.2	-	TM0011S

	For Angled TMA/TMA prosthetic screw	L	Catalog No.
	Star Hand Driver Short	23.4	RP0064
	Star Hand Driver Long	28.4	RP0004





CAD CAM





Adin's CAD - CAM components and digital libraries enable clinicians and technicians to design and manufacture state-of-the-art restorations supported by Adin's implants, using current digital restoration processes.

The variety of components ensures endless restorative options for treatment of single, multiple, partially, or fully edentulous cases.

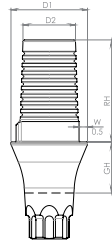

	Description	H	Catalog No.		Description	H	Catalog No.
	UniFit Scan Body	7	UF0088		UniFit Scan Body	10	UF0089

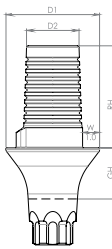
Ti Base Abutments | Recommended Torque 35(Ncm)

	Description	RH	GH	D1	D2	Catalog No.
	 Ti Base UniFit Abutment,	4.0	1.0	4.5	3.2	TB07411
		4.0	2.0	4.5	3.2	TB07421
		4.0	3.0	4.5	3.2	TB07431
		4.0	4.0	4.5	3.2	TB07441
		6.0	1.0	4.5	3.1	TB07611
		6.0	2.0	4.5	3.1	TB07621
		6.0	3.0	4.5	3.1	TB07631
		6.0	4.0	4.5	3.1	TB07641
		8.0	1.0	4.5	2.9	TB07811
		8.0	2.0	4.5	2.9	TB07821
		8.0	3.0	4.5	2.9	TB07831
		8.0	4.0	4.5	2.9	TB07841
	 Ti Base UniFit Abutment,	4.0	1.0	5.5	3.2	TB07411W
		4.0	2.0	5.5	3.2	TB07421W
		4.0	3.0	5.5	3.2	TB07431W
		4.0	4.0	5.5	3.2	TB07441W
		6.0	1.0	5.5	3.1	TB07611W
		6.0	2.0	5.5	3.1	TB07621W
		6.0	3.0	5.5	3.1	TB07631W
		6.0	4.0	5.5	3.1	TB07641W
		8.0	1.0	5.5	2.9	TB07811W
		8.0	2.0	5.5	2.9	TB07821W
		8.0	3.0	5.5	2.9	TB07831W
		8.0	4.0	5.5	2.9	TB07841W
	 Ti Base UniFit Abutment,	4.0	1.0	4.5	3.2	TB07412
		4.0	2.0	4.5	3.2	TB07422
		4.0	3.0	4.5	3.2	TB07432
		4.0	4.0	4.5	3.2	TB07442
		6.0	1.0	4.5	3.1	TB07612
		6.0	2.0	4.5	3.1	TB07622
		6.0	3.0	4.5	3.1	TB07632
		6.0	4.0	4.5	3.1	TB07642
		8.0	1.0	4.5	2.9	TB07812
		8.0	2.0	4.5	2.9	TB07822
		8.0	3.0	4.5	2.9	TB07832
		8.0	4.0	4.5	2.9	TB07842

	Description	RH	GH	D1	D2	Catalog No.
	<p>Ti Base UniFit Abutment, Non-Engaged Wide</p>	4.0	1.0	5.5	3.2	TB07412W
		4.0	2.0	5.5	3.2	TB07422W
		4.0	3.0	5.5	3.2	TB07432W
		4.0	4.0	5.5	3.2	TB07442W
		6.0	1.0	5.5	3.1	TB07612W
		6.0	2.0	5.5	3.1	TB07622W
		6.0	3.0	5.5	3.1	TB07632W
		6.0	4.0	5.5	3.1	TB07642W
		8.0	1.0	5.5	2.9	TB07812W
		8.0	2.0	5.5	2.9	TB07822W
		8.0	3.0	5.5	2.9	TB07832W
		8.0	4.0	5.5	2.9	TB07842W

C-Type Ti Base Abutments | Recommended Torque 35(Ncm)

For further product information and use please refer to IFU028

	Description	RH	GH	D1	D2	Catalog No.
	<p>C-Type Ti Base UniFit Abutment, Engaged</p>	4.7	1.0	4.3	2.9	TB07414
		4.7	2.0	4.3	2.9	TB07424
		4.7	3.0	4.3	2.9	TB07434
		4.7	4.0	4.3	2.9	TB07444
	<p>C-Type Ti Base UniFit Abutment, Engaged Wide</p>	4.7	1.0	6.0	2.9	TB07414W
		4.7	2.0	6.0	2.9	TB07424W
		4.7	3.0	6.0	2.9	TB07434W
		4.7	4.0	6.0	2.9	TB07444W
	<p>C-Type Ti Base UniFit Abutment, Non-Engaged</p>	4.7	1.0	4.3	2.9	TB07415
		4.7	2.0	4.3	2.9	TB07425
		4.7	3.0	4.3	2.9	TB07435
		4.7	4.0	4.3	2.9	TB07445
	<p>C-Type Ti Base UniFit Abutment, Non-Engaged Wide</p>	4.7	1.0	6.0	2.9	TB07415W
		4.7	2.0	6.0	2.9	TB07425W
		4.7	3.0	6.0	2.9	TB07435W
		4.7	4.0	6.0	2.9	TB07445W



CAD CAM | Angulated Screw Channel



The angulated screw channel (ASC) solution offers a transformative approach to dental restorations. ASC strategically places a screw access hole at an angle within the prosthesis, optimizing both function and esthetics.

By integrating digital planning and specialized drivers, ASC enhances accuracy and predictability in implant-supported restorations. This approach signifies a significant advancement in dental care, prioritizing esthetics and functionality to ensure patient satisfaction.

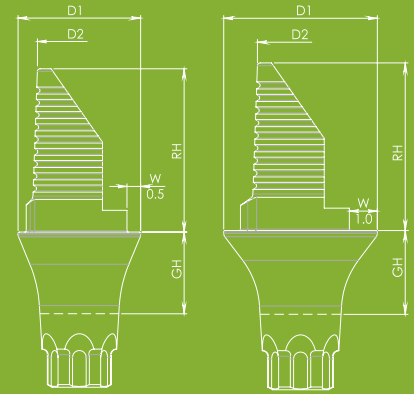
Adin's angulated screw channel Ti bases support gingival heights of 1-3mm for every each implant platform and allow for angulation of up to 20 degrees.



Ti Base Abutment Angular

	RH	GH	D1	D2	Catalog No.		RH	GH	D1	D2	Catalog No.
 <p>Ti Base Abutment Angular Engaged</p>	4.0	1.0	4.5	3.2	TB07413	 <p>Ti Base Abutment Angular Engaged Wide</p>	4.0	1.0	5.5	3.2	TB07413W
	4.0	2.0	4.5	3.2	TB07423		4.0	2.0	5.5	3.2	TB07423W
	4.0	3.0	4.5	3.2	TB07433		4.0	3.0	5.5	3.2	TB07433W
	6.0	1.0	4.5	3.1	TB07613		6.0	1.0	5.5	3.1	TB07613W
	6.0	2.0	4.5	3.1	TB07623		6.0	2.0	5.5	3.1	TB07623W
	6.0	3.0	4.5	3.1	TB07633		6.0	3.0	5.5	3.1	TB07633W
	8.0	1.0	4.5	2.9	TB07813		8.0	1.0	5.5	2.9	TB07813W
	8.0	2.0	4.5	2.9	TB07823		8.0	2.0	5.5	2.9	TB07823W
	8.0	3.0	4.5	2.9	TB07833		8.0	3.0	5.5	2.9	TB07833W
	Abutments are supplied with UF0001 screw. Recommended torque 30-35Ncm. Also available separately.										UF0001

	Description	L	L2	D1	D2	Catalog No.
	Angulated Screw Extractor Hand Driver	24.7	10	1.4	9.4	RP6400
	Angulated Star Screw Hand Driver - Short 23.4L	23.4	9.0	1.4	9.4	RP6401
	Angulated Star Screw Hand Driver - Long 28.4L	28.4	14.0	1.4	9.4	RP6402
	Angulated Star Screw Torque Driver - Short 17.0L	17.0	11.0	1.4	7.0	RP6403
	Angulated Star Screw Torque Driver - Long 22.0L	22.0	16.0	1.4	7.0	RP6404
	Angulated Star Screw Handpiece Driver - Extra Short 20.0L	20.0	7.0	1.4	2.35	RP6405
	Angulated Star Screw Handpiece Driver - Short 25.0L	25.0	12.0	1.4	2.35	RP6406
	Angulated Star Screw Handpiece Driver - Long 30.0L	30.0	17.0	1.4	2.35	RP6407



Digital Analogs

	Description	L	D1	Catalog No.		Description	Catalog No.		Description	L	D1	Catalog No.
	UniFit Digital Model Analog	10.0	3.55	UF1000		Retaining Screw	RS1002		UniFit Implant Analog	12.6	3.6	UF0007



Screws

	Description	Catalog No.
	UniFit Abutment Screw M1.6	UF0001

TMA - Multi Unit Screws

	Description	Catalog No.
	TMA Scan Body Screw	TM0001
	TMA Prosthetic Screw	RS3404

STMA / TMA Scan Bodies | For Intra-oral and Desktop Scanner

	Description	L	D1	Catalog No.		Description	L	D1	Catalog No.
	Single TMA Scan Body	6.0	4.9	TM0006S		TMA Scan Body	6.0	4.9	TM0006
		9.0	4.9	TM0009S			9.0	4.9	TM0009

STMA / TMA Cementing Cone & Temporary Cylinder

	Description	L	D1	D2	H	Catalog No.		Description	L	D1	D2	Catalog No.
	Single TMA Titanium Temporary	12.0	4.9	3.5	10.5	RS4900S		Single TMA Cementing Cone, low profile	4.9	5.5	3.2	TM0011S
	TMA Titanium Temporary	12.0	4.9	3.5	10.5	RS4900		TMA Cementing Cone, low profile	4.9	5.5	3.2	TM0011
								TMA Cementing Cone	4.9	4.9	3.8	TM0010

	Description	L	Catalog No.		Description	L	Catalog No.
	Star Hand Driver Short	23.4	RP0064		Star Hand Driver Long	28.4	RP0004

TMA™ - Multi Unit Recommended Torque 35(Ncm)

Our TMA™ (Trans Mucosal Abutment) system is indicated for multiple-unit, screw-retained restorations, and may be used in combination with an implant-level framework design.

- Elevates restorative seating platform when implant-level restoration is not practical
- Provides better access when using implants with divergent angles
- Accommodates full and partial edentulous arches
- Available in straight or angled (17°, 30°, 45°) with different gingival heights
- Abutments are delivered with handles for easy insertion and seating



		Description	GH	Catalog No.
		UniFit Straight Trans Mucosal Abutment 1mm	1.0	UF0032
		UniFit Straight Trans Mucosal Abutment 2mm	2.0	UF0033
		UniFit Straight Trans Mucosal Abutment 3mm	3.0	UF0034
		UniFit Straight Trans Mucosal Abutment 4mm	4.0	UF3729
		UniFit Straight Trans Mucosal Abutment 5mm	5.0	UF3730
		UniFit Angled Trans Mucosal Abutment 17° 1.5mm	1.5	UF3732
		UniFit Angled Trans Mucosal Abutment 17° 2.5mm	2.5	UF3734
		UniFit Angled Trans Mucosal Abutment 17° 3.5mm	3.5	UF3737
		UniFit Angled Trans Mucosal Abutment 17° 4.5mm	4.5	UF3739
		UniFit Angled Trans Mucosal Abutment 30° 1mm	1.0	UF3726
		UniFit Angled Trans Mucosal Abutment 30° 2mm	2.0	UF3727
		UniFit Angled Trans Mucosal Abutment 30° 3mm	3.0	UF3735
		UniFit Angled Trans Mucosal Abutment 30° 4mm	4.0	UF3738

Transfers

	Description	L	D1	D2	Catalog No.
	TMA Impression Coping Open Tray	11.0	4.9	3.1	RS5006
	TMA Closed Tray Transfer	8.0	4.9	4.1	RS5011
	TMA Healing Cup	5.5	4.9	3.5	RS5005

Analogs

	Description	L	D1	D2	Catalog No.
	TMA Abutment Replica	16.8	3.35	-	RS5004
	TMA Digital Model Replica <small>Recommended torque 15(Ncm)</small>	12.0	4.9	3.8	RS1001
	Description	L	D1	Catalog No.	
	TMA Scan Body	6.0	4.9	TM0006	
		9.0	4.9	TM0009	

TMA Screw For Scan Body & Cementing Cone

	Description	Catalog No.
	TMA Scan Body Screw	TM0001

TMA Screw Temporary Cylinder & STMA Direct Option

	Description	Catalog No.
	TMA Prosthetic Screw	RS3404

Snap-On

	Description	L	D1	D2	Catalog No.		Description	Catalog No.
	TMA Snap-On Transfer	8.0	4.9	3.2	RS5012		IRIS™, Impression coping	IR0179

TMA Prosthetics

	Description	L	D1	D2	Catalog No.		Description	L	D1	D2	Catalog No.	
	TMA Titanium Temporary	12.0	4.9	3.5	10.5	RS4900		TMA Cementing Cone, low profile	4.9	5.5	3.2	TM0011
	TMA Plastic Casting Sleeve /Prosthetic Screw	12.0	4.9	3.3	10.5	RS5001		TMA Cementing Cone	4.9	5.5	2.9	TM0010

Tool Drivers | For Angled TMA/TMA Prosthetic Screws

For Angled TMA/TMA prosthetic screw

	Description	L	Catalog No.
	Star Hand Driver Short	23.4	RP0064
	Star Hand Driver Long	28.4	RP0004
	Star Torque Driver-Short	20.4	RP0065
	Star Torque Driver-Long	25.4	RP0005

For straight TMA

	Description	L	Catalog No.
	TMA Hex Torque Driver - Short	20	RS6197
	TMA Hex Torque Driver - Long	25	RS6196
	TMA Female Hand Hex Driver-Short	22.4	RS6193
	TMA Female Hand Hex Driver-Long	28.4	RS6191
	TMA Hex Handpiece Adapter-Short	20	RS6194
	TMA Hex Handpiece Adapter-Long	25	RS6195A

Overdenture Restoration

Recommended Torque 35(Ncm)



		Description	GH	RH	H	Catalog No.
		UniFit Ball Attachment 0.5mm	0.6	2.7	4.1	UF0051
		UniFit Ball Attachment 1mm	1.0	2.7	4.5	UF0052
		UniFit Ball Attachment 2mm	2.0	2.7	5.5	UF0053
		UniFit Ball Attachment 3mm	3.0	2.7	6.5	UF0054
		UniFit Ball Attachment 4mm	4.0	2.7	7.5	UF0055
		UniFit Ball Attachment 5mm	5.0	2.7	8.5	UF0056

	Description	L	Ø	Catalog No.
	Ball Attachment Replica	16.6	4.0	RS5740

	Description	L	Ø	D2	Catalog No.
	Plastic Ball Cap White (Nylon)	2.6	4.1	3.6	RS2660
	Plastic Ball Cap Pink Soft (Nylon)	2.6	4.1	3.6	RS2662
	Titanium Ball Cap	2.9	4.7	4.7	RS2670

	Description	Catalog No.
	Torque Driver for Ball Attachment	RS6090

Grip™ - Overdenture Attachment

As an addition to our wide variety of prosthetic solutions.

Implant supported overdentures are among the most practical prosthetic solutions for patients who cannot utilize fixed restorations, or as an interim solution for patients who are waiting for the osteointegration process of their newly placed implants.

The Grip™ attachment system is a versatile solution, designed to ensure maximum denture retention and stability both for maxillary and mandibular dentures. The variety of retentive caps allow dentists to choose the required retention level needed for each individual case and can easily be replaced, when needed.

The Grip™ attachment system is available for Internal Hex in a range of gingival heights, to enable a reliable, long lasting and cost-effective solution for your patients.

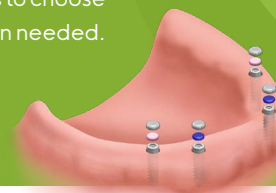
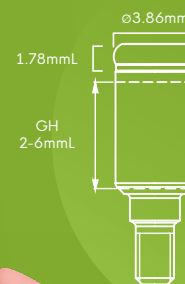

	Description	Catalog No.
	Grip UF Abutment 1mm	UF0101
	Grip UF Abutment 2mm	UF0102
	Grip UF Abutment 3mm	UF0103
	Grip UF Abutment 4mm	UF0104
	Grip UF Abutment 5mm	UF0105
	Grip UF Abutment 6mm	UF0106

	Description	Catalog No.
	Grip™ for TMA	TM0100
	Grip™ for Bar, M2 thread	RS0101

Included in Sales Pack







Grip™ Processing Set

	Description		Description	Catalog No.
	Housing		Light	RS6426
	Processing		Regular	
	Extra Light		Block Out Spacer	







Or

Grip™ Extended Range processing set

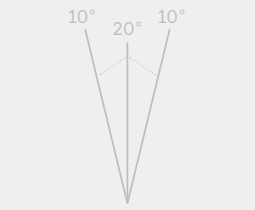
	Description		Description	Catalog No.
	Housing		Light	RS6427
	Processing		Regular	
	Zero		Block Out Spacer	
	Extra Light			

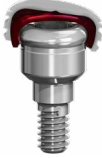
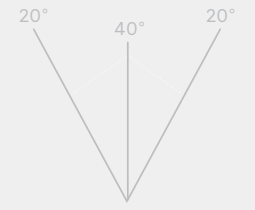

Grip Retention 4 Pack		Description	Catalog No.
			Extra Light RS6417
			Light RS6418
			Regular RS6419

Grip™ Extended Range Retention 4 Pack		Description	Catalog No.
			Zero RS6420
			Extra Light RS6421
			Light RS6422
			Regular RS6423

Grip™ Accessories

	Description	Catalog No.		Description	Catalog No.
	Grip™ Impression Coping 4 Pack Includes RS6415 Grip™ Processing 4 Pack	RS6414		Grip™ Replica 4 Pack	RS2508
	Metal Housing 4 Pack Includes RS6415 Grip™ Processing 4 Pack	RS6413		Grip™ Processing 4 Pack	RS6415
	Grip™ Block Out Spacer 4 Pack	RS6424		Grip™ Processing 20 Pack	RS6416

Grip™ Tools

	Description	Catalog No.
	Grip™ core tool	RS6200

Designed for inserting and removing the Grip™ retention males from the metal housing

	Description	Catalog No.		Description	Catalog No.		Description	Catalog No.
	Star Hand Driver Short	RP0064		1.27 Hex torque driver-long	RS6082		1.27 Hex driver for handpiece - long	RS9035
	Star Hand Driver Long	RP0004		1.27 Hex torque driver-short	RS6080		1.27 Hex driver for handpiece - short	RS9030

Surgical Kits

Successful surgical procedures start with having the right instruments and tools to ensure your desired treatment outcomes are met.

That's why our range has everything you need, including drills, keys, ratchets and insertion tools.

Not only do they make procedures safer and simpler, they result in an enhanced patient experience as well.

Our Surgical Kits streamline and simplify your implant procedures.



Premium Kit UF6301

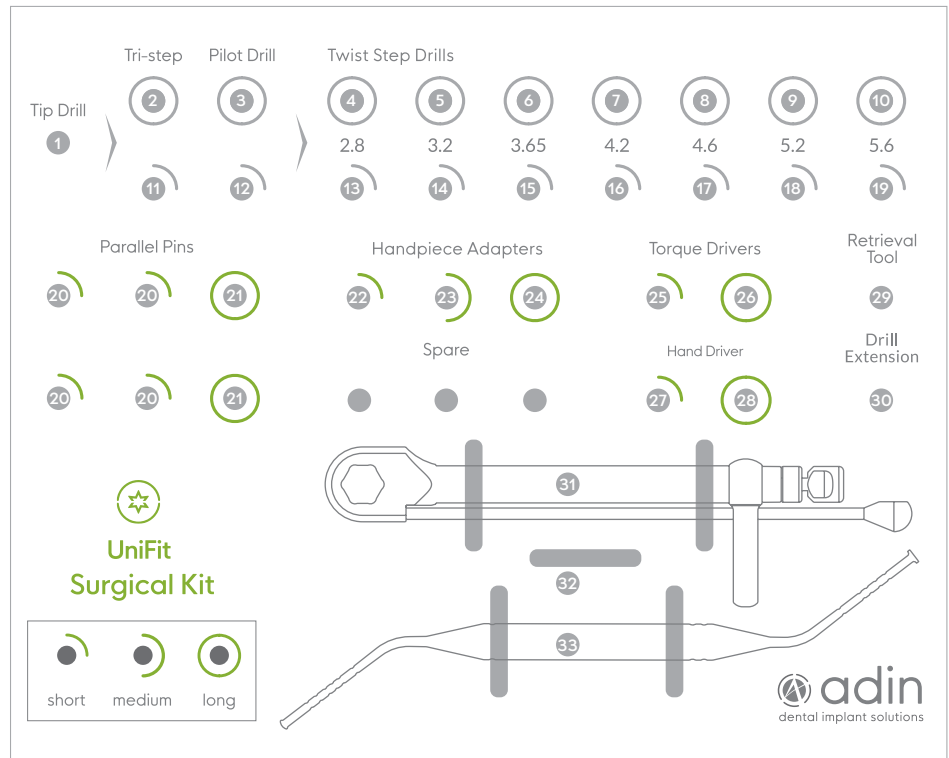

	Drills	Catalog No.
1	Tip Drill	RS8032
2	Tri-Step Drill - Long	TD2218
3	Pilot Drill 2mmD x 8-18mmL	DL1820
4	Twist Step Drill 2.3/2.8mmD x 8-18mmL	DL1828
5	Twist Step Drill 2.8/3.2mmD x 8-18mmL	DL1832
6	Twist Step Drill 3.2/3.6mmD x 8-18mmL	DL1836
7	Twist Step Drill 3.8/4.2mmD x 8-18mmL	DL1842
8	Twist Step Drill 4.2/4.6mmD x 8-18mmL	DL1846
9	Twist Step Drill 4.8/5.2mmD x 8-18mmL	DL1852
10	Twist Step Drill 5.2/5.6mmD x 8-18mmL	DL1856
11	Tri-Step Drill - Short	TD1511
12	Pilot Drill 2mmD x 6-13mmL	DL1320
13	Twist Step Drill 2.3/2.8mmDx6-13mmL	DL1328
14	Twist Step Drill 2.8/3.2mmDx6-13mmL	DL1332
15	Twist Step Drill 3.2/3.6mmDx6-13mmL	DL1336
16	Twist Step Drill 3.8/4.2mmDx6-13mmL	DL1342
17	Twist Step Drill 4.2/4.6mmDx6-13mmL	DL1346
18	Twist Step Drill 4.8/5.2mmDx6-13mmL	DL1352
19	Twist Step Drill 5.2/5.6mmDx6-13mmL	DL1356

	Parallel Pins	Catalog No.
20	Parallel Pin Short 11mm (qty. 4)	RS6150
21	Parallel Pin Short 16mm (qty. 2)	RS6155

	Insertion Tools	Catalog No.
22	UniFit Star Handpiece Adapter - Short	UF0068
23	UniFit Star Handpiece Adapter - Medium	UF0071
24	UniFit Star Handpiece Adapter - Long	UF0074

	Drivers	Catalog No.
25	UniFit Star Torque Driver - Short	UF0067
26	UniFit Star Torque Driver - Long	UF0066
27	Star Hand Driver - Short	RP0064
28	Star Hand Driver - Long	RP0004









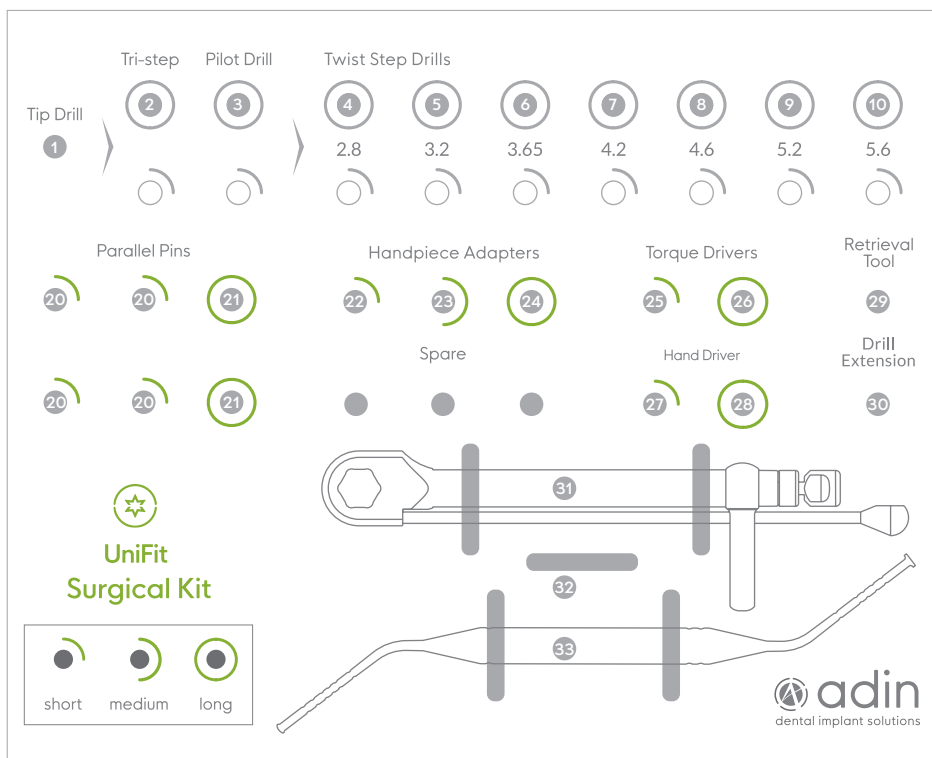

	Drill Extension	Catalog No.
29	UniFit Ratchet Retrieval tool for abutments	UF3401
30	Drill Extension	RS9027

	Surgical Tools	Catalog No.
31	Surgical Torque Ratchet 35-100 Ncm	RS6111
32	Wrench Ratchet Surgical Instruments Handle	RA0050
33	Depth Probe	RS6180



*Products may be ordered separately as an addition to the kit





Advanced Kit UF6322







	Drills	Catalog No.
1	 Tip Drill	RS8032
2	 Tri-Step Drill - Long	TD2218
3	 Pilot Drill 2mmD x 8-18mmL	DL1820
4	 Twist Step Drill 2.3/2.8mmD x 8-18mmL	DL1828
5	 Twist Step Drill 2.8/3.2mmD x 8-18mmL	DL1832
6	 Twist Step Drill 3.2/3.6mmD x 8-18mmL	DL1836
7	 Twist Step Drill 3.8/4.2mmD x 8-18mmL	DL1842
8	 Twist Step Drill 4.2/4.6mmD x 8-18mmL	DL1846
9	 Twist Step Drill 4.8/5.2mmD x 8-18mmL	DL1852
10	 Twist Step Drill 5.2/5.6mmD x 8-18mmL	DL1856

	Parallel Pins	Catalog No.
20	 Parallel Pin Short 11mm (qty. 4)	RS6150
21	 Parallel Pin Short 16mm (qty. 2)	RS6155

	Insertion Tools	Catalog No.
22	 UniFit Star Handpiece Adapter - Short	UF0068
23	 UniFit Star Handpiece Adapter - Medium	UF0071
24	 UniFit Star Handpiece Adapter - Long	UF0074

	Drivers	Catalog No.
25	 UniFit Star Torque Driver - Short	UF0067
26	 UniFit Star Torque Driver - Long	UF0066
27	 Star Hand Driver - Short	RP0064
28	 Star Hand Driver - Long	RP0004

	Drill Extension	Catalog No.
29	 UniFit Ratchet Retrieval tool for abutments	UF3401
30	 Drill Extension	RS9027

	Surgical Tools	Catalog No.
31	 Surgical Torque Ratchet 35-100 Ncm	RS6111
32	 Wrench Ratchet Surgical Instruments Handle	RA0050
33	 Depth Probe	RS6180

*Products may be ordered separately as an addition to the kit

Drills and Tools

Our DLC (Diamond-like Carbon) Tri-Step/Twist Step Surgical Drills are designed for a simpler, faster, and safer surgical drilling experience.

Here are the benefits:

Simplify the cutting process, save time, and minimize risks with our Tri-Step & Twist-Step DLC drills.

Improved DLC drill coating provides state-of-the-art hardness and slickness, increasing the lifespan of the drill, maintaining sharpness for extended drilling, and generating less heat. This reduces the chances of heating the bone or complications arising from conventional drilling protocols.

Available in diameters ranging from 2.0 mm to 5.6 mm.

Specially designed for Adin's implants and suitable for Adin's simple and convenient drilling protocol.

Clearly and conveniently marked and can be used with or without drill stops.



Tri-Step drills









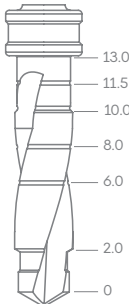

Adin's Tri-Step Drills condense drilling protocols and avoid the need for multiple drills throughout complex procedures.

Since friction at the cutting site is reduced, complications common with high-speed drilling are decreased and faster & better recovery can occur.









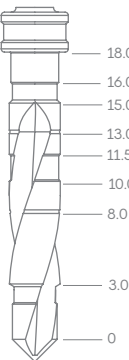

The drills are designed to reduce friction at the cutting site, therefore leading to a decrease in complications that are often associated with high-speed drilling. This can result in a faster and more efficient recovery for patients.

L		Ø	Size	Catalog No.
		1.8-3.2	Short	TD1511
		1.8-3.2	Long	TD2218

Short 6-13mm





L		Ø	Color	Catalog No.
		2.0	White	DL1320
		1.8-2.5	Purple	DL1325
		2.3-2.8	Red	DL1328
		2.8-3.2	Blue	DL1332
		3.2-3.6	Green	DL1336
		3.9	Pink	DL1339
		3.8-4.2	Black	DL1342
		4.2-4.6	Yellow	DL1346
		4.8-5.2	Brown	DL1352
		5.2-5.6	Grey	DL1356

Long 8-18mm









L		Ø	Color	Catalog No.
		2.0	White	DL1820
		1.8-2.5	Purple	DL1825
		2.3-2.8	Red	DL1828
		2.8-3.2	Blue	DL1832
		3.2-3.6	Green	DL1836
		3.9	Pink	DL1839
		3.8-4.2	Black	DL1842
		4.2-4.6	Yellow	DL1846
		4.8-5.2	Brown	DL1852
		5.2-5.6	Grey	DL1856

Surgical Tools



	Description	Catalog No.
	Surgical Torque Ratchet 35-100 Ncm	RS6111
	Wrench Ratchet	RS6100
	Surgical Driver	RS7001
	Depth Probe	RS6180

Tools







	Description	Catalog No.
	Wrench Ratchet Surgical Instruments Handle 17mm	RA0050
	Drill Extension	RS9027
	Parallel Pin 11mm	RS6150
	Parallel Pin 16mm	RS6155
	UniFit Star Handpiece Adapter - Short	UF0068
	UniFit Star Handpiece Adapter - Medium	UF0071
	UniFit Star Handpiece Adapter - Long	UF0074
	UniFit Star Torque Driver Short	UF0067
	UniFit Star Torque Driver Long	UF0066

Prosthetic Tools







Ratchet





	Description	Catalog No.
	Prosthetic Torque Ratchet 15-35 Ncm	RS6112

	1.27 Hex Torque Driver 20.4mm	RS6080
	1.27 Hex Torque Driver 25.4mm	RS6082
	TMA/FC Hex Torque Driver 25mm *For straight TMA/Flat connection	RS6196
	TMA/FC Hex Torque Driver 20mm *For straight TMA/Flat connection	RS6197
	Star Torque Driver 20.4mm *For Angled TMA/TMA prosthetic screw	RP0065
	Star Torque Driver 25.4mm *For Angled TMA/TMA prosthetic screw	RP0005
	Torque Driver for Ball Attachment 14.4mm	RS6090

Handpiece

	Description	Catalog No.
	Star Handpiece Driver - Short *For angled TMA/TMA prosthetic screws	RP0018
	Star Handpiece Driver - Long *For angled TMA/TMA prosthetic screws	RP0019
	TMA/FC Hex Handpiece Adapter 25mm *For straight TMA/Flat connection	RS6195A
	TMA/FC Hex Handpiece Adapter 20mm *For straight TMA/Flat connection	RS6194

Hand Drivers

	Description	Catalog No.
	TMA/FC Female Hand Hex Driver 28.4mm *For straight TMA/Flat connection	RS6191
	TMA/FC Female Hand Hex Driver 22.4mm *For straight TMA/Flat connection	RS6193
	Star Hand Driver 23.4mm *For Angled TMA/TMA prosthetic screw	RP0064
	Star Hand Driver 28.4mm *For Angled TMA/TMA prosthetic screw	RP0004

Retrieval Screw

	Description	Catalog No.
	UniFit Ratchet Retrieval Tool for Abutments	UF3401

Guided Surgery

Introducing the adinguide™: a guided surgery tool designed to enhance your clinic.

Our kits are tailored to support effortless and precise implant placement. With our proprietary ActiveFlow™ Irrigation technology, where coolant is efficiently delivered to the bone, preventing overheating.

The adinguide™ drills feature carved channels for direct coolant flow from your hand-piece to the osteotomy site. Our intuitive drill kit accommodates different implant sizes and lengths, while the tissue punch and pilot drill allow flapless access.



The keyless procedure offers easy handling and clear visibility of the surgical site.

Our self-centering drills utilize a diameter cylinder at the top to ensure accurate positioning within the guide's sleeve. Additionally, built-in stoppers guarantee precise and consistent drilling depths.

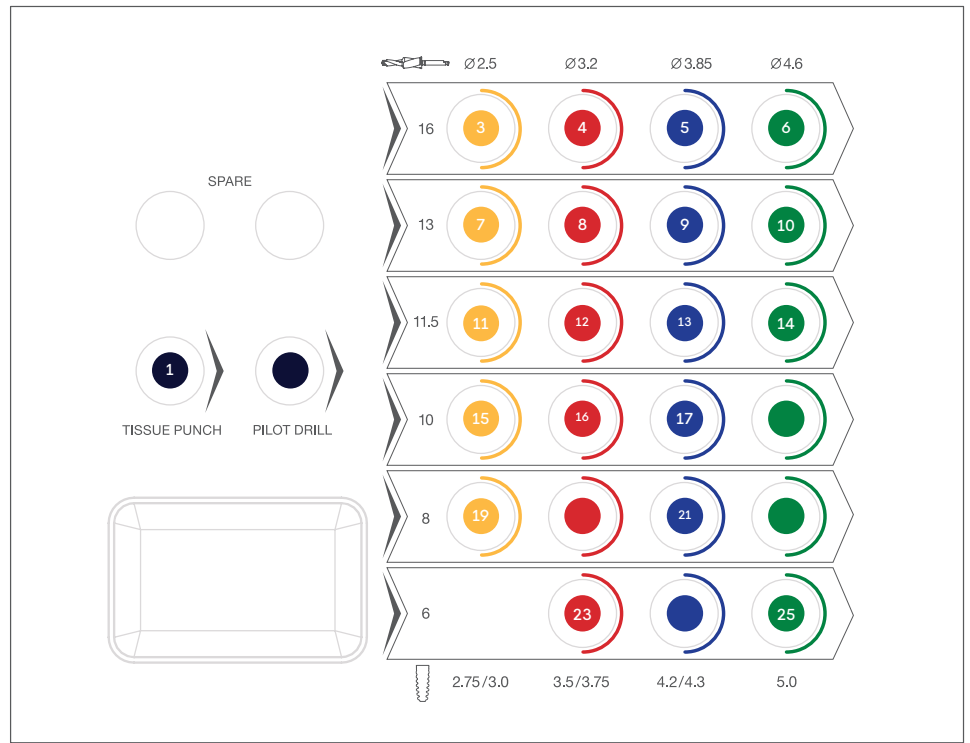

Guided Surgery Kit Implants Drills GSK001



	Drills	Catalog No.		Drills	Catalog No.		
1		Tissue Punch 5.0mmD, S-5.5	GS5055	5		Drill S-5.5, 3.85/3.2mmDx6.25mmL	GS0638
2		Pilot Drill S-5.5, 2.5/1.8mmDx6.0mmL	GS0625	9		Drill S-5.5, 3.85/3.2mmDx8.0mmL	GS0838
3		Drill S-5.5, 2.5/1.8mmDx8.0mmL	GS0825	13		Drill S-5.5, 3.85/3.2mmDx10.0mmL	GS1038
7		Drill S-5.5, 2.5/1.8mmDx10.0mmL	GS1025	17		Drill S-5.5, 3.85/3.2mmDx11.5mmL	GS1138
11		Drill S-5.5, 2.5/1.8mmDx11.5mmL	GS1125	21		Drill S-5.5, 3.85/3.2mmDx13.0mmL	GS1338
15		Drill S-5.5, 2.5/1.8mmDx13.0mmL	GS1325	24		Drill S-5.5, 3.85/3.2mmDx16.0mmL	GS1638
19		Drill S-5.5, 2.5/1.8mmDx16.0mmL	GS1625	6		Drill S-5.5, 4.6/3.85mmDx6.25mmL	GS0646
4		Drill S-5.5, 3.2/2.5mmDx6.25mmL	GS0632	10		Drill S-5.5, 4.6/3.85mmDx8.0mmL	GS0846
8		Drill S-5.5, 3.2/2.5mmDx8.0mmL	GS0832	14		Drill S-5.5, 4.6/3.85mmDx10.0mmL	GS1046
12		Drill S-5.5, 3.2/2.5mmDx10.0mmL	GS1032	18		Drill S-5.5, 4.6/3.85mmDx11.5mmL	GS1146
16		Drill S-5.5, 3.2/2.5mmDx11.5mmL	GS1132	22		Drill S-5.5, 4.6/3.85mmDx13.0mmL	GS1346
20		Drill S-5.5, 3.2/2.5mmDx13.0mmL	GS1332	25		Drill S-5.5, 4.6/3.85mmDx16.0mmL	GS1646
23		Drill S-5.5, 3.2/2.5mmDx16.0mmL	GS1632				



For full
guided
procedure:

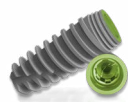

Unified Conical
Implant Platform



GS Tools Kit UniFit
GSK005



5.5mmD Sleeve
GS0055

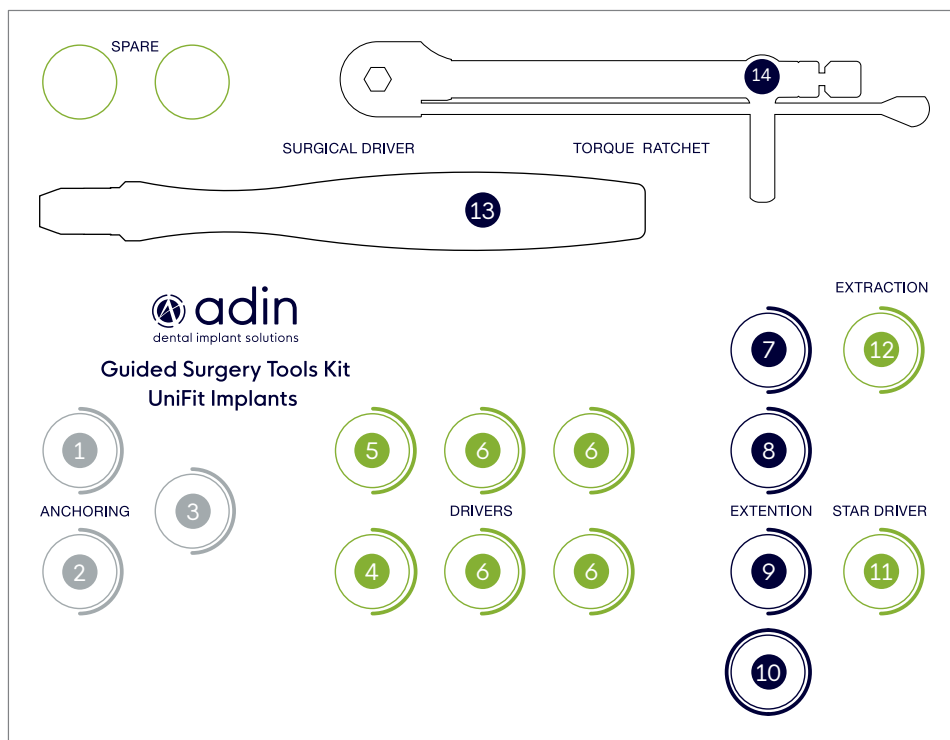

	Description	Catalog No.
1	 Anchoring Drill S-2.0, 2.0/1.5mmDx19mmL	GS1915
2	 Anchoring Drill S-2.0, 2.0/1.7mmDx19mmL	GS1917
3	 Handpiece Guide Fixation Screw Driver	GS0028
4	 Guided UniFit Handpiece Fixture Mount S-5.5	GS5041
5	 Guided UniFit Ratchet Fixture Mount S-5.5	GS5043
6	 Guided UniFit Ratchet Fixture Mount S-5.5, Screw Retained (qty.4)	GS5037
7	 Manual Socket L10.5	GS0023
8	 Manual Socket L14.5	GS0024
9	 Handpiece Socket L10.5	GS0021
10	 Handpiece Socket L14.5	GS0022
11	 Star Hand Driver - Long	RP0004
12	 UniFit Ratchet Retrieval Tool	GS5046
13	 Guide Fixation Screw Driver (Surgical Driver)	GS0027
14	 Surgical Torque Ratchet 35-100 Ncm for hex 4mm	GS6111







For full guided procedure:



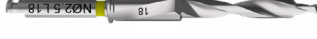

18mm Drills

	Description	Catalog No.
	Drill S-5.5, 2.5/1.8mmDx18.0mmL	GS1825
	Drill S-5.5, 3.2/2.5mmDx18.0mmL	GS1832
	Drill S-5.5, 3.85/3.2mmDx18.0mmL	GS1838
	Drill S-5.5, 4.6/3.85mmDx18.0mmL	GS1846
	Drill S-3.3, 2.5/1.8mmDx18.0mmL	GSN1825

Accessories

	Guided Vertical Fixation Screw S-5.5	x3 pack	GS0007
	2.0mmD Anchoring Screw	x3 pack	GS1920
	2.0mmD Anchoring Sleeve	x3 pack	GS0020
	5.5mmD Sleeve	x1 pack	GS0055
		x3 pack	GS0055x3
		x10 pack	GS0055x10

* Illustrations are not to scale

* Availability of the products in some places is limited and depends on local regulations.

* For more information, please contact your local representative.





CloseFit™

Narrow Implants

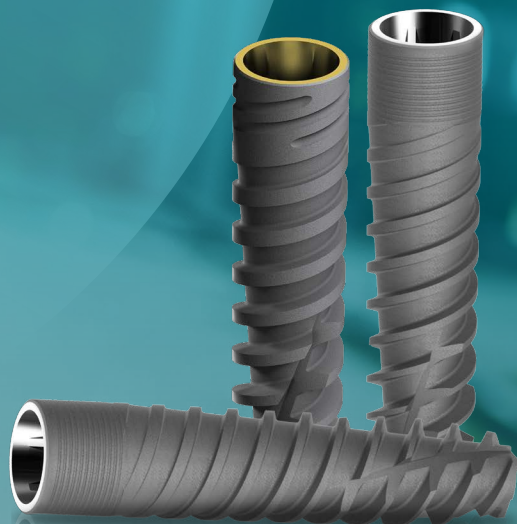

CloseFit™

Narrow Implants

When you're seeking to minimize micro-movements between the dental implant and the abutment and to reduce potential bone loss, you'll benefit from Adin's CloseFit™ spiral implant system, which features an extremely strong, stable and solid conical-hex connection.

The CloseFit's tapered core implant includes a multi-lead active & dynamic thread design. The unique design of the implant is suited for optimal repositioning at diverse angles within the lower and upper jaw. Designed for subcrestal placement up to 1.0 - 2.0mm.

The CloseFit™ implants feature Adin's OsseoFix™ - A biocompatible surface treatment that uses gritting with Calcium Phosphate media that is debris free and has been designed to achieve the desired roughness levels needed for optimal osseointegration.

With more than 10 years of proven clinical experience, these uniquely designed small diameter implants of 2.75mm & 3.0mm, have an especially narrow body & collar to provide a perfect solution that addresses narrow ridges in atrophic jaws for exceptional aesthetic results.

The strong Conical Connection is designed to minimize micro movements.

UNP CloseFit™

Ø 2.75mmD
Ultra Narrow Platform

.....
Optimally designed for narrow ridges, minimize the need for bone augmentation
.....

OsseoFix™ Surface

.....
Triple lead thread with 3.0mm (3x1mm)
For fast efficient insertion
.....

NP CloseFit™

Ø 3.0mmD
Narrow Platform

* Platform Switching

.....
*
.....
Double lead threads
2.4mm (2x1.2mm)
For fast efficient insertion
.....

* Length

L-10mm | L-11.5mm | L-13 mm
L-16mm | L-18 mm
.....

*The features related to UNP & NP Implants



Ultra Narrow Platform

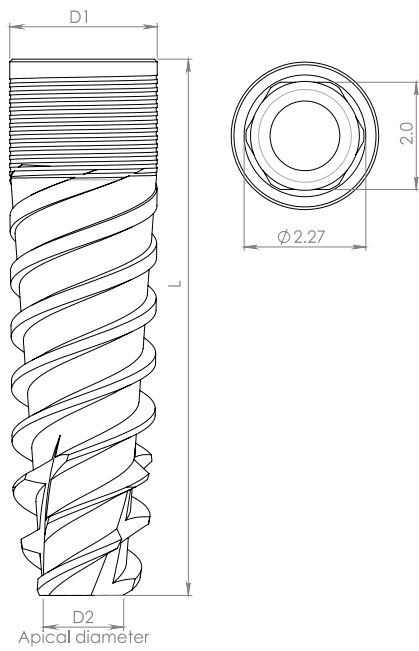

Recommended insertion torque up to 50 Ncm

	D1	L	D2	Catalog No.
	2.75	10.0	1.5	ISPUNP1027
		11.5	1.5	ISPUNP1127
		13.0	1.5	ISPUNP1327
		16.0	1.5	ISPUNP1627
		18.0	1.5	ISPUNP1827

Radiographic Template UNP CloseFit™ | ASD0615

Drill Sequence for UNP Recommended drilling speed up to 1200 rpm

Implant Diameter $\varnothing 2.75$

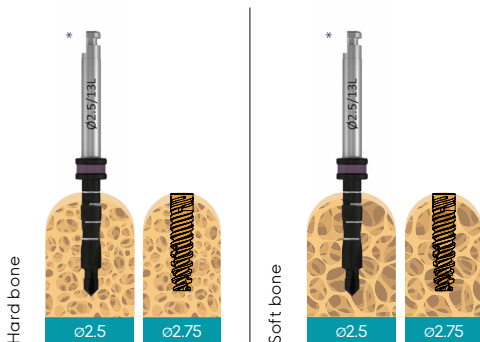

All measurements are in mm

*Products may be ordered separately as an addition to the kit

Note: (x.xx) Drill to the depth of the cortex only. All measurements are in mm.

⚠ CAUTION: The drill preparation is up to 1mm longer than the implant.

* The drill apical step = 1.8mmD.

Narrow Platform

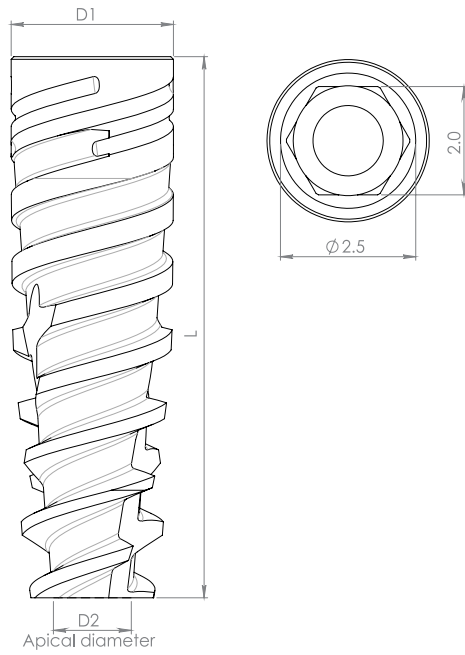

Recommended insertion torque up to 50 Ncm

	3.0	10.0	1.5	ISPNP1030
		11.5	1.5	ISPNP1130
		13.0	1.5	ISPNP1330
		16.0	1.5	ISPNP1630
		18.0	1.5	ISPNP1830

Radiographic Template NP CloseFit™ | ASD0611

Drill Sequence for NP Recommended drilling speed up to 1200 rpm

Implant Diameter $\varnothing 3.0$ $\varnothing 3.0$

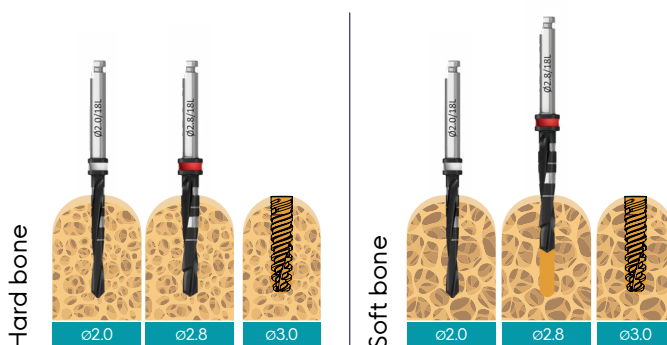

All measurements are in mm.

Note: (x.xx) Drill to the depth of the cortex only.



CAUTION: The drill preparation is up to 1mm longer than the implant. * The drill apical step = 1.8mmD.

Cover Screw & Healing Abutments



Recommended Torque 15(Ncm)

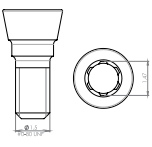

Cover Screw Packed with implant

		Description	Catalog No.
		UNP CloseFit™ Conical Cover Screw	UNP0073
		NP CloseFit™ Conical Cover Screw	NP0073

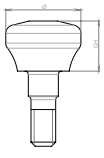
Healing Abutments

		Description	∅	GH	Catalog No.
		UNP CloseFit™ Slim Healing Abutment	2.75	2.0	UNP0046
			2.75	3.0	UNP0047
			2.75	4.0	UNP0048
			2.75	5.0	UNP0049
			2.75	6.0	UNP0050
		UNP CloseFit™ Healing Abutment	4.0	2.0	UNP0004
			4.0	3.0	UNP0008
			4.0	4.0	UNP0009
			4.0	5.0	UNP0012
			4.0	6.0	UNP0013
		UNP CloseFit™ Conical Healing Abutment	4.0	2.0	UNP0090
			4.0	3.0	UNP0091
			4.0	4.0	UNP0092
			4.0	5.0	UNP0093
			4.0	6.0	UNP0094
		NP CloseFit™ Slim Healing Abutment	3.0	2.0	NP0046
			3.0	3.0	NP0047
			3.0	4.0	NP0048
			3.0	5.0	NP0049
			3.0	6.0	NP0050
		NP Wide Healing Abutment	4.5	2.0	NP0004
			4.5	3.0	NP0008
			4.5	4.0	NP0009
			4.5	5.0	NP0012
			4.5	6.0	NP0013
		NP Conical Healing Abutment	4.5	2.0	NP0090
			4.5	3.0	NP0091
			4.5	4.0	NP0092
			4.5	5.0	NP0093
			4.5	6.0	NP0094

Impression Recommended Torque 15(Ncm)

Our components for taking impressions for all restoration types can be successfully utilized for digital or conventional protocols either implant-level or abutment level procedures.

Our broad range of solutions and flexible designs enable easy and accurate restorative planning, whether you're dealing with a single tooth, multiple teeth, bridge or full mouth rehabilitation.



UNP Transfers | Recommended Torque 15(Ncm)

	Open Tray	Description	L	D1	H	Catalog No.		Close Tray	Description	L	D1	H	Catalog No.
		UNP Open Tray Transfer Short	20.0	6.0	12.0	UNP5613			UNP Close Tray Transfer Short	11.0	3.2	9.0	UNP5711
		UNP Open Tray Transfer Long	23.5	6.0	15.0	UNP5617			UNP Close Tray Transfer Long	15.0	3.2	13.0	UNP5715

NP Transfers | Recommended Torque 15(Ncm)

	Open Tray	Description	L	D1	H	Catalog No.		Close Tray	Description	L	D1	H	Catalog No.
		NP Open Tray Transfer Short	20.0	6.0	12.0	NP5411			NP Close Tray Transfer Short	10.7	3.5	9.0	NP5311
		NP Open Tray Transfer Long	23.4	6.0	15.0	NP5415			NP Close Tray Transfer Long	15.0	3.5	13.0	NP5315

UNP Scan Bodies

	Description	H	Catalog No.		Description	H	Catalog No.
	UNP Scan Body	7	UNP0088		UNP Scan Body	10	UNP0089

NP Scan Bodies

	Description	H	Catalog No.		Description	H	Catalog No.
	NP Scan Body	7	NP0088		NP Scan Body	10	NP0089

	Description	L	D1	Catalog No.		Description	Catalog No.		Description	L	D1	Catalog No.
	UNP Digital Analog 15(Ncm)	10.0	3.55	UNP1000		Retaining Screw	RS1002		UNP Implant Analog	12.6	3.6	UNP0007

NP Analogs

	Description	L	D1	Catalog No.		Description	Catalog No.		Description	L	D1	Catalog No.
	NP Digital Analog 15(Ncm)	10.0	3.55	NP1000		Retaining Screw	RS1002		NP Implant Analog	12.6	3.6	NP0007

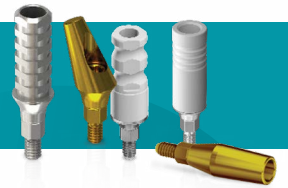

Temporary & Cement Retained Restoration

Recommended Torque 35(Ncm)



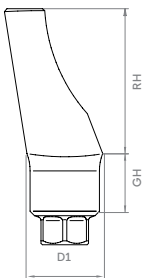

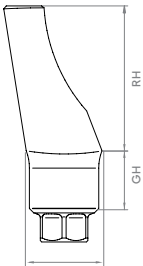





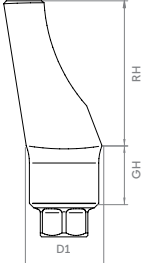

	Description	D1	GH	RH	Catalog No.
	UNP Non Engaging Temporary Abutment	3.70	2.00	8.00	UNP0044
	UNP Engaging Temporary Abutment	3.70	2.00	8.00	UNP0043
	UNP Straight Slim Abutment No End Line	3.50	1.00	7.30	UNP0010
	UNP Straight Abutment	4.20	1.00	6.50	UNP0019
		4.20	2.00	6.50	UNP0011
		4.20	3.00	6.50	UNP0064
	UNP Angled Abutment 15° No End Line	3.50	1.00	6.10	UNP0018
	UNP Angled Abutment 15°	4.20	1.00	6.50	UNP0063
		4.20	2.00	6.50	UNP0015
		4.20	3.00	6.50	UNP0026
	UNP One Piece Screw in Abutment	3.50	1.10	9.30	UNP3812
		3.50	2.00	9.30	UNP3813
		3.50	3.00	9.30	UNP3814
	UNP Engaging Plastic Cylinder Abutment	3.70	2.00	8.00	UNP0045



		Description	D1	GH	RH	Catalog No.
		UNP Engaging Cobalt Chrome/ Plastic Abutment	3.70	2.00	8.00	UNP3094
		UNP Non-Engaging Cobalt Chrome/ Plastic Abutment	3.70	2.00	8.00	UNP3100

NP Abutments

		Description	D1	GH	RH	Catalog No.
		NP Engaging Temporary Abutment	3.7	0.7	8.0	NP0043
		NP Non-Engaging Temporary Abutment	3.7	0.7	8.0	NP0044
		NP Straight Slim Abutment No End Line	3.5	3.2	5.7	NP0010
		NP Straight Abutment	4.4	1.0	6.5	NP0019
			4.4	2.0	6.5	NP0011
			4.4	3.0	6.5	NP0064
		NP Angled Abutment 15° No End Line	4.3	1.4	8.2	NP0018
		NP Angled Abutment 15°	4.8	1.0	6.5	NP0015
			4.8	2.0	6.5	NP0026
			4.8	3.0	6.5	NP0063
		NP Angled Abutment 25° No End Line	3.8	1.6	6.5	NP0025
		NP Engaging Plastic Cylinder Abutment (Casting)	3.7	0.7	8.0	NP0045
		NP Engaging Cobalt Chrome/ Plastic Abutment	4.2	1.0	10.0	NP3094
	NP Engaging Titanium/ Plastic Abutment (Casting)	4.2	1.0	10.0	NP3095	
	NP Non-Engaging Titanium / Plastic Abutment (Casting)	4.2	1.0	10.0	NP3097	

Iris™ Snap - on for UNP and NP

Adin's Snap-on impression is an effective and easy option for both implant level and abutment level impression copying. Plastic pickup cap placed over a precision machined abutment allows for accurate coping utilizing closed tray impression. Adin's Snap-on range aims to allow flexibility by offering various options to match users preferred method of use through pre packed kits:

- IRIS™ Kit - abutment level impression and restoration set
- Snap-on impression kit - implant level impression



UNP Iris™ Kit



Description	RH	GH	Catalog No.
Iris™ UNP CloseFit™ Kit	4	1	IR6041
		2	IR6042
		3	IR6043
		4	IR6044
	6	1	IR6061
		2	IR6062
		3	IR6061
		4	IR6062
	8	1	IR6063
		2	IR6064
		3	IR6081
		4	IR6082

UNP Snap-on Impression Kit



Description	RH	GH	Catalog No.
Iris™ UNP Snap-on Impression Kit	4	1	IR6141
		2	IR6142
		3	IR6143
		4	IR6144
	6	2	IR6262
		4	IR6264



Description	RH	GH	Catalog No.
Iris™ UNP Abutment	4	1	IR0641
		2	IR0642
		3	IR0643
		4	IR0644
	6	1	IR0661
		2	IR0662
		3	IR0663
		4	IR0664
	8	1	IR0681
		2	IR0682

NP Iris™ Kit



Iris™ NP CloseFit™ Kit	4	1	IR2041
		2	IR2042
		3	IR2043
		4	IR2044
	6	1	IR2061
		2	IR2062
		3	IR2063
		4	IR2064
	8	1	IR2081
		2	IR2082

NP Snap-on Impression Kit







Description	RH	GH	Catalog No.
Iris™ NP Snap-on Impression Kit	4	1	IR2141
		2	IR2142
		3	IR2143
		4	IR2144
	6	2	IR2262
		4	IR2264



NP Snap-on Impression Pack



Description	RH	GH	Catalog No.
Iris™ NP Abutment	4	1	IR0241
		2	IR0242
		3	IR0243
		4	IR0244
	6	1	IR0261
		2	IR0262
		3	IR0263
		4	IR0264
	8	1	IR0281
		2	IR0282

Purchase Options

	Description	RH	Catalog No.
	UNP Implant Analog	-	UNP0007
	NP Implant Analog	-	NP0007
	Iris™ Abutment replica	4	IR0404
		6	IR0406
		8	IR0408
	Iris™ PEEK Comfort cap	4	IR0180
		6	IR0181
		8	IR0189



	Description	Qty	Catalog No.
	Iris™, Burnout anti rotation cap red	1	IR0182
		4	IR0185
	Iris™, Burnout cap white	4	IR0183
		6	IR0186
	Iris™, Impression coping	1	IR0179
		4	IR0184

Narrow Screw - Retained











Recommended Torque 35(Ncm)



UNP Screws

	Description	L	Ø	Catalog No.
	UNP Abutment Screw	7.90	2.00	UNP0001
	UNP Closed Tray Transfer Screw	20.00	2.80	UNP5127
	UNP Open Tray Transfer Screw	28.00	3.10	UNP5014

NP Screws

	Description	L	Ø	Catalog No.
	NP Abutment Screw	7.9	2.0	NP0001
	TMA Prosthetic Screw 15(Ncm)	4.1	2.1	RS3404
	NP Retaining Screw for Angled TMA	7.1	2.0	NP0042
	NP Retaining Screw for TMA 1mm	8.0	3.1	NP0039
	NP Retaining Screw for TMA 2mm	9.0	3.1	NP0040
	NP Retaining Screw for TMA 3mm	10.0	3.1	NP0041
	NP Retaining Screw for TMA 4mm	11.0	3.1	NP3409
	NP Retaining Screw for TMA 5mm	12.0	3.1	NP3412
	NP Open Tray Transfer Screw	28.0	3.1	NP5014
	NP Closed Tray Transfer Screw	20.0	2.8	NP5127
	NP Retrieval Screw for Abutments	13.4	2.0	NP0014

NP Single TMA™ Recommended Torque 35(Ncm)

Adding to Adin's variety of the screw-retained restoration range, in comes the single TMA. Utilizing all the benefits of the TMA abutments while allowing the accuracy and flexibility for single tooth restoration.



Adin's STMA offers the possibility to combine the benefits of trans-gingival approach and screw-retained single tooth restoration yielding greater flexibility in both esthetics, safety and restoration maintenance. Adin's Single TMA is based on the TMA abutment, while the added hex index offers both the required accurate positioning and retention to support a single tooth crown. Open and closed tray transfers as well as scan bodies for digital impression are available to match every preferred impression method as well as replicas for straight forward and simple work process.

		Description	GH	Catalog No.
		NP Straight Single TMA Abutment 1mm	1.0	NP0032S
		NP Straight Single TMA Abutment 2mm	2.0	NP0033S
		NP Straight Single TMA Abutment 3mm	3.0	NP0034S
		NP Straight Single TMA Abutment 4mm	4.0	NP3729S
		NP Straight Single TMA Abutment 5mm	5.0	NP3730S
		NP Angled Single TMA Abutment 17° 3mm	2.8	NP0035S
		NP Angled Single TMA Abutment 17° 4mm	3.9	NP0038S
		NP Angled Single TMA Abutment 30° 3.5mm	3.4	NP0036S
		NP Angled Single TMA Abutment 30° 5mm	4.9	NP0037S

Transfers

Description	L	D1	D2	Catalog No.	Description	L	D1	D2	Catalog No.
 Single TMA Impression Coping Open Tray	11.0	4.9	3.1	RS5006S	 Single TMA Closed Tray Transfer	8.0	4.9	4.1	RS5011S

Snap-On

Description	L	D1	D2	Catalog No.	Description	Catalog No.
 Single TMA Snap-On Transfer	8.0	4.9	3.2	RS5012S	 IRIS™, Impression coping	IR0179





Analogs

Description	L	D1	Catalog No.	Description	L	D1	D2	Catalog No.
 Single TMA Abutment Replica	16.8	3.35	RS5004S	 Single TMA Digital Model Replica	12.0	4.9	3.8	RS1001S

Scan Bodies

	Description	L	D1	Catalog No.
	Single TMA Scan Body	6.0	4.9	TM0006S
		9.0	4.9	TM0009S

STMA Prosthetics

	Description	L	D1	D2	H	Catalog No.
	Single TMA Titanium Temporary	12.0	4.9	3.5	10.5	RS4900S
	Single TMA Plastic Casting Sleeve w/Prosthetic Screw	12.0	4.9	3.3	10.5	RS5001S
	Single TMA Healing Cup	5.5	4.9	3.5	-	RS5005S
	Single TMA Cementing Cone, low profile	4.9	5.5	3.2	-	TM0011S





CAD CAM

Adin's CAD - CAM components and digital libraries enable clinicians and technicians to design and manufacture state-of-the-art restorations supported by Adin's implants, using current digital restoration processes.



The variety of components ensures endless restorative options for treatment of single, multiple, partially, or fully edentulous cases.







UNP

For Intra-oral and Desktop Scanner		H	Catalog No.	For Medentika PreFace® Holder		Ø	Catalog No.
	UNP Scan Body	7	UNP0088		UNP Ti Blank	11.5	UNP1711
		10	UNP0089			15.8	UNP1715



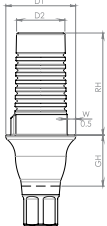

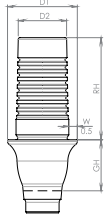
NP

For Intra-oral and Desktop Scanner		H	Catalog No.	For Medentika PreFace® Holder		Ø	Catalog No.
	UNP Scan Body	7	NP0088		NP Ti Blank	11.5	NP1111
		10	NP0089			15.8	NP1115



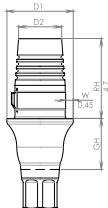

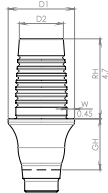
UNP Ti Base Abutments

	Description	RH	GH	D1	D2	Catalog No.
	 Ti Base UNP Abutment, Engaged	4.0	1.5	4.1	2.9	TB06411
		4.0	2.0	4.1	2.9	TB06421
		4.0	3.0	4.1	2.9	TB06431
		4.0	4.0	4.1	2.9	TB06441
		6.0	1.5	4.1	2.8	TB06611
		6.0	2.0	4.1	2.8	TB06621
		6.0	3.0	4.1	2.8	TB06631
		6.0	4.0	4.1	2.9	TB06641
		8.0	1.5	4.1	2.8	TB06811
		8.0	2.0	4.1	2.8	TB06821
	 Ti Base UNP Abutment, Non Engaged	4.0	1.5	4.1	2.9	TB06412
		4.0	2.0	4.1	2.9	TB06422
		4.0	3.0	4.1	2.9	TB06432
		4.0	4.0	4.1	2.9	TB06442
		6.0	1.5	4.1	2.8	TB06612
		6.0	2.0	4.1	2.8	TB06622
		6.0	3.0	4.1	2.8	TB06632
		6.0	4.0	4.1	2.8	TB06642
		8.0	1.5	4.1	2.8	TB06812
		8.0	2.0	4.1	2.8	TB06822

For further product information and use please refer to IFU028

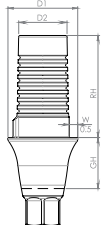

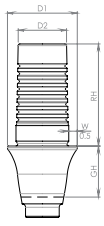

	Description	RH	GH	D1	D2	Catalog No.
	 C-Type Ti Base UNP Abutment, Engaged	4.7	1.5	3.9	2.5	TB06414
		4.7	2.0	3.9	2.5	TB06424
		4.7	3.0	3.9	2.5	TB06434
		4.7	4.0	3.9	2.5	TB06444
	 C-Type Ti Base UNP Abutment, Non Engaged	4.7	1.5	3.9	2.6	TB06415
		4.7	2.0	3.9	2.6	TB06425
		4.7	3.0	3.9	2.6	TB06435
		4.7	4.0	3.9	2.6	TB06445

NP Ti Base Abutments

	Description	RH	GH	D1	D2	Catalog No.
	 Ti Base NP Abutment,	4.0	1.5	4.1	2.9	TB02411
		4.0	2.0	4.1	2.9	TB02421
		4.0	3.0	4.1	2.9	TB02431
		4.0	4.0	4.1	2.9	TB02441
		6.0	1.5	4.1	2.8	TB02611
		6.0	2.0	4.1	2.8	TB02621
		6.0	3.0	4.1	2.8	TB02631
		6.0	4.0	4.1	2.8	TB02641
		8.0	1.5	4.1	2.8	TB02811
		8.0	2.0	4.1	2.8	TB02821
	 Ti Base NP Abutment,	4.0	1.5	4.1	2.9	TB02412
		4.0	2.0	4.1	2.9	TB02422
		4.0	3.0	4.1	2.9	TB02432
		4.0	4.0	4.1	2.9	TB02442
		6.0	1.5	4.1	2.8	TB02612
		6.0	2.0	4.1	2.8	TB02622
		6.0	3.0	4.1	2.8	TB02632
		6.0	4.0	4.1	2.8	TB02642
		8.0	1.5	4.1	2.8	TB02812
		8.0	2.0	4.1	2.8	TB02822

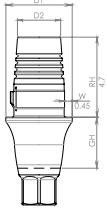
NP C-Type Ti Base Abutments

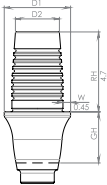
For further product information and use please refer to IFU028

	Description	RH	GH	D1	D2	Catalog No.
	 C-Type Ti Base NP Abutment, Engaged	4.7	1.5	3.9	2.5	TB02414
		4.7	2.0	3.9	2.5	TB02424
		4.7	3.0	3.9	2.5	TB02434
		4.7	4.0	3.9	2.5	TB02444
	 C-Type Ti Base NP Abutment, Non Engaged	4.7	1.5	3.9	2.6	TB02415
		4.7	2.0	3.9	2.6	TB02425
		4.7	3.0	3.9	2.6	TB02435
		4.7	4.0	3.9	2.6	TB02445

CAD CAM | Angulated Screw Channel

The angulated screw channel (ASC) solution offers a transformative approach to dental restorations. ASC strategically places a screw access hole at an angle within the prosthesis, optimizing both function and esthetics.

By integrating digital planning and specialized drivers, ASC enhances accuracy and predictability in implant-supported restorations. This approach signifies a significant advancement in dental care, prioritizing esthetics and functionality to ensure patient satisfaction.

Adin's angulated screw channel Ti bases support gingival heights of 1-3mm for every each implant platform and allow for angulation of up to 20 degrees.

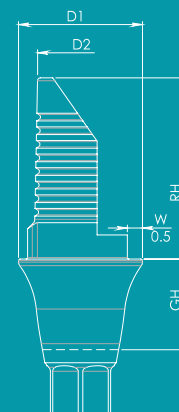

Ti Base Abutment Angular



	RH	GH	D1	D2	Catalog No.		RH	GH	D1	D2	Catalog No.
 UNP Ti Base Abutment Angular Engaged	4.0	1.5	4.1	2.9	TB06413	 NP Ti Base Abutment Angular Engaged	4.0	1.5	4.1	2.9	TB02413
	4.0	2.0	4.1	2.9	TB06423		4.0	2.0	4.1	2.9	TB02423
	4.0	3.0	4.1	2.9	TB06433		4.0	3.0	4.1	2.9	TB02433
	6.0	1.5	4.1	2.9	TB06613		6.0	1.5	4.1	2.8	TB02613
	6.0	2.0	4.1	2.9	TB06623		6.0	2.0	4.1	2.8	TB02623
	6.0	3.0	4.1	2.9	TB06633		6.0	3.0	4.1	2.8	TB02633
	8.0	1.5	4.1	2.9	TB06813		8.0	1.5	4.1	2.8	TB02813
	8.0	2.0	4.1	2.9	TB06823		8.0	2.0	4.1	2.8	TB02823
	Abutments are supplied with UNP0001 screw. Recommended torque 25Ncm. Also available separately				UNP0001		Abutments are supplied with NP0001 screw. Recommended torque 25Ncm. Also available separately				NP0001

Angulated Tools



	Angulated Screw Extractor Hand Driver	24.7	10	1.4	9.4	RP6400
	Angulated Star Screw Hand Driver - Short 23.4L	23.4	9.0	1.4	9.4	RP6401
	Angulated Star Screw Hand Driver - Long 28.4L	28.4	14.0	1.4	9.4	RP6402
	Angulated Star Screw Torque Driver - Short 17.0L	17.0	11.0	1.4	7.0	RP6403
	Angulated Star Screw Torque Driver - Long 22.0L	22.0	16.0	1.4	7.0	RP6404
	Angulated Star Screw Handpiece Driver - Extra Short 20.0L	20.0	7.0	1.4	2.35	RP6405
	Angulated Star Screw Handpiece Driver - Short 25.0L	25.0	12.0	1.4	2.35	RP6406
	Angulated Star Screw Handpiece Driver - Long 30.0L	30.0	17.0	1.4	2.35	RP6407

Digital Analogs



	Description	L	D1	Catalog No.		Description	Catalog No.		Description	L	D1	Catalog No.
	UNP CloseFit™ Digital Analog	10.0	3.55	UNP1000		Retaining Screw	RS1002		NP CloseFit™ Digital Analog	10.0	3.55	NP1000

	Description	Catalog No.
	UNP CloseFit™ Abutment Screw	UNP0001
	NP CloseFit™ Abutment Screw	NP0001





TMA - Multi Unit Screws

	Description	Catalog No.
	TMA Scan Body Screw	TM0001
	TMA Prosthetic Screw	RS3404

STMA / TMA Scan Bodies | For Intra-oral and Desktop Scanner

	Description	L	D1	Catalog No.		Description	L	D1	Catalog No.
	Single TMA Scan Body	6.0	4.9	TM0006S		TMA Scan Body	6.0	4.9	TM0006
		9.0	4.9	TM0009S			9.0	4.9	TM0009

STMA / TMA Cementing Cone & Temporary Cylinder

	Description	L	D1	D2	H	Catalog No.		Description	L	D1	D2	Catalog No.
	Single TMA Titanium Temporary	12.0	4.9	3.5	10.5	RS4900S		Single TMA Cementing Cone, low profile	4.9	5.5	3.2	TM0011S
								TMA Cementing Cone, low profile	4.9	5.5	3.2	TM0011
	TMA Titanium Temporary	12.0	4.9	3.5	10.5	RS4900		TMA Cementing Cone	4.9	4.9	3.8	TM0010

Tool Drivers

	Description	L	Catalog No.		Description	L	Catalog No.
	Star Hand Driver Short	23.4	RP0064		Star Hand Driver Long	28.4	RP0004

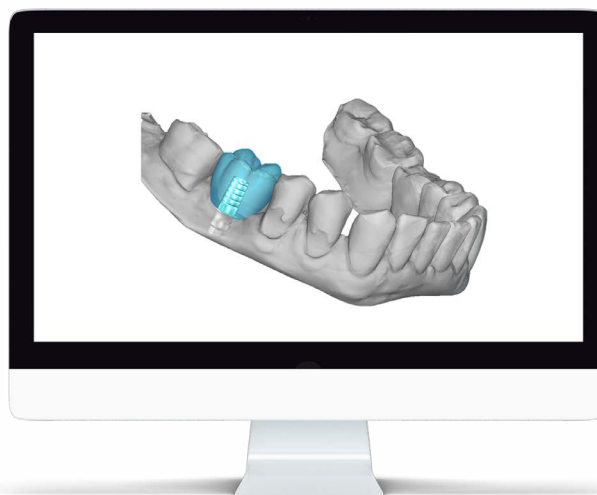

TMA™ - Multi Unit Recommended Torque 35(Ncm)

Our TMA™ (Trans Mucosal Abutment) system is indicated for multiple-unit, screw-retained restorations, and may be used in combination with an implant-level framework design.

- Elevates restorative seating platform when implant-level restoration is not practical
- Provides better access when using implants with divergent angles
- Accommodates full and partial edentulous arches
- Available in straight or angled (17°, 30°, 45°) with different gingival heights
- Abutments are delivered with handles for easy insertion and seating

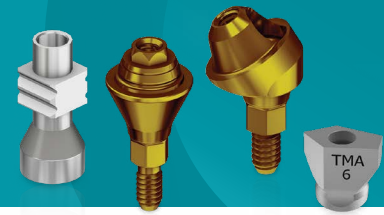

		Description	GH	Catalog No.
		NP Straight Trans Mucosal Abutment	1.0	NP0032
			2.0	NP0033
			3.0	NP0034
			4.0	NP3729
			5.0	NP3730
		NP Angled Trans Mucosal Abutment 17°	2.8	NP0035
		NP Angled Trans Mucosal Abutment 17°	3.9	NP0038
		NP Angled Trans Mucosal Abutment 30°	3.4	NP0036
		NP Angled Trans Mucosal Abutment 30°	4.9	NP0037

Transfers

	Description	L	D1	D2	Catalog No.
	TMA Impression Coping Open Tray	11.0	4.9	3.1	RS5006
	TMA Closed Tray Transfer	8.0	4.9	4.1	RS5011
	TMA Healing Cup	5.5	4.9	3.5	RS5005

Analogs

	TMA Abutment Replica	16.8	3.35	-	RS5004
	TMA Digital Model Replica <small>Recommended torque 15(Ncm)</small>	12.0	4.9	3.8	RS1001
	Description	L	D1	Catalog No.	
	TMA Scan Body	6.0	4.9	TM0006	
		9.0	4.9	TM0009	

TMA Screw For Scan Body & Cementing Cone

	Description	Catalog No.
	TMA Scan Body Screw	TM0001





TMA Screw Temporary Cylinder & STMA Direct Option

	Description	Catalog No.
	TMA Prosthetic Screw	RS3404

Snap-On

	Description	L	D1	D2	Catalog No.		Description	Catalog No.
	TMA Snap-On Transfer	8.0	4.9	3.2	RS5012		IRIS™, Impression coping	IR0179

TMA Prosthetics

	Description	L	D1	D2	H	Catalog No.		Description	L	D1	D2	Catalog No.
	TMA Titanium Temporary	12.0	4.9	3.5	10.5	RS4900		TMA Cementing Cone, low profile	4.9	5.5	3.2	TM0011
	TMA Plastic Casting Sleeve /Prosthetic Screw	12.0	4.9	3.3	10.5	RS5001		TMA Cementing Cone	4.9	5.5	2.9	TM0010

Overdenture Restoration

Recommended Torque 25(Ncm)



		Description	GH	RH	H	Catalog No.
		UNP Ball Attachment	0.6	2.45	3.05	UNP0020
			1.0	2.45	3.45	UNP0021
			2.0	2.45	4.45	UNP0022
			3.0	2.45	5.45	UNP0023
			4.0	2.45	6.45	UNP0024
			5.0	2.45	7.45	UNP0025
		NP Ball Attachment	0.6	2.7	4.1	NP0020
			1.0	2.7	4.5	NP0021
			2.0	2.7	5.5	NP0022
			3.0	2.7	6.5	NP0023
			4.0	2.7	7.5	NP0024

	Description	L	Ø	Catalog No.
	Ball Attachment Replica	16.6	4.0	RS5740

	Description	L	Ø	D2	Catalog No.
	Plastic Ball Cap White (Nylon)	2.6	4.1	3.6	RS2660
	Plastic Ball Cap Pink Soft (Nylon)	2.6	4.1	3.6	RS2662
	Titanium Ball Cap	2.9	4.7	4.7	RS2670
	Stainless Steel Ball Cap	2.90	4.70	4.70	RS2675SS

Grip™ - Overdenture Attachment

As an addition to our wide variety of prosthetic solutions.

Implant supported overdentures are among the most practical prosthetic solutions for patients who cannot utilize fixed restorations, or as an interim solution for patients who are waiting for the osseointegration process of their newly placed implants.

The Grip™ attachment system is a versatile solution, designed to ensure maximum denture retention and stability both for maxillary and mandibular dentures. The variety of retentive caps allow dentists to choose the required retention level needed for each individual case and can easily be replaced, when needed.

The Grip™ attachment system is available for Internal Hex in a range of gingival heights, to enable a reliable, long lasting and cost-effective solution for your patients.

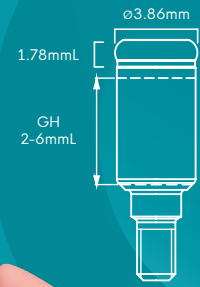

NP Grip™ Abutments

	Description	Catalog No.
	Grip NP Abutment 1mm	NP0051
	Grip NP Abutment 2mm	NP0052
	Grip NP Abutment 3mm	NP0053
	Grip NP Abutment 4mm	NP0054
	Grip NP Abutment 5mm	NP0055
	Grip NP Abutment 6mm	NP0056

	Description	Catalog No.
	Grip™ for TMA	TM0100
	Grip™ for Bar, M2 thread	RS0101

Included in Sales Pack

	Housing		Light	RS6426
	Processing		Regular	
	Extra Light		Block Out Spacer	



Or





Grip™ Extended Range processing set

	Description		Description	Catalog No.
	Housing		Light	RS6427
	Processing		Regular	
	Zero		Block Out Spacer	
	Extra Light			



Grip™ Retention Caps

Grip Retention 4 Pack		Description	Catalog No.
		Extra Light	RS6417
		Light	RS6418
		Regular	RS6419

Grip™ Extended Range Retention 4 Pack		Description	Catalog No.
		Zero	RS6420
		Extra Light	RS6421
		Light	RS6422
		Regular	RS6423



Grip™ Accosories

Description	Catalog No.	Description	Catalog No.
 <p>Grip™ Impression Coping 4 Pack Includes RS6415 Grip™ Processing 4 Pack</p>	RS6414	 <p>Grip™ Replica 4 Pack</p>	RS2508
 <p>Metal Housing 4 Pack Includes RS6415 Grip™ Processing 4 Pack</p>	RS6413		 <p>Grip™ Processing 4 Pack</p>
 <p>Grip™ Block Out Spacer 4 Pack</p>	RS6424	 <p>Grip™ Processing 20 Pack</p>	RS6416

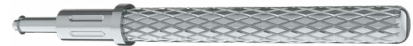
Grip™ Tools

Description	Catalog No.
 <p>Grip™ core tool</p>	RS6200

Designed for inserting and removing the Grip™ retention males from the metal housing

Description	Catalog No.	Description	Catalog No.
 <p>Star Hand Driver Short</p>	RP0064	 <p>1.27 Hex torque driver-long</p>	RS6082
 <p>Star Hand Driver Long</p>	RP0004	 <p>1.27 Hex torque driver-short</p>	RS6080
		 <p>1.27 Hex driver for handpiece - long</p>	RS9035
		 <p>1.27 Hex driver for handpiece - short</p>	RS9030

Surgical Kits

Successful surgical procedures start with having the right instruments and tools to ensure your desired treatment outcomes are met.

That's why our range has everything you need, including drills, keys, ratchets and insertion tools.









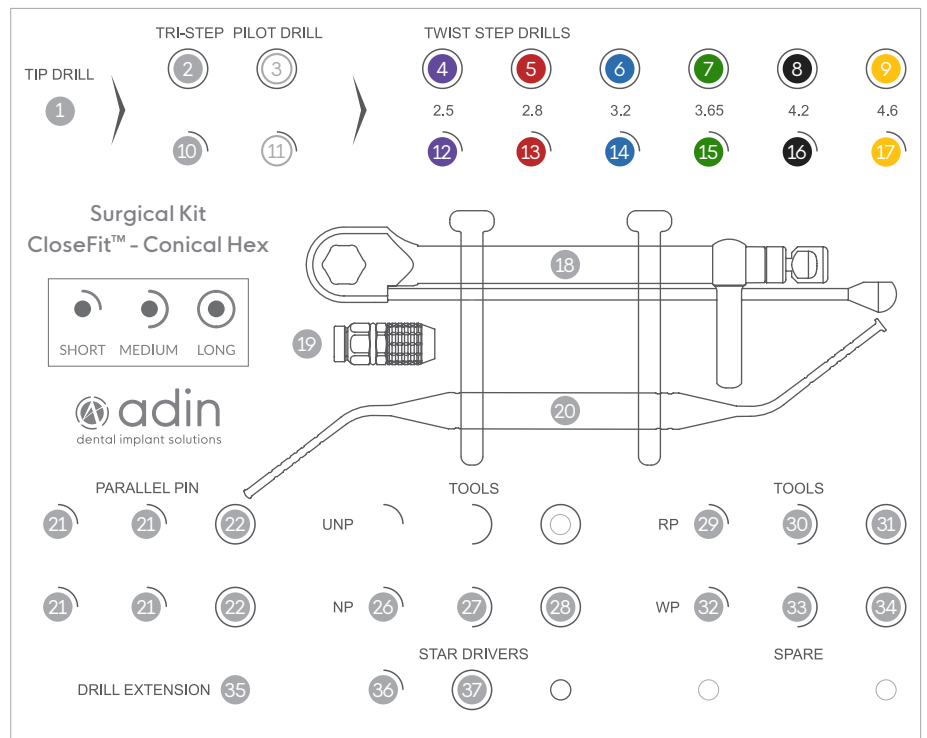

























Not only do they make procedures safer and simpler, they result in an enhanced patient experience as well.

Our Surgical Kits streamline and simplify your implant procedures.



Premium Kit CF6300



	Drills	Catalog No.		Surgical Tools	Catalog No.
1	 Tip Drill	RS8032	18	 Surgical Torque Ratchet 35-100 Ncm	RS6111
2	 Tri-Step Drill - Long	TD2218	19	 Wrench Ratchet Surgical Instruments Handle	RA0050
3	 Pilot Drill 2mmD x 8-18mmL	DL1820	20	 Depth Probe	RS6180
4	 Twist Step Drill 1.8/2.5mmD x 8-18mmL	DL1825			
5	 Twist Step Drill 2.3/2.8mmD x 8-18mmL	DL1828			
6	 Twist Step Drill 2.8/3.2mmD x 8-18mmL	DL1832			
7	 Twist Step Drill 3.2/3.6mmD x 8-18mmL	DL1836			
8	 Twist Step Drill 3.8/4.2mmD x 8-18mmL	DL1842			
9	 Twist Step Drill 4.2/4.6mmD x 8-18mmL	DL1846			
10	 Tri-Step Drill - Short	TD1511			
11	 Pilot Drill 2mmD x 6-13mmL	DL1320			
12	 Twist Step Drill 1.8/2.5mmD x 6-13mmL	DL1325			
13	 Twist Step Drill 2.3/2.8mmD x 6-13mmL	DL1328			
14	 Twist Step Drill 2.8/3.2mmD x 6-13mmL	DL1332			
15	 Twist Step Drill 3.2/3.6mmD x 6-13mmL	DL1336			
16	 Twist Step Drill 3.8/4.2mmD x 6-13mmL	DL1342			
17	 Twist Step Drill 4.2/4.6mmD x 6-13mmL	DL1346			
				Parallel Pins	Catalog No.
21	 Parallel Pin Short 11mm (qty. 4)	RS6150			
22	 Parallel Pin Short 16mm (qty. 2)	RS6155			
				Insertion Tools	Catalog No.
26	 NP 2mm Hex Handpiece Adapter - Short	NP0068			
27	 NP 2mm Hex Handpiece Adapter - Medium	NP0071			
28	 NP 2mm Hex Handpiece Adapter - Long	NP0074			
29	 RP 2.25mm Hex Handpiece Adapter - Short	RP0068			
30	 RP 2.25mm Hex Handpiece Adapter - Medium	RP0071			
31	 RP 2.25mm Hex Handpiece Adapter - Long	RP0074			
32	 WP 2.65mm Hex Handpiece Adapter - Short	WP0068			
33	 WP 2.65mm Hex Handpiece Adapter - Medium	WP0071			
34	 WP 2.65mm Hex Handpiece Adapter - Long	WP0074			
				Drill Extension	Catalog No.
35	 Drill Extension	RS9027			
				Hex Drivers	Catalog No.
36	 Star Hand Driver - Short	RP0064			
37	 Star Hand Driver - Long	RP0004			

*Products may be ordered separately as an addition to the kit

Advanced Kit CF6302

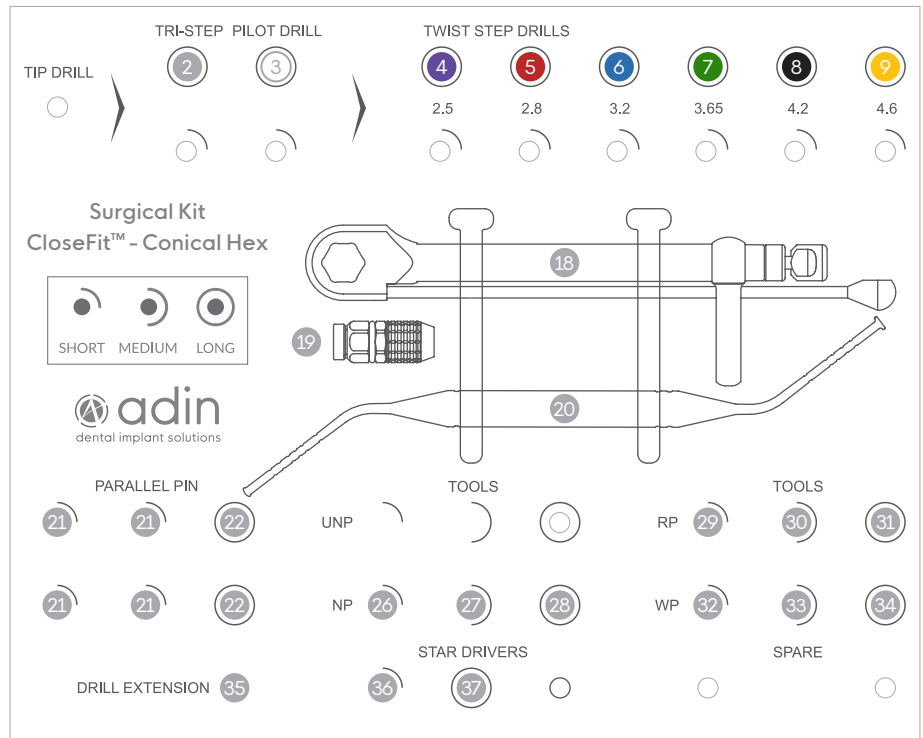

		Drills	Catalog No.
3		Pilot Drill 2mmD x 8-18mmL	DL1820
4		Twist Step Drill 2.3/2.8mmD x 8-18mmL	DL1828
5		Twist Step Drill 2.8/3.2mmD x 8-18mmL	DL1832
6		Twist Step Drill 3.2/3.6mmD x 8-18mmL	DL1836
7		Twist Step Drill 3.8/4.2mmD x 8-18mmL	DL1842
8		Twist Step Drill 4.2/4.6mmD x 8-18mmL	DL1846

		Surgical Tools	Catalog No.
18		Surgical Torque Ratchet 35-100 Ncm	RS6111
19		Wrench Ratchet Surgical Instruments Handle	RA0050
20		Depth Probe	RS6180

		Parallel Pins	Catalog No.
21		Parallel Pin Short 11mm (qty. 4)	RS6150
22		Parallel Pin Short 16mm (qty. 2)	RS6155

		Insertion Tools	Catalog No.
26		NP 2mm Hex Handpiece Adapter - Short	NP0068
27		NP 2mm Hex Handpiece Adapter - Medium	NP0071
28		NP 2mm Hex Handpiece Adapter - Long	NP0074
29		RP 2.25mm Hex Handpiece Adapter - Short	RP0068
30		RP 2.25mm Hex Handpiece Adapter - Medium	RP0071
31		RP 2.25mm Hex Handpiece Adapter - Long	RP0074
32		WP 2.65mm Hex Handpiece Adapter - Short	WP0068
33		WP 2.65mm Hex Handpiece Adapter - Medium	WP0071
34		WP 2.65mm Hex Handpiece Adapter - Long	WP0074

		Drill Extension	Catalog No.
35		Drill Extension	RS9027

		Hex Drivers	Catalog No.
36		Star Hand Driver - Short	RP0064
37		Star Hand Driver - Long	RP0004

*The advanced kit is also available with short drills | Catalog No. CF6304

Starter Kit CF6303

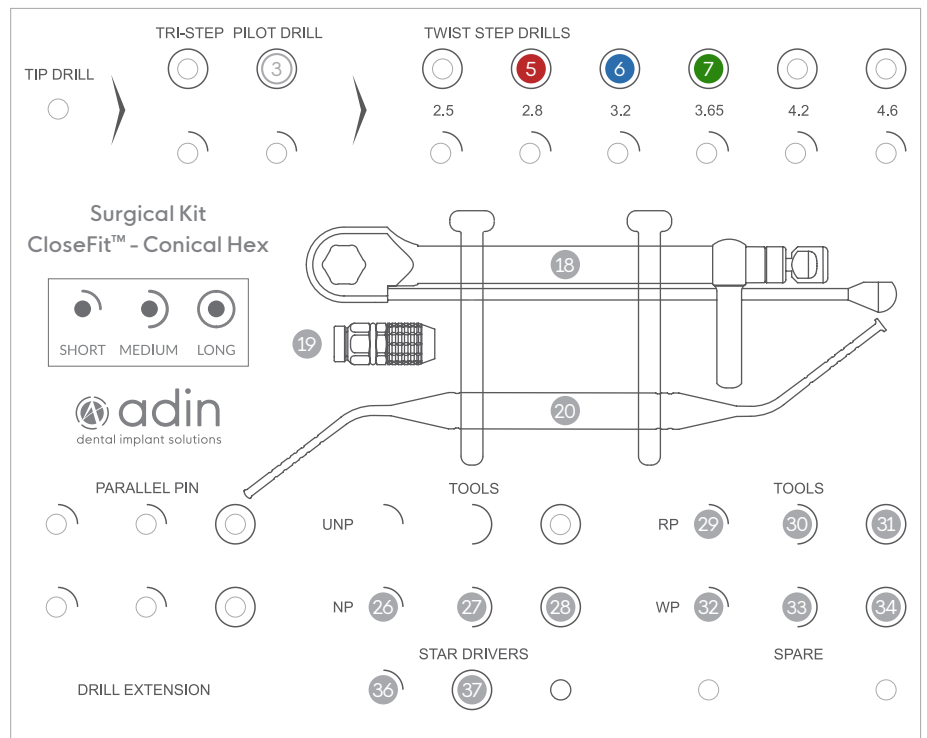

		Drills	Catalog No.
3		Pilot Drill 2mmD x 8-18mmL	DL1820
4		Twist Step Drill 2.3/2.8mmD x 8-18mmL	DL1828
5		Twist Step Drill 2.8/3.2mmD x 8-18mmL	DL1832
6		Twist Step Drill 3.2/3.6mmD x 8-18mmL	DL1836
7		Twist Step Drill 3.8/4.2mmD x 8-18mmL	DL1842

		Insertion Tools	Catalog No.
26		NP 2mm Hex Handpiece Adapter - Short	NP0068
27		NP 2mm Hex Handpiece Adapter - Medium	NP0071
28		NP 2mm Hex Handpiece Adapter - Long	NP0074
29		RP 2.25mm Hex Handpiece Adapter - Short	RP0068
30		RP 2.25mm Hex Handpiece Adapter - Medium	RP0071
31		RP 2.25mm Hex Handpiece Adapter - Long	RP0074
32		WP 2.65mm Hex Handpiece Adapter - Short	WP0068
33		WP 2.65mm Hex Handpiece Adapter - Medium	WP0071
34		WP 2.65mm Hex Handpiece Adapter - Long	WP0074

		Surgical Tools	Catalog No.
20		Wrench Ratchet	RS6100
21		Wrench Ratchet Surgical Instruments Handle	RA0050

		Hex Drivers	Catalog No.
36		Star Hand Driver - Short	RP0064
37		Star Hand Driver - Long	RP0004

Drills and Tools

Our DLC (Diamond Like Carbon) Tri-Step/Twist Step Surgical Drills are uniquely designed and coated to improve the surgical drilling process.

Tri-Step & Twist-Step DLC drills simplify the cutting process, save time and minimize risks.

Our improved DLC drill coating provides state-of-the-art hardness and slickness that increases lifespan of the drill, maintains sharpness for extended drilling and generates less heat, thereby reducing chances of heating the bone or complications arising from conventional drilling protocols.

The drills come in the following diameters (mm): 2.0, 2.5, 2.8, 3.2, 3.6, 4.2, 4.6, 5.2, 5.6

Specially designed for Adin's implants and suitable for their simple and convenient drilling protocol.

They are clearly and conveniently marked and can be used with or without drill stops.



Tri-Step Drills









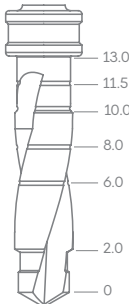

Adin's Tri-Step drills condense drilling protocols and avoid the need for using multiple drills throughout complex procedures.

Because friction at the cutting site is reduced, complications common with high speed drilling are decreased and faster & better recovery can occur.









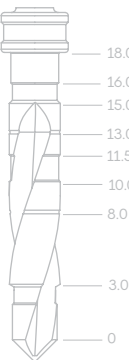

L		Ø	Size	Catalog No.
		1.8-3.2	Short	TD1511
		1.8-3.2	Long	TD2218

Twist Step Drills

Short 6-13mm





L		∅	Color	Catalog No.
		2.0	White	DL1320
		1.8-2.5	Purple	DL1325
		2.3-2.8	Red	DL1328
		2.8-3.2	Blue	DL1332
		3.2-3.6	Green	DL1336
		3.9	Pink	DL1339
		3.8-4.2	Black	DL1342
		4.2-4.6	Yellow	DL1346
		4.8-5.2	Brown	DL1352
		5.2-5.6	Grey	DL1356

Long 8-18mm













L		∅	Color	Catalog No.
		2.0	White	DL1820
		1.8-2.5	Purple	DL1825
		2.3-2.8	Red	DL1828
		2.8-3.2	Blue	DL1832
		3.2-3.6	Green	DL1836
		3.9	Pink	DL1839
		3.8-4.2	Black	DL1842
		4.2-4.6	Yellow	DL1846
		4.8-5.2	Brown	DL1852
		5.2-5.6	Grey	DL1856

Surgical Tools















	Surgical Torque Ratchet 35-100 Ncm	RS6111
	Prosthetic Torque Ratchet 15-35 Ncm	RS6112
	Wrench Ratchet	RS6100
	Surgical Driver	RS7001
	Depth Probe	RS6180



Hand & Torque Drivers Recommended Torque 25(Ncm)

	Description	Catalog No.
	Star Hand Driver 23.4mm *For Angled TMA/TMA prosthetic screw	RP0064
	Star Hand Driver 23.4mm *For Angled TMA/TMA prosthetic screw	RP0004
	TMA/FC Female Hand Hex Driver 22.4mm *For straight TMA/Flat connection	RS6193
	TMA/FC Female Hand Hex Driver 28.4mm *For straight TMA/Flat connection	RS6191
	Wrench Ratchet Surgical Instruments Handle 16.7mm	RA0050
	UNP/NP Abutment insertion tool 25.9mm	UNP1001
	NP 2mm Hex Torque Driver 17mm	NP0006
	NP 2mm Hex Torque Driver 27mm	NP0005
	Star Torque Driver 20.4mm *For Angled TMA/TMA prosthetic screw	RP0065
	Star Torque Driver 25.4mm *For Angled TMA/TMA prosthetic screw	RP0005
	Torque Driver for Ball Attachment 24.4mm	RS6090
	TMA/FC Hex Torque Driver 20mm *For straight TMA/Flat connection	RS6197
	TMA/FC Hex Torque Driver 25mm *For straight TMA/Flat connection	RS6196





Handpiece Drivers Recommended Torque 35(Ncm)

	NP 2mm Hex Handpiece Adapter 23.7mm	NP0068
	NP 2mm Hex Handpiece Adapter 27.7mm	NP0071
	NP 2mm Hex Handpiece Adapter 36mm	NP0074
	NP 2mm Hex Handpiece Adapter 20mm	NP0062
	NP 2mm Hex Handpiece Adapter 25mm	NP0072
	UNP 2mm Hex Handpiece Adapter Short 23.60L	UNP0068
	UNP 2mm Hex Handpiece Adapter Medium 27.20L	UNP0071
	UNP 2mm Hex Handpiece Adapter Long 36.00L	UNP0074
	Star Handpiece Driver 25mm *For Angled TMA/TMA prosthetic screw	RP0018
	Star Handpiece Drive 30mm *For Angled TMA/TMA prosthetic screw	RP0019
	TMA/FC Hex Handpiece Adapter 20mm *For straight TMA/Flat connection	RS6194
	TMA/FC Hex Handpiece Adapter 25mm *For straight TMA/Flat connection	RS6195A

Tools

	Description	Catalog No.
	Parallel Pin 11mm	RS6150
	Parallel Pin 16mm	RS6155
	Drill Extension	RS9027

Osteotomes

	Description	Catalog No.
	Osteotome Handle	HA0074
	Osteotome Insert 2.0mmD	HA0061
	Osteotome Insert 2.8mmD	HA0064
	Osteotome Insert 3.25mmD	HA0067
	Osteotome Insert 3.65mmD	HA0070

Guided Surgery

The adinguide™ was created with you in mind, bringing the guided surgery world to your clinic.

The kits were specifically designed to support effortless procedures, accurate and predictable implant placement.

The ActiveFlow™ Irrigation Technology is a unique design that forces coolant through the guide to ensure irrigation reaches the bone and prevents overheating.

The adinguide™ drills are designed with carved channels which allow saline coolant from your hand-piece to stream through the sleeve directly into the osteotomy site while drilling.

Our uniquely designed drill kit is intuitive and easy to use by implant diameter and length.

The Tissue Punch and Pilot Drill allow for easy flapless access.

Keyless procedure enables easy handling and full visibility of surgical field.

Self-centering drills- controlled by a 5.5mm diameter cylinder at the top of each drill centers the drill in the guide's sleeve.

Self-centering cylinder engages the sleeve before the drill engages the osteotomy in order to ensure correct positioning of the drill.

Built-in stoppers- ensure precise and accurate drilling to the desired depth.



Guided Surgery Kit

CloseFit™ UNP/NP Narrow Implants Drills & Tools

GSK002

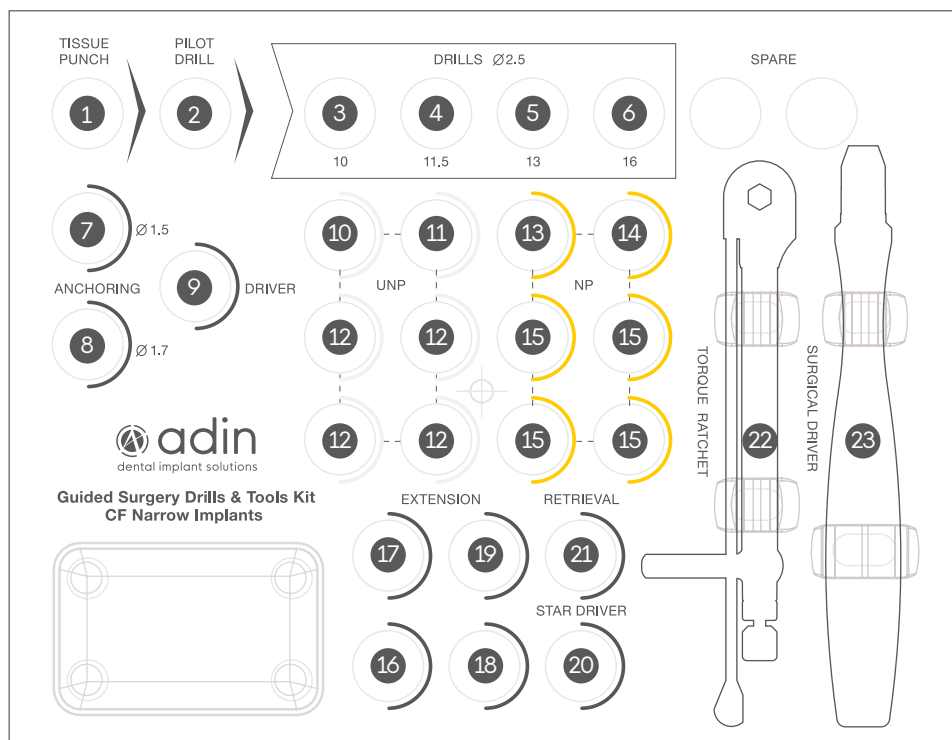













For full guided procedure:













CloseFit™ UNP/NP Narrow Implant Platform





Narrow Implants 3.3mmD Sleeve GS0033





	Description	Catalog No.
1	 Narrow Tissue Punch 3.0mmD, S-3.3	GSN3033
2	 Pilot Drill S-3.3, 2.5/1.8mmDx6.0mmL	GSN0625
3	 Drill S-3.3, 2.5/1.8mmDx10.0mmL	GSN1025
4	 Drill S-3.3, 2.5/1.8mmDx11.5mmL	GSN1125
5	 Drill S-3.3, 2.5/1.8mmDx13.0mmL	GSN1325
6	 Drill S-3.3, 2.5/1.8mmDx16.0mmL	GSN1625
7	 Anchoring Drill S-2.0, 2.0/1.5mmDx19mmL	GS1915
8	 Anchoring Drill S-2.0, 2.0/1.7mmDx19mmL	GS1917
9	 Handpiece Guide Fixation Screw Driver	GS0028
10	 Guided UNP Handpiece Fixture Mount S-3.3	GS0018
11	 Guided UNP Ratchet Fixture Mount S-3.3	GS0016
12	 Guided UNP Ratchet Fixture Mount S-3.3, Screw Retained	GS0014

	Description	Catalog No.
13	 Guided NP Handpiece Fixture Mount S-3.3	GS0017
14	 Guided NP Ratchet Fixture Mount S-3.3	GS0019
15	 Guided NP Ratchet Fixture Mount S-3.3, Screw Retained	GS0013
16	 Manual Socket L10.5	GS0023
17	 Manual Socket L14.5	GS0024
18	 Handpiece Socket L10.5	GS0021
19	 Drill extension	RS9027
20	 Star Hand Driver - Long	RP0004
21	 NP&UNP Ratchet retrieval tool	GS0045
22	 Surgical Torque Ratchet 35-100 Ncm for hex 4mm	GS6111
23	 Guide Fixation Screw Driver	GS0027



18mm Drills

	Description	Catalog No.
	Drill S-5.5, 2.5/1.8mmDx18.0mmL	GS1825
	Drill S-3.3, 2.5/1.8mmDx18.0mmL	GSN1825

	Description	Purchase Options	Catalog No.
	Guided Vertical Fixation Screw S-3.3	x3 pack	GS0006
	2.0mmD Anchoring Screw	x3 pack	GS1920
	2.0mmD Anchoring Sleeve	x3 pack	GS0020
	3.3mmD Narrow Implants Sleeve	x1 pack	GS0033
x3 pack		GS0033x3	
x10 pack		GS0033x10	

* Illustrations are not to scale

* Availability of the products in some places is limited and depends on local regulations.

* For more information, please contact your local representative.





CloseFit™

Regular and Wide Implants

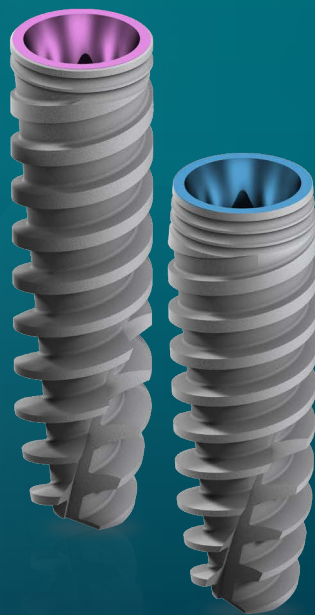

CloseFit™

Regular and Wide Implants

Our strong CloseFit™ Conical Connection is designed for optimal seating while reducing and virtually eliminating micromovements. Appropriate for immediate function/loading capability in all bone types.

CloseFit™ implants are designed to be used in all indications and in all regions of the lower and upper jaws.

The back-tapered coronal portion is designed to reduce pressure and enable healthy cortical bone around the implant collar

CloseFit™ RP

Ø 3.5mmD

Regular Platform

* Built-In Platform Switching

*

* Osseofix™

*

L-8mm | L-10 mm | L-11.5 mm

L-13 mm | L-16 mm | L-18 mm

CloseFit™ WP

Ø 4.3/5.0mmD

Wide Platform

* Back tapered collar

* Micro Threads:
Engineered to enhance bone regeneration, prevent bone loss & increase bone implant contact

* Bone - condensing property

* Self - drilling

*The features related to WP & RP Implants

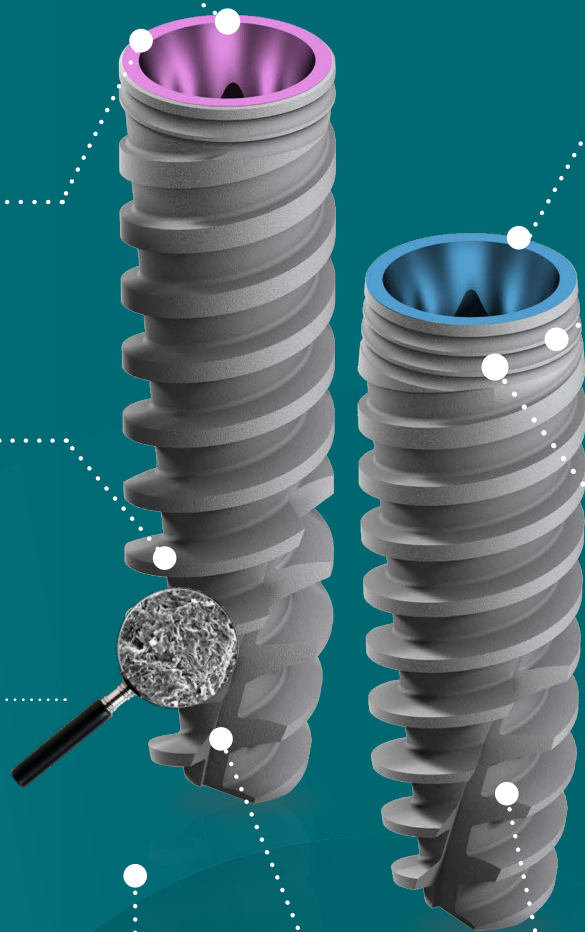

RP CloseFit™ Regular Platform

Recommended insertion torque up to 50 Ncm

	D1	L	D2	Catalog No.
	3.5	8.0	1.5	ISPX0835
		10.0	1.5	ISPX1035
		11.5	1.5	ISPX1135
		13.0	1.5	ISPX1335
		15.0	1.5	ISPX1535
		18.0	1.5	ISPX1835

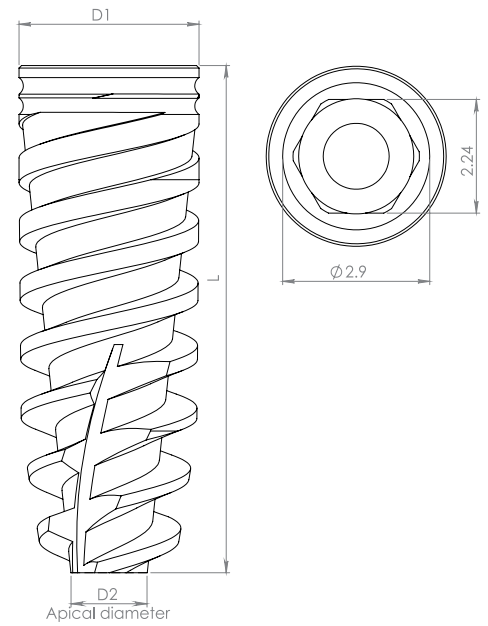

Radiographic Template RP CloseFit™ | ASD0612

Drill Sequence for RP Recommended drilling speed up to 1200 rpm

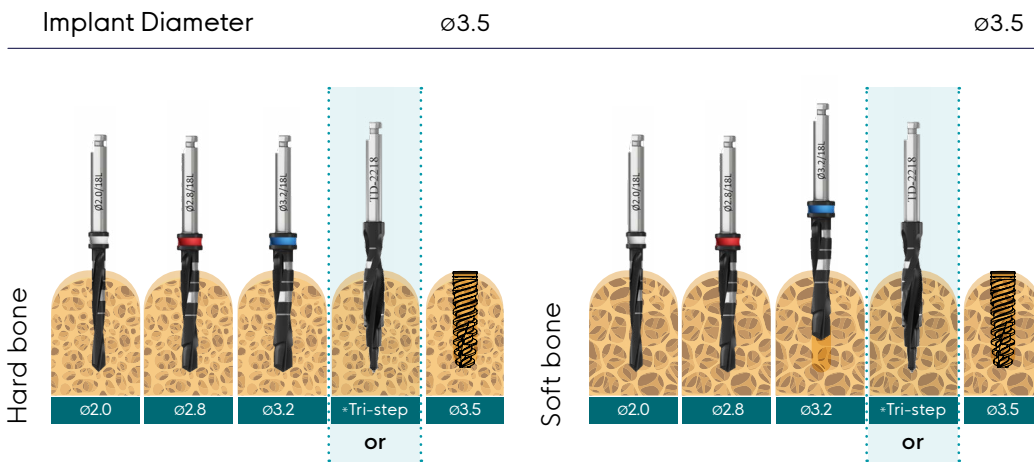

All measurements are in mm

*Products may be ordered separately as an addition to the kit.

Note: (x.xx) Drill to the depth of the cortex only. All measurements are in mm.

⚠ CAUTION: The drill preparation is up to 1mm longer than the implant.

* The drill apical step = 1.8mmD.

WP CloseFit™ Wide Platform

Recommended insertion torque up to 50 Ncm

Implant Diameter	Pitch	Implant Part Number		
		Drill Diameter	Drill Length	Implant Part Number
4.3	4.3	8.0	1.9	ISPX0843
		10.0	1.9	ISPX1043
		11.5	1.9	ISPX1143
		13.0	1.9	ISPX1343
		15.0	1.9	ISPX1543
		18.0	1.9	ISPX1843
5	5	8.0	2.5	ISPX0849
		10.0	2.5	ISPX1049
		11.5	2.5	ISPX1149
		13.0	2.5	ISPX1349
		15.0	2.5	ISPX1549
		18.0	2.5	ISPX1849

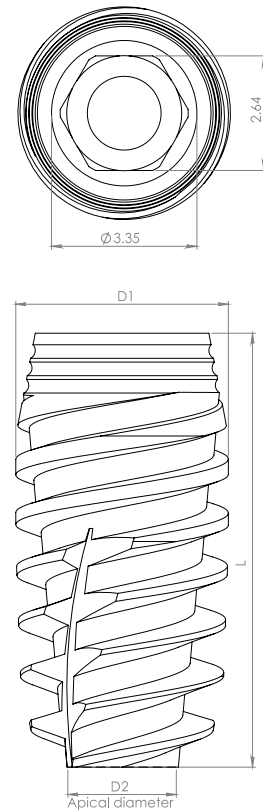

Radiographic Template WP CloseFit™ | ASD0611

Drill Sequence for RP Recommended drilling speed up to 1200 rpm

	Implant Diameter				ø4.3		ø5.0		
	ø2.0	ø2.8	ø3.2	*Tri-step	DI=1836	ø4.3	ø4.2	ø4.6	ø5.0
Hard bone									
Soft bone									

All measurements are in mm

*Products may be ordered separately as an addition to the kit.

Note: (x.xx) Drill to the depth of the cortex only. All measurements are in mm.

⚠ CAUTION: The drill preparation is up to 1mm longer than the implant.



* The drill apical step = 1.8mmD.



Cover Screw & Healing Abutments



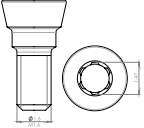

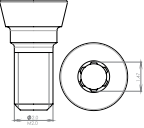

Recommended Torque 15(Ncm)



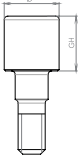

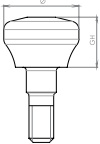

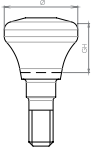

Cover Screw Packed with implant

		Description	Catalog No.
		RP CloseFit™ Conical Cover Screw	RP0073

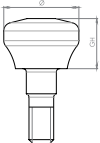
		Description	Catalog No.
		WP CloseFit™ Conical Cover Screw	WP0073

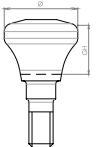
		Description	∅	GH	Catalog No.
		RP CloseFit™ Slim Healing Abutment	3.5	2	RP0046
			3.5	3	RP0047
			3.5	4	RP0048
			3.5	5	RP0049
			3.5	6	RP0050
		RP CloseFit™ Healing Abutment	4.5	2	RP0022
			4.5	3	RP0023
			4.5	4	RP0024
			4.5	5	RP0025
			4.5	6	RP0026
		RP CloseFit™ Conical Healing Abutment	4.5	2	RP0090
			4.5	3	RP0091
			4.5	4	RP0092
			4.5	5	RP0093
			4.5	6	RP0094

		Description	∅	GH	Catalog No.
		WP CloseFit™ Slim Healing Abutment	4.0	2	WP0046
			4.0	3	WP0047
			4.0	4	WP0048
			4.0	5	WP0049
			4.0	6	WP0050
		WP CloseFit™ Healing Abutment	5.5	2	WP0022
			5.5	3	WP0023
			5.5	4	WP0024
			5.5	5	WP0025
			5.5	6	WP0026
		WP CloseFit™ Conical Healing Abutment	5.5	2	WP0090
			5.5	3	WP0091
			5.5	4	WP0092
			5.5	5	WP0093
			5.5	6	WP0094

Impression Recommended Torque 15(Ncm)

Our components for taking impressions for all restoration types can be successfully utilized for digital or conventional protocols either implant-level or abutment level procedures.

Our broad range of solutions and flexible designs enable easy and accurate restorative planning, whether you're dealing with a single tooth, multiple teeth, bridge or full mouth rehabilitation.

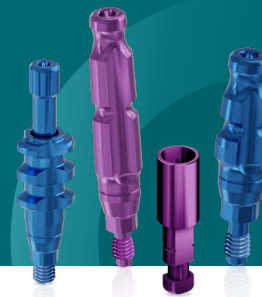

RP Transfers | Recommended Torque 15(Ncm)

	Open Tray	Description	L	D1	H	Catalog No.		Close Tray	Description	L	D1	H	Catalog No.
		RP Open Tray Transfer Short	19.5	6.0	11.8	RP5613			RP Close Tray Transfer Short	10.7	3.6	8.8	RP5111
		RP Open Tray Transfer Long	23.5	6.0	14.8	RP5617			RP Close Tray Transfer Long	14.9	3.6	13.0	RP5115

WP Transfers | Recommended Torque 15(Ncm)

	Open Tray	Description	L	D1	H	Catalog No.		Close Tray	Description	L	D1	H	Catalog No.
		WP Open Tray Transfer Short	19.5	6.0	11.8	WP5613			WP Close Tray Transfer Short	10.7	3.6	8.8	WP5111
		WP Open Tray Transfer Long	23.5	6.0	14.8	WP5617			WP Close Tray Transfer Long	15.0	3.6	13.0	WP5115

	Description	H	Catalog No.		Description	H	Catalog No.
	RP Scan Body	7	RP0088		RP Scan Body	10	RP0089

WP Scan Bodies

	Description	H	Catalog No.		Description	H	Catalog No.
	WP Scan Body	7	WP0088		WP Scan Body	10	WP0089

RP Analogs

	Description	L	D1	Catalog No.		Description	Catalog No.		Description	L	D1	Catalog No.
	RP Digital Analog 15(Ncm)	10.0	3.55	RP1000		Retaining Screw	RS1002		RP Implant Analog	12.6	3.55	RP0007

	Description	L	D1	Catalog No.		Description	Catalog No.		Description	L	D1	Catalog No.
	WP Digital Analog 15(Ncm)	10.0	4.0	WP1000		Retaining Screw	RS1002		WP Implant Analog	13.0	4.0	WP0007



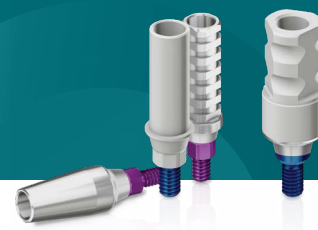

Temporary & Cement Retained Restoration

Recommended Torque 35(Ncm)

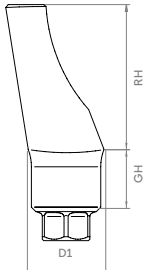

RP Abutments

		RP Engaging Temporary Abutment	3.7	1.0	9.45	RP0043		
		RP Non-Engaging Temporary Abutment	3.7	1.0	9.45	RP0044		
		RP Straight Slim Abutment No End Line	4.0	2.8	6.0	RP0020		
		RP Esthetic Straight Abutment	4.4	1.0	6.5	RP0012		
			4.4	2.0	6.5	RP0011		
			4.4	3.0	6.5	RP0010		
		RP Esthetic Angled Abutment 15°	4.4	1.0	6.5	RP0013		
			4.4	2.0	6.5	RP0014		
			4.4	3.0	6.5	RP0015		
				RP Angled Titanium Abutment 25°	4.5	1.0	6.1	RP0251
					4.5	2.0	6.1	RP0252
					4.5	3.0	6.1	RP0253
		RP Angled Titanium Abutment 35°	4.5	1.0	6.1	RP0351		
			4.5	2.0	6.1	RP0352		
			4.5	3.0	6.1	RP0353		

		Description	D1	GH	RH	Catalog No.
		RP Engaging Plastic Cylinder Abutment (Casting)	3.7	1.0	9.5	RP0045
		RP Engaging Cobalt Chrome/Plastic Abutment	4.7	1.5	10.0	RP3094
		RP Engaging Titanium/Plastic Abutment (Casting)	4.7	1.5	10.0	RP3095
		RP Non-Engaging Titanium/Plastic Abutment (Casting)	4.7	1.36	10.0	RP3097
		RP Non-Engaging Cobalt Chrome/Plastic Abutment	4.7	1.36	10.0	RP3100

WP Abutments

		Description	D1	GH	RH	Catalog No.
		WP Engaging Temporary Abutment	4.2	0.9	9.45	WP0043
		WP Non-Engaging Temporary Abutment	4.2	0.9	9.45	WP0044
		WP Straight Slim Abutment No End Line	4.2	2.7	6.0	WP0020
		WP Straight Abutment	5.0	1.0	6.5	WP0012
			5.0	2.0	6.5	WP0011
			5.0	3.0	6.5	WP0010
		WP Angled Abutment 15°	5.0	1.0	6.5	WP0013
			5.0	2.0	6.5	WP0014
			5.0	3.0	6.5	WP0015
		WP Angled Titanium Abutment 25°	5.0	1.0	6.0	WP0251
			5.0	2.0	6.0	WP0252
			5.0	3.0	6.0	WP0253
		WP Angled Titanium Abutment 35°	5.0	1.0	6.0	WP0351
			5.0	2.0	6.0	WP0352
			5.0	3.0	6.0	WP0353
	WP Plastic Cylinder Abutment (Casting)	4.2	0.9	9.45	WP0045	
	WP Engaging Titanium/Plastic Abutment (Casting)	5.2	1.5	10.0	WP3095	
	WP Non-Engaging Titanium/Plastic Abutment (Casting)	5.2	1.5	10.0	WP3097	

Iris™ Snap - on for RP and WP

Adin's Snap-on impression is an effective and easy option for both implant level and abutment level impression copying. Plastic pickup cap placed over a precision machined abutment allows for accurate coping utilizing closed tray impression. Adin's Snap-on range aims to allow flexibility by offering various options to match users preferred method of use through pre packed kits:

- IRIS™ Kit - abutment level impression and restoration set
- Snap-on impression kit - implant level impression

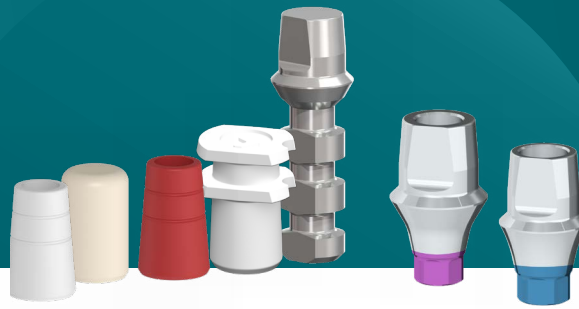

RP Iris™ Kit



Description	RH	GH	Catalog No.
Iris™ RP CloseFit™ Kit	4	1	IR3041
		2	IR3042
		3	IR3043
		4	IR3044
	6	1	IR3061
		2	IR3062
		3	IR3063
		4	IR3064
	8	1	IR3081
		2	IR3082
		3	IR3083
		4	IR3084



Description	RH	GH	Catalog No.
Iris™ RP Snap-on Impression Kit	4	1	IR3141
		2	IR3142
		3	IR3143
		4	IR3144
	6	2	IR3262
		4	IR3264

RP Snap-on Impression Pack



Description	RH	GH	Catalog No.
Iris™ RP Abutment	4	1	IR0341
		2	IR0342
		3	IR0343
		4	IR0344
	6	1	IR0361
		2	IR0362
		3	IR0363
		4	IR0364
	8	1	IR0381
		2	IR0382
		3	IR0383
		4	IR0384

WP Iris™ Kit



Iris™ WP CloseFit™ Kit	4	1	IR5041
		2	IR5042
		3	IR5043
		4	IR5044
	6	1	IR5061
		2	IR5062
		3	IR5063
		4	IR5064

WP Snap-on Impression Kit







Description	RH	GH	Catalog No.
Iris™ WP Snap-on Impression Kit	4	1	IR5141
		2	IR5142
		3	IR5143
		4	IR5144
	6	2	IR5262
		4	IR5264



WP Snap-on Impression Pack



Description	RH	GH	Catalog No.
Iris™ WP Abutment	4	1	IR0541
		2	IR0542
		3	IR0543
		4	IR0544
	6	1	IR0561
		2	IR0562
		3	IR0563
		4	IR0564







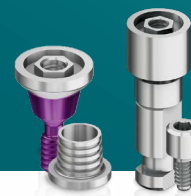





Purchase Options

	Description	RH	Catalog No.
	RP Implant Analog	-	RP0007
	WP Implant Analog	-	WP0007
	Iris™ Abutment replica	4	IR0404
		6	IR0406
		8	IR0408
	Iris™ PEEK Comfort cap	4	IR0180
		6	IR0181
		8	IR0189













	Description	Qty	Catalog No.
	Iris™, Burnout anti rotation cap red	1	IR0182
		4	IR0185
	Iris™, Burnout cap white	4	IR0183
		6	IR0186
	Iris™, Impression coping	1	IR0179
		4	IR0184



RP Screws

	Description	L	∅	Catalog No.
	RP Abutment Screw	7.2	2.2	RP0001
	TMA Prosthetic Screw 15(Ncm)	4.1	2.1	RS3404
	RP Retaining Screw for TMA 1mm	8.0	3.1	RP0039
	RP Retaining Screw for TMA 2mm	9.0	3.1	RP0040
	RP Retaining Screw for TMA 3mm	10.0	3.1	RP0041
	RP Retaining Screw for TMA 4mm	11.0	3.1	RP3409
	RP Retaining Screw for TMA 5mm	12.0	3.1	RP3412
	RP Retaining Screw for Angled TMA	7.0	2.35	RP3403
	RP Open Tray Transfer Screw - Short	24.0	3.1	RP5010
	RP Open Tray Transfer Screw - Long	28.0	3.1	RP5014
	RP Closed Tray Transfer Screw - Short	16.0	2.8	RP5126
	RP Closed Tray Transfer Screw - Long	20.0	2.8	RP5127
	RP Retrieval Screw for Abutments	12.6	2.25	RP3401

WP Screws





	Description	L	Ø	Catalog No.
	WP Abutment Screw	7.5	2.55	WP0001
	TMA Prosthetic Screw 15(Ncm)	4.1	2.1	RS3404
	WP Retaining Screw for TMA	6.5	3.1	WP3406
	WP Retaining Screw for TMA	7.5	3.1	WP3407
	WP Retaining Screw for TMA	8.5	3.1	WP3408
	WP Retaining Screw for TMA	9.5	3.1	WP3409
	WP Retaining Screw for TMA	10.5	3.1	WP3412
	WP Retaining Screw for Angled TMA	7.1	2.35	WP3403
	WP Open Tray Transfer Screw - Short	24.0	3.1	WP5010
	WP Open Tray Transfer Screw - LONG	28.0	3.1	WP5014
	WP Closed Tray Transfer Screw - Short	16.5	3.1	WP5126
	WP Closed Tray Transfer Screw - Long	20.0	3.1	WP5127
	WP Retrieval Screw for Abutments	12.3	2.55	WP3401

Single TMA™ Recommended Torque 35(Ncm)



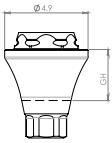

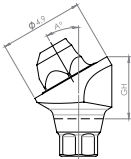
Adding to Adin's variety of the screw-retained restoration range, in comes the single TMA. Utilizing all the benefits of the TMA abutments while allowing the accuracy and flexibility for single tooth restoration.

Adin's STMA offers the possibility to combine the benefits of trans-gingival approach and screw-retained single tooth restoration yielding greater flexibility in both esthetics, safety and restoration maintenance. Adin's Single TMA is based on the TMA abutment, while the added hex index offers both the required accurate positioning and retention to support a single tooth crown. Open and closed tray transfers as well as scan bodies for digital impression are available to match every preferred impression method as well as replicas for straight forward and simple work process.

RP Abutments

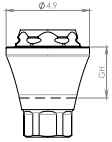
		Description	GH	Catalog No.
		RP Straight Single TMA Abutment 1mm	1.0	RP0032S
		RP Straight Single TMA Abutment 2mm	2.0	RP0033S
		RP Straight Single TMA Abutment 3mm	3.0	RP0034S
		RP Straight Single TMA Abutment 4mm	4.0	RP3729S
		RP Straight Single TMA Abutment 5mm	5.0	RP3730S
		RP Angled Single TMA Abutment 17° 2.5mm	2.6	RP3734S
		RP Angled Single TMA Abutment 30° 3mm	3.7	RP3735S
		RP Angled Single TMA Abutment 17° 3.5mm	3.5	RP3737S
		RP Angled Single TMA Abutment 30° 4mm	4.0	RP3738S

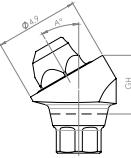

WP Abutments

		Description	GH	Catalog No.
		WP Straight Single TMA Abutment 1mm	1.0	WP3731S
		WP Straight Single TMA Abutment 2mm	2.0	WP3732S
		WP Straight Single TMA Abutment 3mm	3.0	WP3733S
		WP Straight Single TMA Abutment 4mm	4.0	WP3729S
		WP Straight Single TMA Abutment 5mm	5.0	WP3730S
		WP Angled Single TMA Abutment 17° 2.5mm	2.5	WP3734S
		WP Angled Single TMA Abutment 30° 3mm	3.5	WP3735S
		WP Angled Single TMA Abutment 17° 3.5mm	3.5	WP3737S
		WP Angled Single TMA Abutment 30° 4mm	4.1	WP3738S

Transfers

	Description	L	D1	D2	Catalog No.		Description	L	D1	D2	Catalog No.
	Single TMA Impression Coping Open Tray	11.0	4.9	3.1	RS5006S		Single TMA Closed Tray Transfer	8.0	4.9	4.1	RS5011S

Snap-On

	Description	L	D1	D2	Catalog No.		Description	L	D1	D2	Catalog No.
	Single TMA Snap-On Transfer	8.0	4.9	3.2	RS5012S		IRIS™, Impression coping				IR0179





Analogs

	Description	L	D1	Catalog No.		Description	L	D1	D2	Catalog No.
	Single TMA Abutment Replica	16.8	3.35	RS5004S		Single TMA Digital Model Replica Recommended torque 15(Ncm)	12.0	4.9	3.8	RS1001S

Scan Bodies

	Description	L	D1	Catalog No.
	Single TMA Scan Body	6.0	4.9	TM0006S
		9.0	4.9	TM0009S

STMA Prosthetics

	Description	L	D1	D2	H	Catalog No.
	Single TMA Titanium Temporary	12.0	4.9	3.5	10.5	RS4900S
	Single TMA Plastic Casting Sleeve w/Prosthetic Screw	12.0	4.9	3.3	10.5	RS5001S
	Single TMA Healing Cup	5.5	4.9	3.5	-	RS5005S
	Single TMA Cementing Cone, low profile	4.9	5.5	3.2	-	TM0011S





CAD CAM

Adin's CAD - CAM components and digital libraries enable clinicians and technicians to design and manufacture state-of-the-art restorations supported by Adin's implants, using current digital restoration processes.



The variety of components ensures endless restorative options for treatment of single, multiple, partially, or fully edentulous cases.







RP

For Intra-oral and Desktop Scanner		H	Catalog No.	For Medentika PreFace® Holder		Ø	Catalog No.
	RP Scan Body	7	RP0088		RP Ti Blank	11.5	RP1211
		10	RP0089			15.8	RP1215



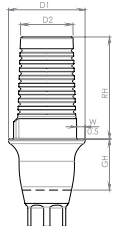

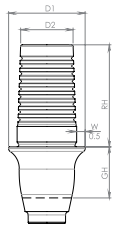
WP

For Intra-oral and Desktop Scanner		H	Catalog No.	For Medentika PreFace® Holder		Ø	Catalog No.
	WP Scan Body	7	WP0088		WP Ti Blank	11.5	WP1311
		10	WP0089			15.8	WP1315



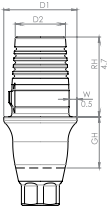

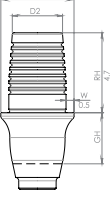
RP Ti Base Abutments

Description		RH	GH	D1	D2	Catalog No.
	 Ti Base RP Abutment, Engaged	4.0	1.0	4.5	3.2	TB03411
		4.0	2.0	4.5	3.2	TB03421
		4.0	3.0	4.5	3.2	TB03431
		4.0	4.0	4.5	3.2	TB03441
		6.0	1.0	4.5	3.1	TB03611
		6.0	2.0	4.5	3.1	TB03621
		6.0	3.0	4.5	3.1	TB03631
		6.0	4.0	4.5	3.1	TB03641
		8.0	1.0	4.5	2.9	TB03811
		8.0	2.0	4.5	2.9	TB03821
		8.0	3.0	4.5	2.9	TB03831
		8.0	4.0	4.5	2.9	TB03841
	 Ti Base RP Abutment, Non Engaged	4.0	1.0	4.5	3.2	TB03412
		4.0	2.0	4.5	3.2	TB03422
		4.0	3.0	4.5	3.2	TB03432
		4.0	4.0	4.5	3.2	TB03442
		6.0	1.0	4.5	3.1	TB03612
		6.0	2.0	4.5	3.1	TB03622
		6.0	3.0	4.5	3.1	TB03632
		6.0	4.0	4.5	3.1	TB03642
		8.0	1.0	4.5	2.9	TB03812
		8.0	2.0	4.5	2.9	TB03822
		8.0	3.0	4.5	2.9	TB03832
		8.0	4.0	4.5	2.9	TB03842

For further product information and use please refer to IFU028

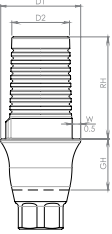
	Description	RH	GH	D1	D2	Catalog No.
	 C-Type Ti Base RP Abutment, Engaged	4.7	1.0	4.3	2.9	TB03414
		4.7	2.0	4.3	2.9	TB03424
		4.7	3.0	4.3	2.9	TB03434
		4.7	4.0	4.3	2.9	TB03444
	 C-Type Ti Base RP Abutment, Non Engaged	4.7	1.0	4.3	2.9	TB03415
		4.7	2.0	4.3	2.9	TB03425
		4.7	3.0	4.3	2.9	TB03435
		4.7	4.0	4.3	2.9	TB03445

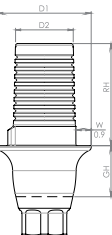

WP Ti Base Abutments

	Description	RH	GH	D1	D2	Catalog No.
	 Ti Base WP Abutment, Engaged	4.0	1.0	4.7	3.5	TB05411
		4.0	2.0	4.7	3.5	TB05421
		4.0	3.0	4.7	3.5	TB05431
		4.0	4.0	4.7	3.5	TB05441
		6.0	1.0	4.7	3.4	TB05611
		6.0	2.0	4.7	3.4	TB05621
		6.0	3.0	4.7	3.4	TB05631
		6.0	4.0	4.7	3.4	TB05641
		8.0	1.0	4.7	3.3	TB05811
		8.0	2.0	4.7	3.3	TB05821
		8.0	3.0	4.7	3.3	TB05831
		8.0	4.0	4.7	3.3	TB05841
	 Ti Base WP Abutment, Engaged Wide	4.0	1.0	5.5	3.5	TB05411W
		4.0	2.0	5.5	3.5	TB05421W
		4.0	3.0	5.5	3.5	TB05431W
		4.0	4.0	5.5	3.5	TB05441W
		6.0	1.0	5.5	3.4	TB05611W
		6.0	2.0	5.5	3.4	TB05621W
		6.0	3.0	5.5	3.4	TB05631W
		6.0	4.0	5.5	3.4	TB05641W
		8.0	1.0	5.5	3.3	TB05811W
		8.0	2.0	5.5	3.3	TB05821W
		8.0	3.0	5.5	3.3	TB05831W
		8.0	4.0	5.5	3.3	TB05841W

	Description	RH	GH	D1	D2	Catalog No.
	<p>Ti Base WP Abutment, Non Engaged</p>	4.0	1.0	4.7	3.5	TB05412
		4.0	2.0	4.7	3.5	TB05422
		4.0	3.0	4.7	3.5	TB05432
		4.0		4.7	3.5	TB05442
		6.0	1.0	4.7	3.4	TB05612
		6.0	2.0	4.7	3.4	TB05622
		6.0	3.0	4.7	3.4	TB05632
		6.0	4.0	4.7	3.4	TB05642
		8.0	1.0	4.7	3.3	TB05812
		8.0	2.0	4.7	3.3	TB05822
		8.0	3.0	4.7	3.3	TB05832
		8.0	4.0	4.7	3.3	TB05842
	<p>Ti Base WP Abutment, Non Engaged Wide</p>	4.0	1.0	5.5	3.5	TB05412W
		4.0	2.0	5.5	3.5	TB05422W
		4.0	3.0	5.5	3.5	TB05432W
		4.0	4.0	5.5	3.5	TB05442W
		6.0	1.0	5.5	3.4	TB05612W
		6.0	2.0	5.5	3.4	TB05622W
		6.0	3.0	5.5	3.4	TB05632W
		6.0	4.0	5.5	3.4	TB05642W
		8.0	1.0	5.5	3.3	TB05812W
		8.0	2.0	5.5	3.3	TB05822W
		8.0	3.0	5.5	3.3	TB05832W
		8.0	4.0	5.5	3.3	TB05842W

For further product information and use please refer to IFU028

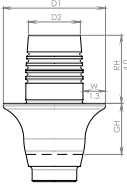
	Description	RH	GH	D1	D2	Catalog No.
	<p>C-Type Ti Base WP Abutment, Engaged</p>	4.0	1.0	4.8	3.0	TB05414
		4.0	2.0	4.8	3.0	TB05424
		4.0	3.0	4.8	3.0	TB05434
		4.0	4.0	4.8	3.0	TB05444
	<p>C-Type Ti Base WP Abutment, Engaged Wide</p>	4.0	1.0	6.0	3.0	TB05414W
		4.0	2.0	6.0	3.0	TB05424W
		4.0	3.0	6.0	3.0	TB05434W
		4.0	4.0	6.0	3.0	TB05444W
	<p>C-Type Ti Base WP Abutment, Non Engaged</p>	4.0	1.0	4.8	3.1	TB05415
		4.0	2.0	4.8	3.1	TB05425
		4.0	3.0	4.8	3.1	TB05435
		4.0	4.0	4.8	3.1	TB05445

	Description	RH	GH	D1	D2	Catalog No.
	 C-Type Ti Base WP Abutment, Non Engaged Wide	4.0	1.0	6.0	3.1	TB05415W
		4.0	2.0	6.0	3.1	TB05425W
		4.0	3.0	6.0	3.1	TB05435W
		4.0	4.0	6.0	3.1	TB05445W

CAD CAM | Angulated Screw Channel

The angulated screw channel (ASC) solution offers a transformative approach to dental restorations. ASC strategically places a screw access hole at an angle within the prosthesis, optimizing both function and esthetics.

By integrating digital planning and specialized drivers, ASC enhances accuracy and predictability in implant-supported restorations. This approach signifies a significant advancement in dental care, prioritizing esthetics and functionality to ensure patient satisfaction.

Adin's angulated screw channel Ti bases support gingival heights of 1-3mm for every each implant platform and allow for angulation of up to 20 degrees.

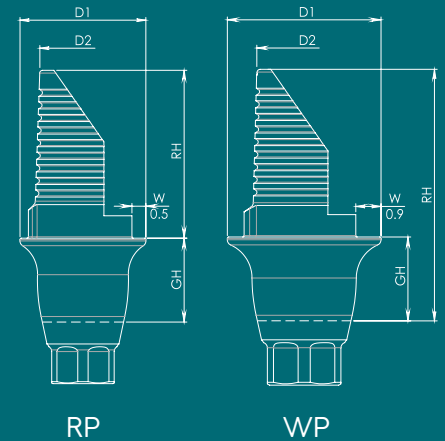



RP Ti Base Abutment Angular

	RH	GH	D1	D2	Catalog No.
 RP Ti Base Abutment Angular Engaged	4.0	1.0	4.5	3.2	TB03413
	4.0	2.0	4.5	3.2	TB03423
	4.0	3.0	4.5	3.2	TB03433
	6.0	1.0	4.5	3.1	TB03613
	6.0	2.0	4.5	3.1	TB03623
	6.0	3.0	4.5	3.1	TB03633
	8.0	1.0	4.5	2.9	TB03813
	8.0	2.0	4.5	2.9	TB03823
	8.0	3.0	4.5	2.9	TB03833

	Abutments are supplied with RP0001 screw. Recommended torque 25Ncm. Also available separately	RP0001
---	---	--------

WP Ti Base Abutment Angular

	RH	GH	D1	D2	Catalog No.
 WP Ti Base Abutment Angular Engaged	4.0	1.0	4.7	3.5	TB05413
	4.0	2.0	4.7	3.5	TB05423
	4.0	3.0	4.7	3.5	TB05433
	6.0	1.0	4.7	3.4	TB05613
	6.0	2.0	4.7	3.4	TB05623
	6.0	3.0	4.7	3.4	TB05633
	8.0	1.0	4.7	3.3	TB05813
	8.0	2.0	4.7	3.3	TB05823
	8.0	3.0	4.7	3.3	TB05833

 WP Ti Base Abutment Angular Engaged Wide	4.0	1.0	5.5	3.5	TB05413W
	4.0	2.0	5.5	3.5	TB05423W
	4.0	3.0	5.5	3.5	TB05433W
	6.0	1.0	5.5	3.4	TB05613W
	6.0	2.0	5.5	3.4	TB05623W
	6.0	3.0	5.5	3.4	TB05633W
	8.0	1.0	5.5	3.3	TB05813W
	8.0	2.0	5.5	3.3	TB05823W
	8.0	3.0	5.5	3.3	TB05833W

	Abutments are supplied with WP0001 screw. Recommended torque 25Ncm. Also available separately	WP0001
---	---	--------



Angulated Tools

	Description	L	L2	D1	D2	Catalog No.
	Angulated Screw Extractor Hand Driver	24.7	10	1.4	9.4	RP6400
	Angulated Star Screw Hand Driver - Short 23.4L	23.4	9.0	1.4	9.4	RP6401
	Angulated Star Screw Hand Driver - Long 28.4L	28.4	14.0	1.4	9.4	RP6402
	Angulated Star Screw Torque Driver - Short 17.0L	17.0	11.0	1.4	7.0	RP6403
	Angulated Star Screw Torque Driver - Long 22.0L	22.0	16.0	1.4	7.0	RP6404
	Angulated Star Screw Handpiece Driver - Extra Short 20.0L	20.0	7.0	1.4	2.35	RP6405
	Angulated Star Screw Handpiece Driver - Short 25.0L	25.0	12.0	1.4	2.35	RP6406
	Angulated Star Screw Handpiece Driver - Long 30.0L	30.0	17.0	1.4	2.35	RP6407



Digital Analogs

	Description	L	D1	Catalog No.		Description	Catalog No.		Description	L	D1	Catalog No.
	RP CloseFit™ Digital Analog	10.0	3.55	RP1000		Retaining Screw	RS1002		WP CloseFit™ Digital Analog	10.0	4.0	WP1000



Screws

	Description	Catalog No.
	RP CloseFit™ Abutment Screw	RP0001
	WP CloseFit™ Abutment Screw	WP0001





TMA - Multi Unit Screws

	Description	Catalog No.
	TMA Scan Body Screw	TM0001
	TMA Prosthetic Screw	RS3404

| For Intra-oral and Desktop Scanner

	Description	L	D1	Catalog No.		Description	L	D1	Catalog No.
	Single TMA Scan Body	6.0	4.9	TM0006S		TMA Scan Body	6.0	4.9	TM0006
		9.0	4.9	TM0009S			9.0	4.9	TM0009

STMA / TMA Cementing Cone & Temporary Cylinder

	Description	L	D1	D2	H	Catalog No.						
	Single TMA Titanium Temporary	12.0	4.9	3.5	10.5	RS4900S		Single TMA Cementing Cone, low profile	4.9	5.5	3.2	TM0011S
								TMA Cementing Cone, low profile	4.9	5.5	3.2	TM0011
	TMA Titanium Temporary	12.0	4.9	3.5	10.5	RS4900		TMA Cementing Cone	4.9	4.9	3.8	TM0010

Tool Drivers

	Description	L	Catalog No.		Description	L	Catalog No.
	Star Hand Driver Short	23.4	RP0064		Star Hand Driver Long	28.4	RP0004

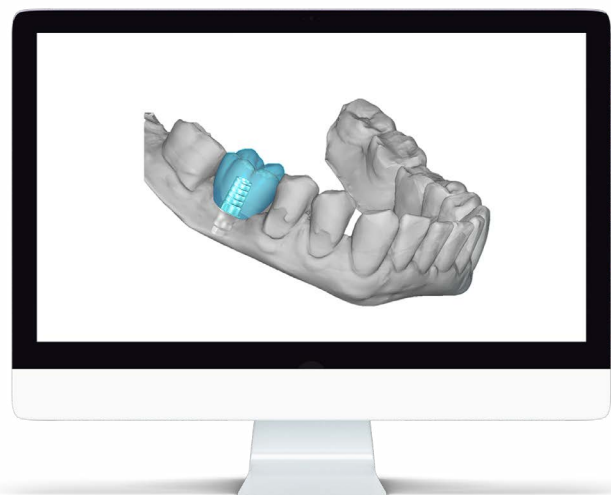

TMA™ - Multi Unit Recommended Torque 35(Ncm)

Our TMA™ (Trans Mucosal Abutment) system is indicated for multiple-unit, screw-retained restorations, and may be used in combination with an implant-level framework design.

- Elevates restorative seating platform when implant-level restoration is not practical
- Provides better access when using implants with divergent angles
- Accommodates full and partial edentulous arches
- Available in straight or angled (17°, 30°, 45°) with different gingival heights
- Abutments are delivered with handles for easy insertion and seating

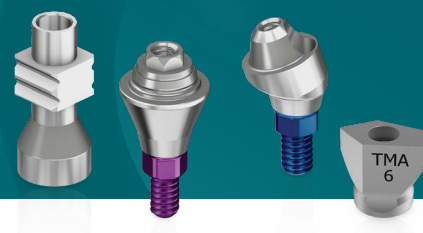



RP TMA

		Description	GH	Catalog No.
		RP Straight Trans Mucosal Abutment	1.0	RP0032
			2.0	RP0033
			3.0	RP0034
			4.0	RP3729
			5.0	RP3730
		RP Angled Trans Mucosal Abutment 17° 2.5mm	2.58	RP3734
		RP Angled Trans Mucosal Abutment 17° 3.5mm	3.66	RP3735
		RP Angled Trans Mucosal Abutment 30° 3mm	3.68	RP3737
		RP Angled Trans Mucosal Abutment 30° 4mm	4.0	RP3738

WP TMA

		Description	GH	Catalog No.
		WP Straight Trans Mucosal Abutment	1.0	WP3731
			2.0	WP3732
			3.0	WP3733
			4.0	WP3729
			5.0	WP3730
		WP Angled Trans Mucosal Abutment 17° 2.5mm	2.5	WP3734
		WP Angled Trans Mucosal Abutment 17° 3.5mm	3.5	WP3737
		WP Angled Trans Mucosal Abutment 30° 3mm	3.5	WP3735
		WP Angled Trans Mucosal Abutment 30° 4mm	4.1	WP3738
		WP Angled Trans Mucosal Abutment 45° 4mm	4.4	WP3736
		WP Angled Trans Mucosal Abutment 52° 5mm	4.8	WP3739
		WP Angled Trans Mucosal Abutment 60° 5mm	5.5	WP3740

Transfers

	Description	L	D1	D2	Catalog No.
	TMA Impression Coping Open Tray	11.0	4.9	3.1	RS5006
	TMA Closed Tray Transfer	8.0	4.9	4.1	RS5011
	TMA Healing Cup	5.5	4.9	3.5	RS5005

Analogs

	Description	L	D1	D2	Catalog No.
	TMA Abutment Replica	16.8	3.35	-	RS5004
	TMA Digital Model Replica Recommended torque 15(Ncm)	12.0	4.9	3.8	RS1001

	Description	L	D1	Catalog No.
	TMA Scan Body	6.0	4.9	TM0006
		9.0	4.9	TM0009



TMA Screw For Scan Body & Cementing Cone

	Description	Catalog No.
	TMA Scan Body Screw	TM0001



TMA Screw Temporary Cylinder & STMA Direct Option

	Description	Catalog No.
	TMA Prosthetic Screw	RS3404

Snap-On

	Description	L	D1	D2	Catalog No.		Description	Catalog No.
	TMA Snap-On Transfer	8.0	4.9	3.2	RS5012		IRIS™, Impression coping	IR0179

TMA Prosthetics

	Description	L	D1	D2	H	Catalog No.		Description	L	D1	D2	Catalog No.
	TMA Titanium Temporary	12.0	4.9	3.5	10.5	RS4900		TMA Cementing Cone, low profile	4.9	5.5	3.2	TM0011
	TMA Plastic Casting Sleeve /Prosthetic Screw	12.0	4.9	3.3	10.5	RS5001		TMA Cementing Cone	4.9	5.5	2.9	TM0010

Overdenture Restoration

Recommended Torque 25(Ncm)



		Description	GH	RH	H	Catalog No.
		RP Ball Attachment	0.5	2.7	4.0	RP0051
			1.0	2.7	4.5	RP0052
			2.0	2.7	5.5	RP0053
			3.0	2.7	6.5	RP0054
			4.0	2.7	7.5	RP0055
			5.0	2.7	8.5	RP0056
		WP Ball Attachment	0.5	2.7	4.0	WP0051
			1.0	2.7	4.5	WP0052
			2.0	2.7	5.5	WP0053
			3.0	2.7	6.5	WP0054
			4.0	2.7	7.5	WP0055
			5.0	2.7	8.5	WP0056

	Description	L	Ø	Catalog No.
	Ball Attachment Replica	16.6	4.0	RS5740

	Description	L	Ø	D2	Catalog No.
	Plastic Ball Cap White (Nylon)	2.6	4.1	3.6	RS2660
	Plastic Ball Cap Pink Soft (Nylon)	2.6	4.1	3.6	RS2662
	Titanium Ball Cap	2.9	4.7	4.7	RS2670
	Stainless Steel Ball Cap	2.90	4.70	4.70	RS2675SS

Grip™ - Overdenture Attachment

As an addition to our wide variety of prosthetic solutions.

Implant supported overdentures are among the most practical prosthetic solutions for patients who cannot utilize fixed restorations, or as an interim solution for patients who are waiting for the osseointegration process of their newly placed implants.

The Grip™ attachment system is a versatile solution, designed to ensure maximum denture retention and stability both for maxillary and mandibular dentures. The variety of retentive caps allow dentists to choose the required retention level needed for each individual case and can easily be replaced, when needed.

The Grip™ attachment system is available for Internal Hex in a range of gingival heights, to enable a reliable, long lasting and cost-effective solution for your patients.

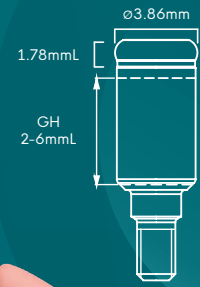

RP Grip™ Abutments







	Description	Catalog No.
	Grip RP Abutment 1mm	RP0038
	Grip RP Abutment 2mm	RP0057
	Grip RP Abutment 3mm	RP0058
	Grip RP Abutment 4mm	RP0059
	Grip RP Abutment 5mm	RP0060
	Grip RP Abutment 6mm	RP0061

WP Grip™ Abutments

	Description	Catalog No.
	Grip WP Abutment 1mm	WP0063
	Grip WP Abutment 2mm	WP0057
	Grip WP Abutment 3mm	WP0058
	Grip WP Abutment 4mm	WP0059
	Grip WP Abutment 5mm	WP0060
	Grip WP Abutment 6mm	WP0061

Included in Sales Pack

Grip™ Processing Set







	Description		Description	Catalog No.
	Housing		Light	RS6426
	Processing		Regular	
	Extra Light		Block Out Spacer	



	Description	Catalog No.
	Grip™ for TMA	TM0100
	Grip™ for Bar, M2 thread	RS0101





Or



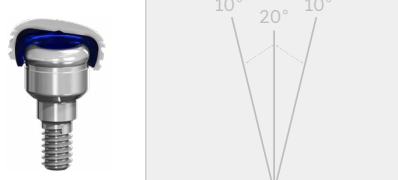

Grip™ Extended Range processing set

	Description		Description	Catalog No.
	Housing		Light	RS6427
	Processing		Regular	
	Zero		Block Out Spacer	
	Extra Light			



Grip™ Retention Caps

Grip Retention 4 Pack		Description	Catalog No.
		Extra Light	RS6417
		Light	RS6418
		Regular	RS6419

Grip™ Extended Range Retention 4 Pack		Description	Catalog No.
		Zero	RS6420
		Extra Light	RS6421
		Light	RS6422
		Regular	RS6423



Grip™ Accessories

	Description	Catalog No.	Description	Catalog No.
	Grip™ Impression Coping 4 Pack Includes RS6415 Grip™ Processing 4 Pack	RS6414		Grip™ Replica 4 Pack RS2508
	Metal Housing 4 Pack Includes RS6415 Grip™ Processing 4 Pack	RS6413		
	Grip™ Block Out Spacer 4 Pack	RS6424		Grip™ Processing 4 Pack RS6415
				Grip™ Processing 20 Pack RS6416

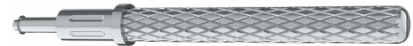
Grip™ Tools

	Description	Catalog No.
	Grip™ core tool	RS6200

Designed for inserting and removing the Grip™ retention males from the metal housing

Description	Catalog No.	Description	Catalog No.	Description	Catalog No.
	Star Hand Driver Short RP0064		1.27 Hex torque driver-long RS6082		1.27 Hex driver for handpiece - long RS9035
	Star Hand Driver Long RP0004		1.27 Hex torque driver-short RS6080		1.27 Hex driver for handpiece - short RS9030

Surgical Kits

Successful surgical procedures start with having the right instruments and tools to ensure your desired treatment outcomes are met.

That's why our range has everything you need, including drills, keys, ratchets and insertion tools.

Not only do they make procedures safer and simpler, they result in an enhanced patient experience as well.

Our Surgical Kits streamline and simplify your implant procedures.



Advanced Kit CF6302

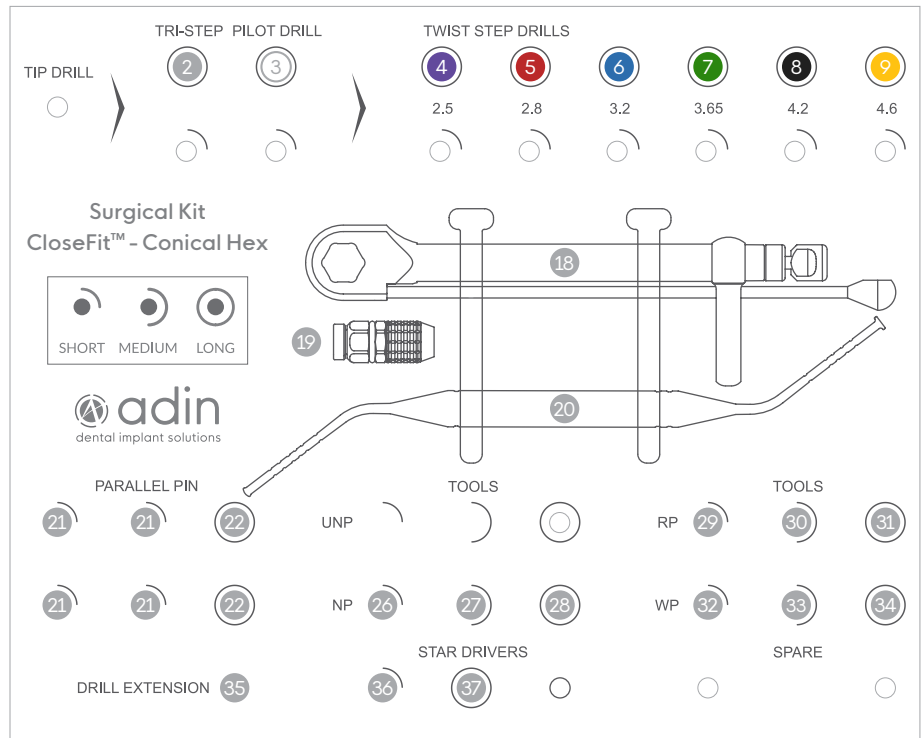

		Drills	Catalog No.
3		Pilot Drill 2mmD x 8-18mmL	DL1820
4		Twist Step Drill 2.3/2.8mmD x 8-18mmL	DL1828
5		Twist Step Drill 2.8/3.2mmD x 8-18mmL	DL1832
6		Twist Step Drill 3.2/3.6mmD x 8-18mmL	DL1836
7		Twist Step Drill 3.8/4.2mmD x 8-18mmL	DL1842
8		Twist Step Drill 4.2/4.6mmD x 8-18mmL	DL1846

		Surgical Tools	Catalog No.
18		Surgical Torque Ratchet 35-100 Ncm	RS6111
19		Wrench Ratchet Surgical Instruments Handle	RA0050
20		Depth Probe	RS6180

		Parallel Pins	Catalog No.
21		Parallel Pin Short 11mm (qty. 4)	RS6150
22		Parallel Pin Short 16mm (qty. 2)	RS6155

		Insertion Tools	Catalog No.
26		NP 2mm Hex Handpiece Adapter - Short	NP0068
27		NP 2mm Hex Handpiece Adapter - Medium	NP0071
28		NP 2mm Hex Handpiece Adapter - Long	NP0074
29		RP 2.25mm Hex Handpiece Adapter - Short	RP0068
30		RP 2.25mm Hex Handpiece Adapter - Medium	RP0071
31		RP 2.25mm Hex Handpiece Adapter - Long	RP0074
32		WP 2.65mm Hex Handpiece Adapter - Short	WP0068
33		WP 2.65mm Hex Handpiece Adapter - Medium	WP0071
34		WP 2.65mm Hex Handpiece Adapter - Long	WP0074

		Drill Extension	Catalog No.
35		Drill Extension	RS9027

		Hex Drivers	Catalog No.
36		Star Hand Driver - Short	RP0064
37		Star Hand Driver - Long	RP0004

*The advanced kit is also available with short drills | Catalog No. CF6304

Starter Kit CF6303

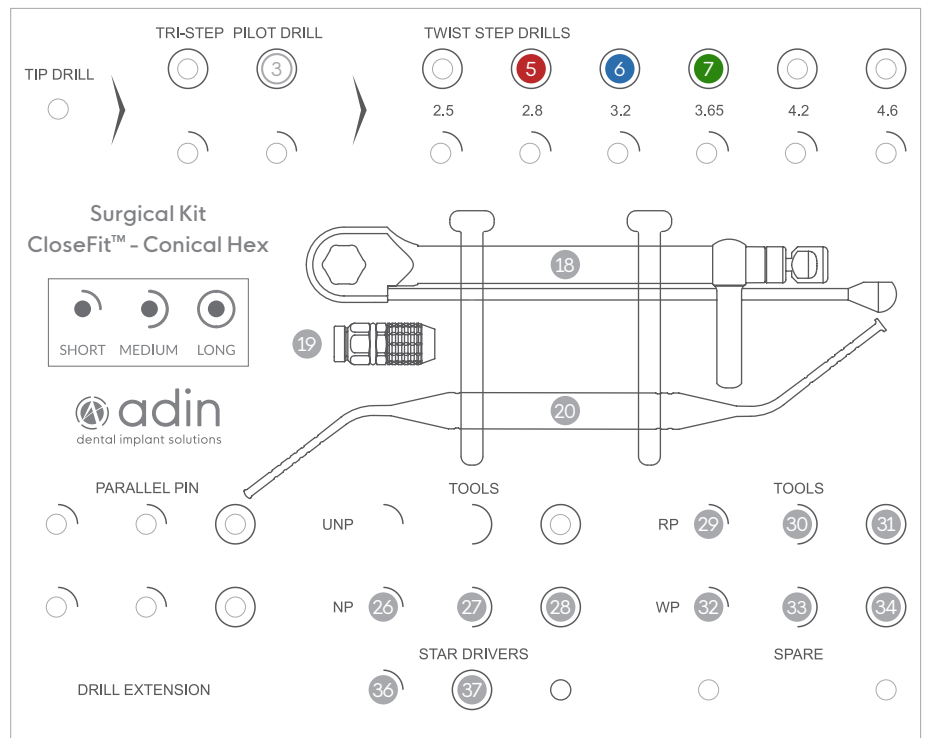

		Drills	Catalog No.
3		Pilot Drill 2mmD x 8-18mmL	DL1820
4		Twist Step Drill 2.3/2.8mmD x 8-18mmL	DL1828
5		Twist Step Drill 2.8/3.2mmD x 8-18mmL	DL1832
6		Twist Step Drill 3.2/3.6mmD x 8-18mmL	DL1836
7		Twist Step Drill 3.8/4.2mmD x 8-18mmL	DL1842

		Insertion Tools	Catalog No.
26		NP 2mm Hex Handpiece Adapter - Short	NP0068
27		NP 2mm Hex Handpiece Adapter - Medium	NP0071
28		NP 2mm Hex Handpiece Adapter - Long	NP0074
29		RP 2.25mm Hex Handpiece Adapter - Short	RP0068
30		RP 2.25mm Hex Handpiece Adapter - Medium	RP0071
31		RP 2.25mm Hex Handpiece Adapter - Long	RP0074
32		WP 2.65mm Hex Handpiece Adapter - Short	WP0068
33		WP 2.65mm Hex Handpiece Adapter - Medium	WP0071
34		WP 2.65mm Hex Handpiece Adapter - Long	WP0074

		Surgical Tools	Catalog No.
20		Wrench Ratchet	RS6100
21		Wrench Ratchet Surgical Instruments Handle	RA0050

		Hex Drivers	Catalog No.
36		Star Hand Driver - Short	RP0064
37		Star Hand Driver - Long	RP0004

Drills and Tools

Our DLC (Diamond Like Carbon) Tri-Step/Twist Step Surgical Drills are uniquely designed and coated to improve the surgical drilling process.

Tri-Step & Twist-Step DLC drills simplify the cutting process, save time and minimize risks.

Our improved DLC drill coating provides state-of-the-art hardness and slickness that increases lifespan of the drill, maintains sharpness for extended drilling and generates less heat, thereby reducing chances of heating the bone or complications arising from conventional drilling protocols.

The drills come in the following diameters (mm): 2.0, 2.5, 2.8, 3.2, 3.6, 4.2, 4.6, 5.2, 5.6

Specially designed for Adin's implants and suitable for their simple and convenient drilling protocol.

They are clearly and conveniently marked and can be used with or without drill stops.



Tri-Step drills









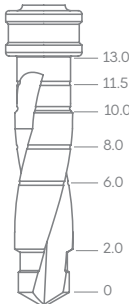

Adin's Tri-Step drills condense drilling protocols and avoid the need for using multiple drills throughout complex procedures.

Because friction at the cutting site is reduced, complications common with high speed drilling are decreased and faster & better recovery can occur.









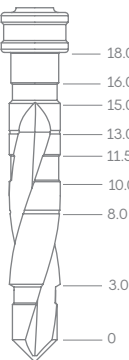

L		Ø	Size	Catalog No.
		1.8-3.2	Short	TD1511
		1.8-3.2	Long	TD2218

Twist Step drills

Short 6-13mm





L		Ø	Color	Catalog No.
		2.0	White	DL1320
		1.8-2.5	Purple	DL1325
		2.3-2.8	Red	DL1328
		2.8-3.2	Blue	DL1332
		3.2-3.6	Green	DL1336
		3.9	Pink	DL1339
		3.8-4.2	Black	DL1342
		4.2-4.6	Yellow	DL1346
		4.8-5.2	Brown	DL1352
		5.2-5.6	Grey	DL1356

Long 8-18mm











L		Ø	Color	Catalog No.
		2.0	White	DL1820
		1.8-2.5	Purple	DL1825
		2.3-2.8	Red	DL1828
		2.8-3.2	Blue	DL1832
		3.2-3.6	Green	DL1836
		3.9	Pink	DL1839
		3.8-4.2	Black	DL1842
		4.2-4.6	Yellow	DL1846
		4.8-5.2	Brown	DL1852
		5.2-5.6	Grey	DL1856

Surgical Tools















	Description	Catalog No.
	Surgical Torque Ratchet 35-100 Ncm	RS6111
	Prosthetic Torque Ratchet 15-35 Ncm	RS6112
	Wrench Ratchet	RS6100
	Surgical Driver	RS7001
	Depth Probe	RS6180



Hand & Torque Drivers Recommended Torque 25(Ncm)

	Description	Catalog No.
	Star Hand Driver 23.4mm *For Angled TMA/TMA prosthetic screw	RP0064
	Star Hand Driver 23.4mm *For Angled TMA/TMA prosthetic screw	RP0004
	TMA/FC Female Hand Hex Driver 22.4mm *For straight TMA/Flat connection	RS6193
	TMA/FC Female Hand Hex Driver 28.4mm *For straight TMA/Flat connection	RS6191
	RP 2.2mm Hex Torque Driver Short 20.0L	RP0067
	RP 2.2mm Hex Torque Driver-Long 25.0L	RP0066
	WP 2.6mm Torque Driver Short 20.0L	WP0067
	WP 2.6mm Torque Driver-Long 25.0L	WP0066
	Star Torque Driver Short 20.40L *For Angled TMA/TMA prosthetic screw	RP0065
	Star Torque Driver - Long 25.4L *For Angled TMA/TMA prosthetic screw	RP0005
	TMA/FC Hex Torque Driver - Short 20.0L *For straight TMA/Flat connection	RS6197





Handpiece Drivers Recommended Torque 35(Ncm)

	Description	Catalog No.
	TMA/FC Hex Torque Driver Long 25.0L For straight TMA/Flat connection	RS6196
	Torque Driver for Ball Attachment 16.7L	RS6090
	Wrench Ratchet Surgical Instruments Handle 16.7mm	RA0050
	RP 2.25mm Hex Handpiece Adapter Short 23.7L	RP0068
	RP 2.25mm Hex Handpiece Adapter Medium 27.6L	RP0071
	RP 2.25mm Hex Handpiece Adapter Long 36.0L	RP0074
	Star Handpiece Driver - Short 25.0L *For Angled TMA/TMA prosthetic screw	RP0018
	Star Handpiece Driver - Long 30.0L *For Angled TMA/TMA prosthetic screw	RP0019
	RP Handpiece Hex Adapter - Short 20.0L	RP0062
	RP Handpiece Hex Adapter - Long 25.0L	RP0072
	TMA/FC Hex Handpiece Adapter - Short 20.0L *For straight TMA/Flat connection	RS6194
	TMA/FC Hex Handpiece Adapter - Long 25.0L *For straight TMA/Flat connection	RS6195A

Tools

	Description	Catalog No.
	Parallel Pin 11mm	RS6150
	Parallel Pin 16mm	RS6155
	Drill Extension	RS9027

Osteotomes

	Description	Catalog No.
	Osteotome Handle	HA0074
	Osteotome Insert 2.0mmD	HA0061
	Osteotome Insert 2.8mmD	HA0064
	Osteotome Insert 3.25mmD	HA0067
	Osteotome Insert 3.65mmD	HA0070

Guided Surgery

The adinguide™ was created with you in mind, bringing the guided surgery world to your clinic.

The kits were specifically designed to support effortless procedures, accurate and predictable implant placement.

The ActiveFlow™ Irrigation Technology is a unique design that forces coolant through the guide to ensure irrigation reaches the bone and prevents overheating.

The adinguide™ drills are designed with carved channels which allow saline coolant from your hand-piece to stream through the sleeve directly into the osteotomy site while drilling.

Our uniquely designed drill kit is intuitive and easy to use by implant diameter and length.

The Tissue Punch and Pilot Drill allow for easy flapless access.

Keyless procedure enables easy handling and full visibility of surgical field.

Self-centering drills- controlled by a 5.5mm diameter cylinder at the top of each drill centers the drill in the guide's sleeve.

























Self-centering cylinder engages the sleeve before the drill engages the osteotomy in order to ensure correct positioning of the drill.

Built-in stoppers- ensure precise and accurate drilling to the desired depth.



Guided Surgery Kit Implants Drills GSK001



	Drills	Catalog No.		Drills	Catalog No.
1		GS5055	5		GS0638
2		GS0625	9		GS0838
3		GS0825	13		GS1038
7		GS1025	17		GS1138
11		GS1125	21		GS1338
15		GS1325	24		GS1638
19		GS1625	6		GS0646
4		GS0632	10		GS0846
8		GS0832	14		GS1046
12		GS1032	18		GS1146
16		GS1132	22		GS1346
20		GS1332	25		GS1646
23		GS1632			



For full
guided
procedure:



Guided Surgery Kit
CloseFit™ RP/WP
Implants Tools
GSK004

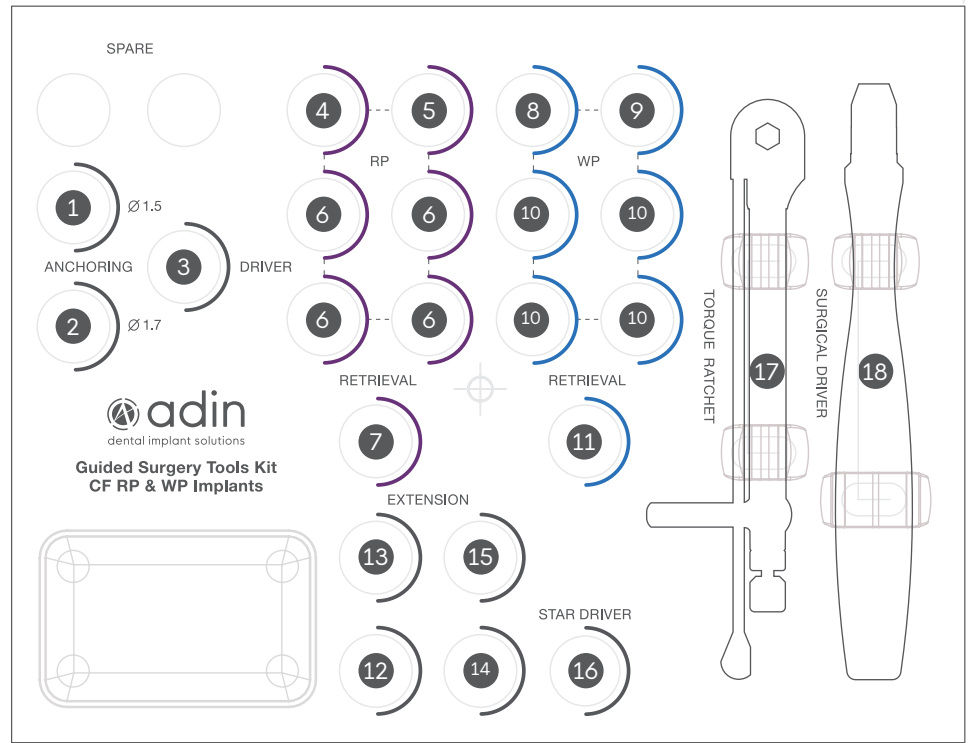

	Description	Catalog No.		Description	Catalog No.
	Anchoring Drill S-2.0, 2.0/1.5mmDx19mmL	GS1915		Manual Socket L10.5	GS0023
	Anchoring Drill S-2.0, 2.0/1.7mmDx19mmL	GS1917		Manual Socket L14.5	GS0024
	Handpiece Guide Fixation Screw Driver	GS0028		Handpiece Socket L10.5	GS0021
	Guided RP Handpiece Fixture Mount S-5.5	GS0041		Drill Extension	RS9027
	Guided RP Ratchet Fixture Mount S-5.5	GS0043		Star Hand Driver - Long	RP0004
	Guided RP Ratchet Fixture Mount S-5.5, Screw Retained	GS0037		Surgical Torque Ratchet 35-100 Ncm for hex 4mm	GS6111
	RP Ratchet retrieval tool	GS0046		Guide Fixation Screw Driver	GS0027
	Guided WP Handpiece Fixture Mount S-5.5	GS0042			
	Guided WP Ratchet Fixture Mount S-5.5	GS0044			
	Guided WP Ratchet Fixture Mount S-5.5, Screw Retained	GS0039			
	WP Ratchet retrieval tool	GS0047			



For full guided procedure:



CloseFit™ RP/WP Implant Platform



GS Tools Kit RS GSK001





5.5mmD Sleeve GS0055

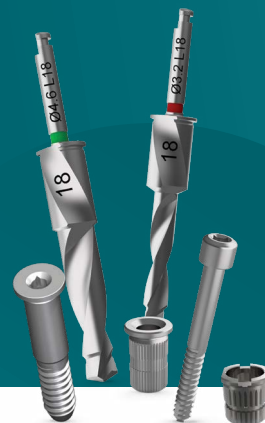

Additional Products Sold separately



18mm Drills

	Description	Catalog No.
	Drill S-5.5, 2.5/1.8mmDx18.0mmL	GS1825
	Drill S-3.3, 2.5/1.8mmDx18.0mmL	GSN1825

Accessories

	Description	Purchase Options	Catalog No.
	Guided Vertical Fixation Screw S-3.3	x3 pack	GS0006
	2.0mmD Anchoring Screw	x3 pack	GS1920
	2.0mmD Anchoring Sleeve	x3 pack	GS0020
	3.3mmD Narrow Implants Sleeve	x1 pack	GS0033
		x3 pack	GS0033x3
		x10 pack	GS0033x10
	5.5mmD Sleeve	x1 pack	GS0055
		x3 pack	GS0055x3
		x10 pack	GS0055x10

* Illustrations are not to scale

* Availability of the products in some places is limited and depends on local regulations.

* For more information, please contact your local representative.



Implant System

Our One™ implant system is a unique Monoblock solution designed for fast, convenient and immediate restoration, with minimal or no abutment preparation.

Featuring an integrated superstructure, the system's main advantage is the complete elimination of microbial leakage and colonization between implant and abutment, which leads to minimal gingival resorption.

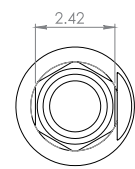
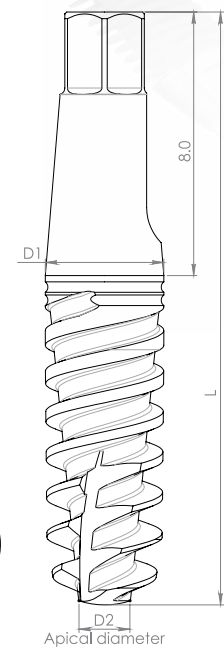
One™ narrow diameter implants are also highly suitable replacements for sites with limited interdental dimensions, such as maxillary lateral and mandibular incisors



	Description	Catalog No.
	Implant packed with : One Piece Torque Driver - Short	RS6025
	Additional part: One Piece Torque Driver - Long	RS6026

	Description	L	D1	Catalog No.
	Analog	20.60	3.00	RO0030
		20.60	3.30	RO0033
		20.60	3.60	RO0036
		20.60	4.25	RO0042
		20.60	5.00	RO0050

Recommended insertion torque up to 50 Ncm

	D1	L	D2	Catalog No.
	3.0	10.00	2.30	IO1030
		11.50	2.30	IO1130
		13.00	2.30	IO1330
		15.00	2.30	IO1530
	3.3	10.00	2.60	IO1033
		11.50	2.60	IO1133
		13.00	2.60	IO1333
		15.00	2.60	IO1533
	3.6	10.00	2.90	IO1036
		11.50	2.90	IO1136
		13.00	2.90	IO1336
		15.00	2.90	IO1536

	D1	L	D2	Catalog No.
	4.2	10.00	3.30	IO1042
		11.50	3.30	IO1142
		13.00	3.30	IO1342
		15.00	3.30	IO1542
	5.0	10.00	4.10	IO1050
		11.50	4.10	IO1150
		13.00	4.10	IO1350
		15.00	4.10	IO1550

Radiographic Template One™ | ASD0612

Recommended drilling speed up to 1200 rpm

Implant Diameter: $\varnothing 3.0$

$\varnothing 3.3$

$\varnothing 3.6$

$\varnothing 4.2$

$\varnothing 5.0$

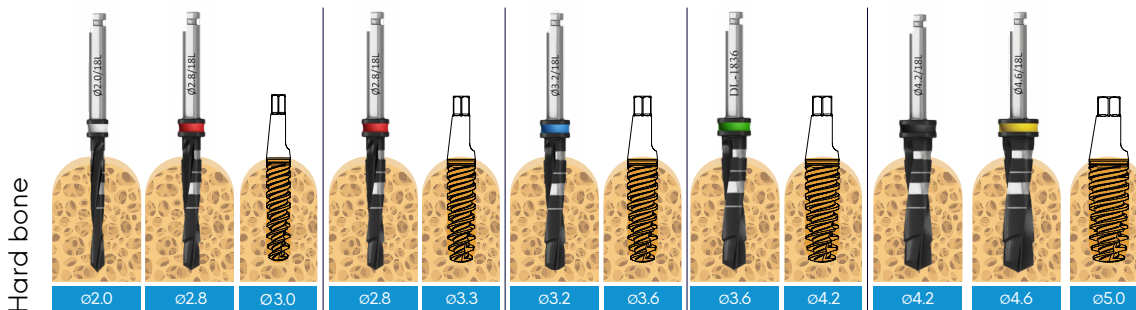

Implant Diameter: $\varnothing 3.0$

$\varnothing 3.3$

$\varnothing 3.6$

$\varnothing 4.2$

$\varnothing 5.0$

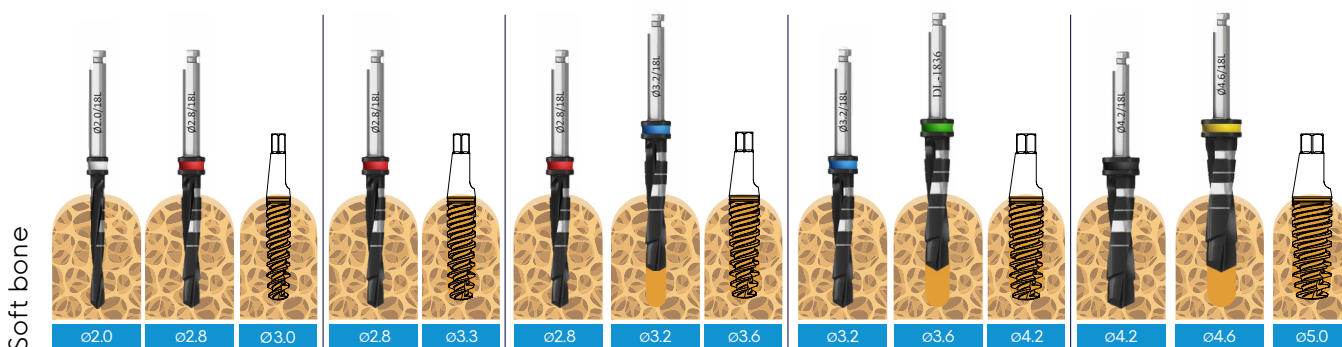

All measurements are in mm.

*For initial drilling, you may use Tri-step drill instead of $\varnothing 2$, $\varnothing 2.8$ and $\varnothing 3.2$ drills in sequence.

Note: (x.xx) Drill to the depth of the cortex only. All measurements are in mm.

⚠ CAUTION: The drill preparation is up to 1mm longer than the implant. * The drill apical step = 1.8mmD



Long Implants

Implant options up to 25mm in length

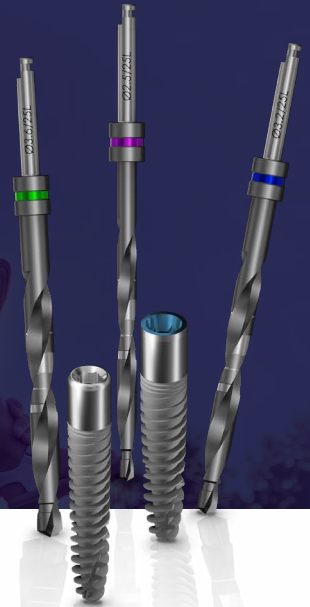

Adin's long implant range serves as an extension to the current Touareg-OS™ and CloseFit WP™ platform implants, allowing implant placement options up to 25mm in length.

In cases where more bone-to-implant contact is required, long implants may serve as a solution where the space allows for longer implants, alternatively, long implants can be used effectively as bi-cortical anchorage to compensate for lack of bone while still achieving implant stability in cases where implants of regular length might not.

Adin's long implant range carry specific features designed to enhance their performance such as narrow apex for limited spaces and a smooth neck to better suite gingival engagement.

Adin's unique and reliable OsseoFix™ surface treatment is utilized for both current Touareg™-OS and CloseFit™ WP platform long implants compatible drill set and depth probe have been designed to maximize ease of use and safety.

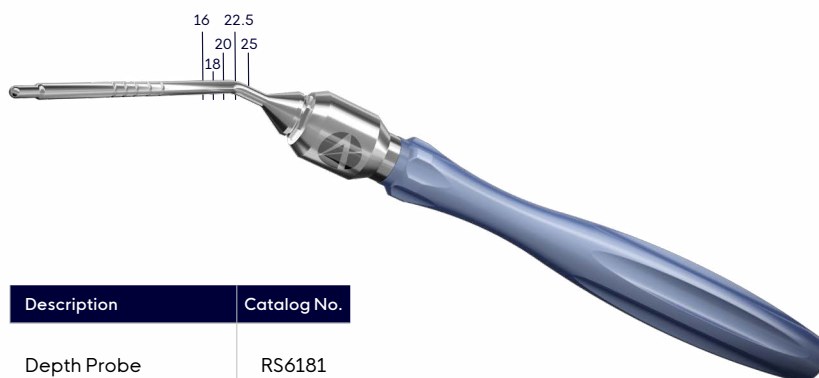

Description	Catalog No.
Depth Probe	RS6181
Surgical Driver	RS7001

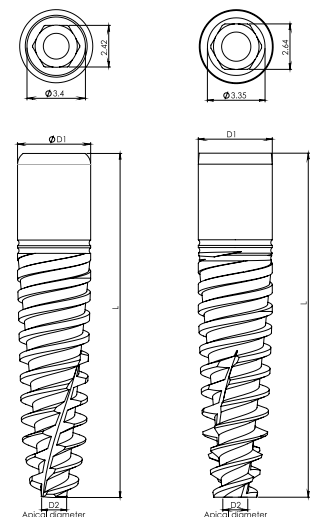

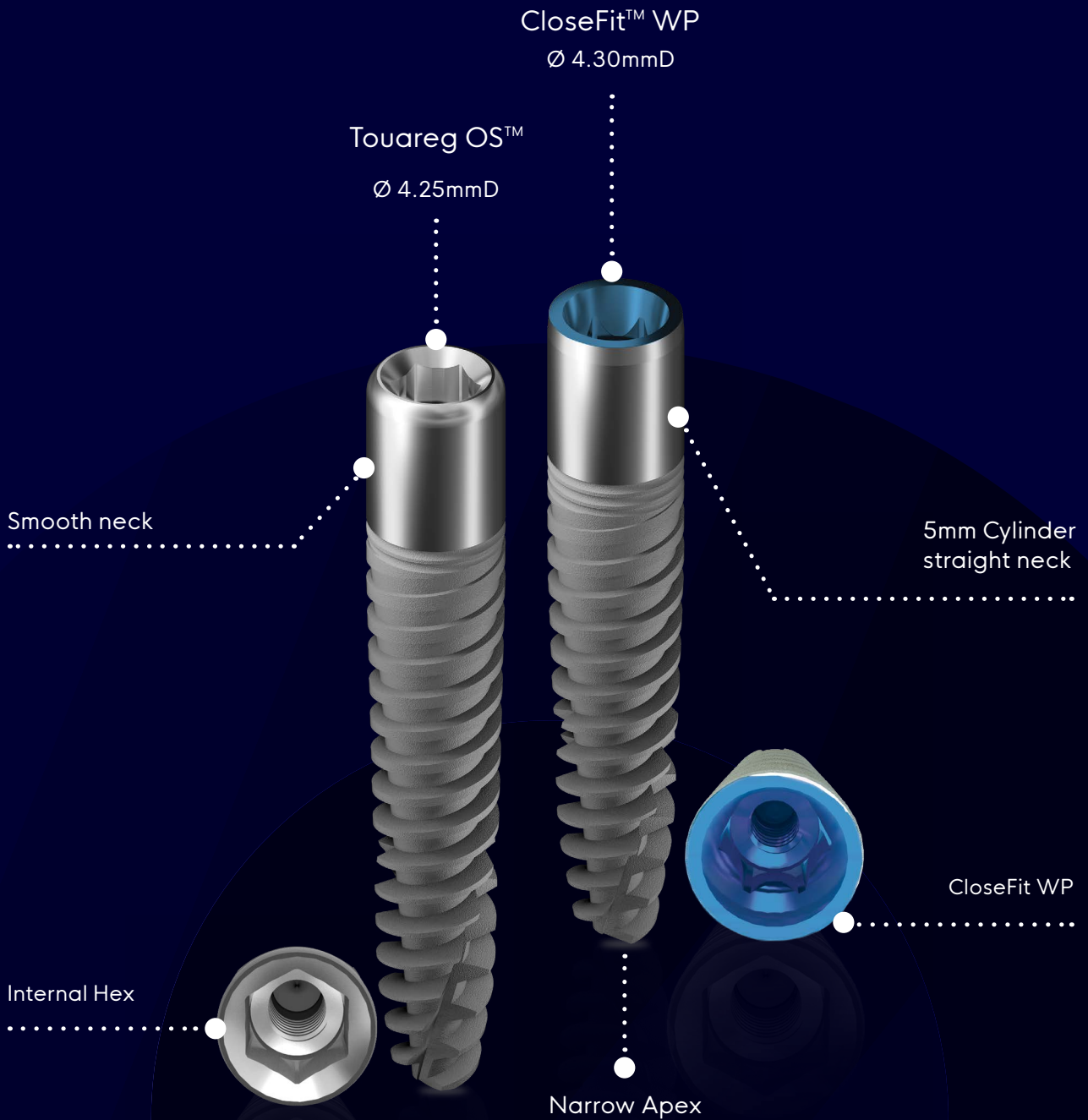

Touareg™- OS

Recommended insertion torque up to 50 Ncm

	D1	L	D2	Catalog No.
	4.2	20.0	1.5	ISF2042
		22.5	1.5	ISF2242
		25.0	1.5	ISF2542

CloseFit™ WP

Recommended insertion torque up to 50 Ncm

	D1	L	D2	Catalog No.
	4.3	20.0	1.5	ISPX2043
		22.5	1.5	ISPX2243
		25.0	1.5	ISPX2543

Touareg™-OS

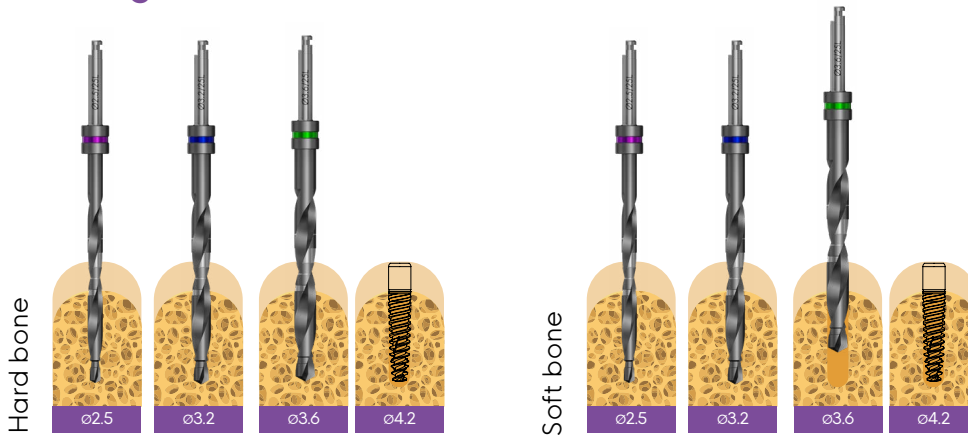

CloseFit™ WP

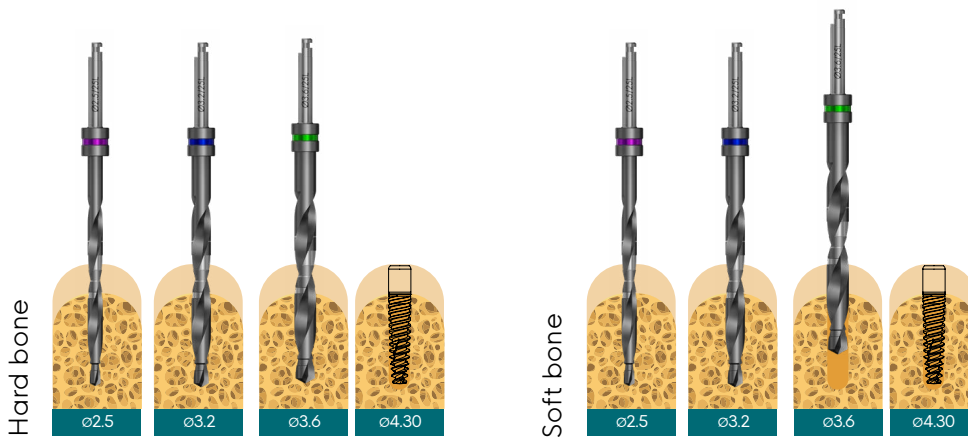

All measurements are in mm.

*For initial drilling, you may use Tri-step drill instead of ø2, ø2.8 and ø3.2 drills in sequence.

Note: (x.xx) Drill to the depth of the cortex only. All measurements are in mm.

⚠ CAUTION: The drill preparation is up to 1mm longer than the implant. * The drill apical step = 1.8mmD

Extra Long Drills 16-25mmL

L		Ø	Description	Catalog No.
		1.8/2.5 mmD	Extra-long pilot Drill	DL2525
		2.5/3.2 mmD	Extra-long twist Step Drill	DL2532
		3.2/3.6 mmD	Extra-long twist Step Drill	DL2536



Touareg™ OS Dental Implant

Adin Touareg™ OS Zygomatic Dental Implants are intended for immediate loading function. Implants are placed through the maxillary arch and anchored in the zygomatic bone. The Zygomatic implant provides support for prosthetic devices such as artificial teeth in order to restore the patient's chewing function in edentulous or partially edentulous patients.

Adin Touareg™ OS Zygomatic implants are intended:

For multi-unit reconstruction (TMA), with a rigid splinting of minimum two implants.

For an edentulous / full mouth restoration, should be used together with at least two standard implants.

Should be used only in patients with severe atrophic maxilla.

Intra-maxillary sinus and extra-maxillary sinus procedures and intended to be anchored in the zygoma bone.

One stage or two stage surgical operation.

Adin Touareg™ OS Zygomatic implants are Intended for ZAGA 0-3 cases only. Adin Touareg™ OS Zygomatic implants are NOT Intended for ZAGA 4 cases, where implant do not pass thru the maxillary alveolar bone.

Immediate loading function is applicable provided that stability requirements are satisfied.



	Ø	L	Catalog No.
	2.42 mm Internal Hex connection 4.2 mm	35.0mm	ISZT3542
		37.5mm	ISZT3742
		40.0mm	ISZT4042
		42.5mm	ISZT4242
		45.0mm	ISZT4542
		47.5mm	ISZT4742
		50.0mm	ISZT5042
		52.5mm	ISZT5242
		55.0mm	ISZT5542

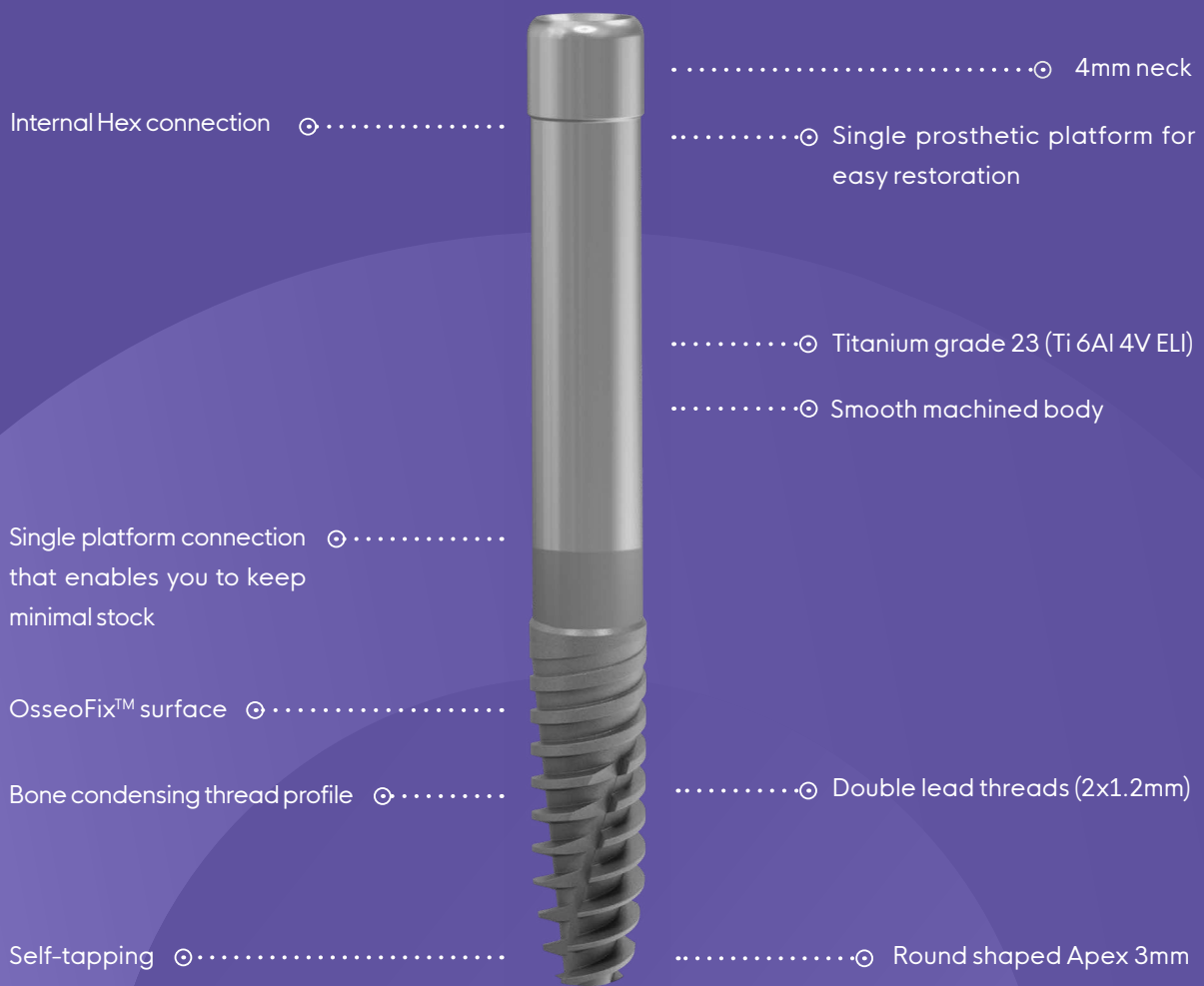

Drills Intended Use





Adin Touareg™ OS Zygomatic dental drills are bone cutting instruments intended for use in reconstructive oral surgery to drill or cut into the upper jaw and zygomatic bone to prepare the osteotomy for implant placement. Mark drill, used to mark the entry point for the pilot drill. Pilot drills (two-step coated drills), used for preparation of initial osteotomy to the desired depth.

Twist step drills (two-step coated drills), used for the gradual preparation of the final osteotomy to the desired diameter, for the placement of dental implant according to bone condition.

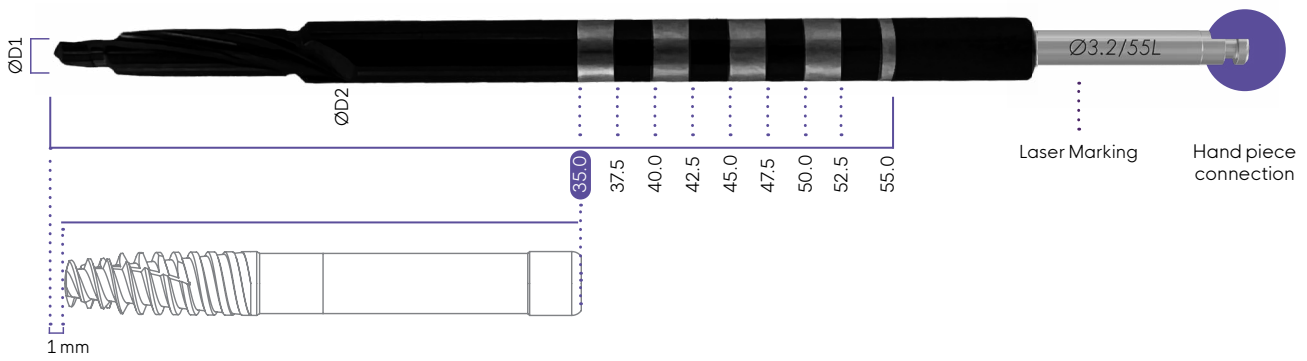
Drills Description and Characteristics

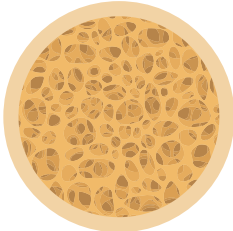
- Adin's drills are made of surgical stainless steel and are used with external irrigation
- Adin's drills are DLC coated to ensure performance
- Drills are available in diameters of Ø2.5, Ø 3.2 and Ø 3.6mm
- Drills have depth marks in lengths 35-55mm
- Step drill centered on previous hole
- Laser marking for drill length and diameter
- Ø2.4 spherical Mark drill



Maximum Speed	800-1200	600	600	600
				
	Mark Drill Ø2.4mm	Pilot Drill Ø2.5mm	Twist Drill Ø 3.2mm	Twist Drill Ø 3.6mm

CAUTION: The drill preparation is up to 1mm longer than implant.

Drills





	Description	Catalog No.
	Zygomatic Mark Drill 2.4mmD	DL5524
	Zygomatic Pilot Drill 1. 8/2.5mmD x 35-55mmL	DL5525
	Zygomatic Twist Step Drill 3.2/3.6mmD x 35-55mmL	DL5536
	Zygomatic Twist Step Drill 2.8/3.2mmD x 35-55mmL	DL5532

Zygomatic







Internal Hex Surgical Kit

ZGSK001



	Description	Catalog No.
	Zygomatic Mark Drill 2.4mmD	DL5524
	Zygomatic pilot Drill 1.8/2.5mmD x 35-55mmL	DL5525
	Zygomatic twist Step Drill 2.5/3.2mmD x 35-55mmL	DL5532
	Zygomatic twist Step Drill 3.2/3.6mmD x 35-55mmL	DL5536
	Depth Probe, Zygomatic 35-55mm	ZGDP01
	Surgical Driver	RS7001
	Zygomatic Diamond Burr 4.2mmDx35mmL, Medium	ZGDB3542M
	Zygomatic Diamond Burr 4.2mmDx35mmL, Coarse	ZGDB3542C
	Star torque Driver - Long	RP0005
	RS 2.4 Hex Torque Driver - Short	RS6011
	RS 2.4 Hex Torque Driver - Long	RS6012
	RS Hex Handpiece Adapter - Long	RS9029
	1.27 Hex Torque Driver - Short	RS6080
	Wrench Ratchet	RS6100
	Wrench Surgical Instruments Handle	RA0050

Tools

	Description	Catalog No.
	Star Torque Driver - Long	RP0005
	RS 2.4mm Hex Torque Driver - Short	RS6011
	RS 2.4mm Hex Torque Driver - Long	RS6012
	RS Hex Handpiece Adapter - Long	RS9029
	1.27mm Hex Torque Driver - Short	RS6080
	Wrench Ratchet	RS6100
	Wrench Ratchet Surgical Instruments Handle	RA0050

TMA™ - Multi Unit

Recommended Torque 35(Ncm)

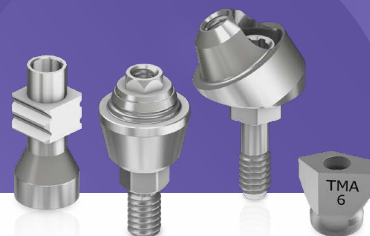

		Description	GH	Catalog No.
		RS Straight TMA 1mm	1.0	RS3731
		RS Straight TMA 2mm	2.0	RS3732
		RS Straight TMA 3mm	3.0	RS3733
		RS Straight TMA 4mm	4.0	RS3729
		RS Straight TMA 5mm	5.0	RS3730
		RS Angled TMA 17° 2mm	2.0	RS3734
		RS Angled TMA 30° 3mm	3.0	RS3735
		RS Angled TMA 17° 3mm	3.0	RS3737
		RS Angled TMA 30° 4mm	4.0	RS3738
		RS Angled TMA 45° 4mm	4.0	RS3736
		RS Angled TMA 52° 5mm	4.9	RS3739
		RS Angled TMA 60° 5mm	5.8	RS3740





Transfers

	Description	L	D1	D2	Catalog No.
	TMA Impression Coping Open Tray	11.0	4.9	3.1	RS5006
	TMA Closed Tray Transfer	8.0	4.9	4.1	RS5011
	TMA Healing Cup	5.5	4.9	3.5	RS5005
		7.0	4.9	3.5	RS5003





Analogs

	Description	L	D1	D2	Catalog No.
	TMA Abutment Replica	16.8	3.35	-	RS5004
	TMA Digital Model Replica Recommended torque 15(Ncm)	12.0	4.9	3.8	RS1001
	TMA Scan Body	6.0	4.9		TM0006
		9.0	4.9		TM0009

Screws



	Description	L	D1	Catalog No.		Description	L	D1	Catalog No.
	RS Retaining Screw for Angled TMA	6.1	2.4	RS3403		RS Retaining Screw for TMA 1mm	7.8	3.1	RS3406
						RS Retaining Screw for TMA 2mm	8.8	3.1	RS3407
	TMA Prosthetic Screw 15(Ncm)	4.1	2.1	RS3404		RS Retaining Screw for TMA 3mm	9.8	3.1	RS3408
						RS Retaining Screw for TMA 4mm	10.8	3.1	RS3409
						RS Retaining Screw for TMA 5mm	11.8	3.1	RS3412
	TMA Screw for Open Tray Transfer	14	2.1	RS5008		TMA Screw for Closed Tray Transfer	6.8	2.5	RS5009

TMA Prosthetics



	Description	L	D1	D2	H	Catalog No.		Description	L	D1	D2	Catalog No.
	TMA Titanium Temporary	12.0	4.9	3.5	10.5	RS4900		TMA Cementing Cone, low profile	4.9	5.5	3.2	TM0011
	TMA Plastic Casting Sleeve /Prosthetic Screw	12.0	4.9	3.3	10.5	RS5001		TMA Cementing Cone	4.9	5.5	2.9	TM0010

Tool Drivers | For Angled TMA/TMA Prosthetic Screws







For Angled TMA/TMA prosthetic screw

	Description	L	Catalog No.
	Star Hand Driver Short	23.4	RP0064
	Star Hand Driver Long	28.4	RP0004
	Star Torque Driver-Short	20.4	RP0065
	Star Torque Driver-Long	25.4	RP0005

For straight TMA

	Description	L	Catalog No.
	TMA/FC Hex Torque Driver - Short	20	RS6197
	TMA/FC Hex Torque Driver - Long	25	RS6196
	TMA/FC Female Hand Hex Driver-Short	22.4	RS6193
	TMA/FC Female Hand Hex Driver-Long	28.4	RS6191
	TMA/FC Hex Handpiece Adapter-Short	20	RS6194
	TMA/FC Hex Handpiece Adapter-Long	25	RS6195A









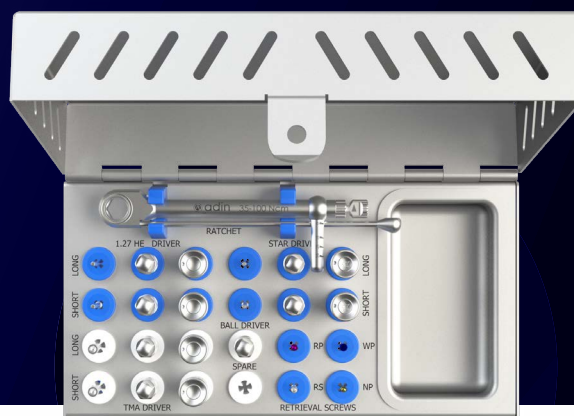















TMA Gauges

	Description	Catalog No.		Description	Catalog No.		Description	Catalog No.
	RS Angled Trans Mucosal Abutment Gauge 60°	RS3745		RS Angled Trans Mucosal Abutment Gauge 52°	RS3744		RS Angled Trans Mucosal Abutment Gauge 45°	RS3743
	RS Angled Trans Mucosal Abutment Gauge 30°	RS3742		RS Angled Trans Mucosal Abutment Gauge 17°	RS3741		RS Angled Trans Mucosal Abutment Gauge Kit	RS3747

Prosthetic Kit

PK6300



Prosthetic Kit	Description	L	Catalog No.
	1.27 Hex Driver for Handpiece - Long	30.0	RS9035
	1.27 Hex Driver for Handpiece - Short	25.0	RS9030
	TMA/FC Hex Handpiece Adapter - Long	25.0	RS6195A
	TMA/FC Hex Handpiece Adapter - Short	20.0	RS6194
	1.27 Hex Torque Driver - Long	25.4	RS6082
	1.27 Hex Torque Driver - Short	20.4	RS6080
	TMA/FC Hex Torque Driver - Long	25.0	RS6196
	TMA/FC Hex Torque Driver - Short	20.0	RS6197
	1.27 Hex Hand Driver - Medium	28.4	RS6094
	1.27 Hex Hand Driver - Short	22.4	RS6095
	TMA/FC Female Hand Hex Driver - Short	22.4	RS6193
	TMA/FC Female Hand Hex Driver - Long	28.4	RS6191
	Star Handpiece Driver - Long	30.0	RP0019
	Star Handpiece Driver - Short	25.0	RP0018
	Torque Driver for Ball Attachment	14.4	RS6090
	Star Torque Driver - Long	25.4	RP0005
	Star Torque Driver - Short	20.4	RP0065
	RP Retrieval Screw for Abutments	12.2	RP3401
	RS Retrieval Screw For Abutments	15.0	RS3401
	Star Hand Driver - Long	28.4	RP0004
	Star Hand Driver - Short	23.4	RP0064
	WP Retrieval Screw for Abutments	12.3	WP3401
	NP Retrieval Screw for Abutments	13.4	NP0014
	Prosthetic Torque Ratchet 15-35 Ncm	98.0	RS6112

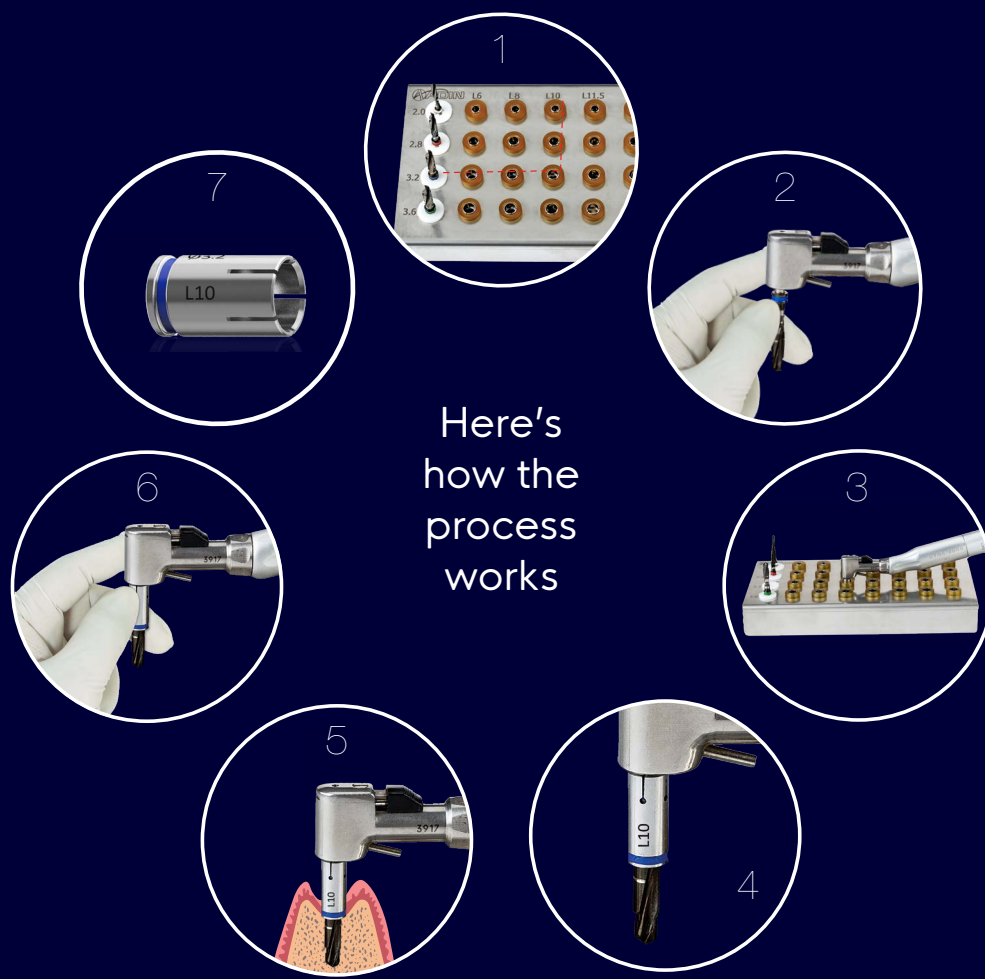

Each Drill Stops is marked with width and length,
note that some are suitable for long and short drill according to the following:
L: Drill length for long drill (18 mm)
S: Drill length for short drill (13 mm)



Drill Stop Kit

S1001 | Regular Long



Drills



Catalog No. DL1820

L

Pilot Drill 2mmD x 8-18mmL

35.5



Catalog No. DL1828

L

Twist Step Drill 2.3/2.8mmD x 8-18mmL

35.5



Catalog No. DL1832

L

Twist Step Drill 2.8/3.2mmD x 8-18mmL

35.5



Catalog No. DL1836

L

Twist Step Drill 3.2/3.6mmD x 8-18mmL

35.5

Stoppers

L

Catalog No.

Drill Stopper for Long L6 1820	6.0	S1820L6
Drill Stopper for Long L8 1820	8.0	S1820L8
Drill Stopper for Long L10 1820	10.0	S1820L10
Drill Stopper for Long L11.5 1820	11.5	S1820L11.5
Drill Stopper for Long L13/Short L8 1820	13.0	S1820L13
Drill Stopper for Long L15/Short L10 1820	15.0	S1820L15
Drill Stopper for Long L16 1820	16.0	S1820L16
Drill Stopper for Long L6 1828	6.0	S1828L6
Drill Stopper for Long L8 1828	8.0	S1828L8
Drill Stopper for Long L10 1828	10.0	S1828L10
Drill Stopper for Long L11.5 1828	11.5	S1828L11.5
Drill Stopper for Long L13/Short L8 1828	13.0	S1828L13
Drill Stopper for Long L15/Short L10 1828	15.0	S1828L15
Drill Stopper for Long L16 1828	16.0	S1828L16
Drill Stopper for Long L6 1832	6.0	S1832L6
Drill Stopper for Long L8 1832	8.0	S1832L8
Drill Stopper for Long L10 1832	10.0	S1832L10
Drill Stopper for Long L11.5 1832	11.5	S1832L11.5
Drill Stopper for Long L13/Short L8 1832	13.0	S1832L13
Drill Stopper for Long L15/Short L10 1832	15.0	S1832L15
Drill Stopper for Long L16 1832	16.0	S1832L16
Drill Stopper for Long L6 1836	6.0	S1836L6
Drill Stopper for Long L8 1836	8.0	S1836L8
Drill Stopper for Long L10 1836	10.0	S1836L10
Drill Stopper for Long L11.5 1836	11.5	S1836L11.5
Drill Stopper for Long L13/Short L8 1836	13.0	S1836L13
Drill Stopper for Long L15/Short L10 1836	15.0	S1836L15
Drill Stopper for Long L16 1836	16.0	S1836L16

Drill Stop Kit

S1002 | Wide Long



Drills



Catalog No. DL1842

L

Twist Step Drill 3.8/4.2mmD x 8-18mmL

35.5



Catalog No. DL1846

L

Twist Step Drill 4.2/4.6mmD x 8-18mmL

35.5



Catalog No. DL1852

L

Twist Step Drill 4.8/5.2mmD x 8-18mmL

35.5



Catalog No. DL1856

L

Twist Step Drill 5.2/5.6mmD x 8-18mmL

35.5

Stoppers

L

Catalog No.

Drill Stopper for Long L6 1842	6.0	S1842L6
Drill Stopper for Long L8 1842	8.0	S1842L8
Drill Stopper for Long L10 1842	10.0	S1842L10
Drill Stopper for Long L11.5 1842	11.5	S1842L11.5
Drill Stopper for Long L13/Short L8 1842	13.0	S1842L13
Drill Stopper for Long L15/Short L10 1842	15.0	S1842L15
Drill Stopper for Long L16 1842	16.0	S1842L16
Drill Stopper for Long L6 1846	6.0	S1846L6
Drill Stopper for Long L8 1846	8.0	S1846L8
Drill Stopper for Long L10 1846	10.0	S1846L10
Drill Stopper for Long L11.5 1846	11.5	S1846L11.5
Drill Stopper for Long L13/Short L8 1846	13.0	S1846L13
Drill Stopper for Long L15/Short L10 1846	15.0	S1846L15
Drill Stopper for Long L16 1846	16.0	S1846L16
Drill Stopper for Long L6 1852	6.0	S1852L6
Drill Stopper for Long L8 1852	8.0	S1852L8
Drill Stopper for Long L10 1852	10.0	S1852L10
Drill Stopper for Long L11.5 1852	11.5	S1852L11.5
Drill Stopper for Long L13/Short L8 1852	13.0	S1852L13
Drill Stopper for Long L15/Short L10 1852	15.0	S1852L15
Drill Stopper for Long L16 1852	16.0	S1852L16
Drill Stopper for Long L6 1856	6.0	S1856L6
Drill Stopper for Long L8 1856	8.0	S1856L8
Drill Stopper for Long L10 1856	10.0	S1856L10
Drill Stopper for Long L11.5 1856	11.5	S1856L11.5
Drill Stopper for Long L13/Short L8 1856	13.0	S1856L13
Drill Stopper for Long L15/Short L10 1856	15.0	S1856L15
Drill Stopper for Long L16 1856	16.0	S1856L16

Drill Stop Kit

S1003 | Regular Short



Drills



Catalog No. DL1320

L

Pilot Drill 2mmD x 6-13mmL

30.5



Catalog No. DL1328

L

Twist Step Drill 2.3/2.8mmD x 6-13mmL

30.5



Catalog No. DL1332

L

Twist Step Drill 2.8/3.2mmD x 6-13mmL

30.5



Catalog No. DL1336

L

Twist Step Drill 3.2/3.6mmD x 6-13mmL

30.5

Stoppers

L

Catalog No.

Drill Stopper for Short L6 1320	6.0	S1320L6
Drill Stopper for Short L11.5 1320	11.5	S1320L11.5
Drill Stopper for Short L6 1328	6.0	S1328L6
Drill Stopper for Short L11.5 1328	11.5	S1328L11.5
Drill Stopper for Short L6 1332	6.0	S1332L6
Drill Stopper for Short L11.5 1332	11.5	S1332L11.5
Drill Stopper for Short L6 1336	6.0	S1336L6
Drill Stopper for Short L11.5 1336	11.5	S1336L11.5
Drill Stopper for Long L13/Short L8 1820	13.0	S1820L13
Drill Stopper for Long L15/Short L10 1820	15.0	S1820L15
Drill Stopper for Long L13/Short L8 1828	13.0	S1828L13
Drill Stopper for Long L15/Short L10 1828	15.0	S1828L15
Drill Stopper for Long L13/Short L8 1832	13.0	S1832L13
Drill Stopper for Long L15/Short L10 1832	15.0	S1832L15
Drill Stopper for Long L13/Short L8 1836	13.0	S1836L13
Drill Stopper for Long L15/Short L10 1836	15.0	S1836L15

Description	Catalog No.	Page No.
1.27 Hex Driver for Handpiece-Long	RS9035	29, 39, 62, 99, 139, 166
1.27 Hex Driver for Handpiece-Short	RS9030	29, 39, 62, 99, 139, 166
1.27 Hex Hand Driver - Medium	RS6094	24, 29, 31, 32, 33, 39, 42, 166
1.27 Hex Hand Driver - Short	RS6095	24, 29, 31, 32, 33, 39, 42, 166
1.27 Hex Hand Driver 46.4mm	RS6097	39
1.27 Hex torque driver-Long	RS6082	29, 38, 62, 70, 99, 139, 162, 163, 166
1.27mm Hex Torque Driver - Short	RS6080	29, 38, 62, 70, 99, 139, 162, 163, 166
12 Manual Socket L14.5 GS0024	GS0024	42, 74, 112, 152
2.0mmD Anchoring Screw x3 pack	GS1920	43, 75, 113, 153
2.0mmD Anchoring Sleeve x3 pack	GS0020	113
5.5mmD Sleeve	GS0055	41, 42, 43, 73, 75, 151, 153
Additional part: One Piece Torque Driver - Long	RS6026	154
Anchoring Drill S-2.0, 2.0/1.5mmDx19mmL	GS1915	42, 74, 112, 152
Anchoring Drill S-2.0, 2.0/1.7mmDx19mmL	GS1917	42, 74, 112, 152
Angulated Screw Extractor Hand Driver	RP6400	23, 56, 93, 133
Angulated Star Screw Hand Driver - Long 28.4L	RP6402	23, 56, 93, 133
Angulated Star Screw Hand Driver - Short 23.4L	RP6401	23, 56, 93, 133
Angulated Star Screw Handpiece Driver - Extra Short 20.0L	RP6405	23, 56, 93, 133
Angulated Star Screw Handpiece Driver - Long 30.0L	RP6407	23, 56, 93, 133
Angulated Star Screw Handpiece Driver - Short 25.0L	RP6406	23, 56, 93, 133
Angulated Star Screw Torque Driver - Short 17.0L	RP6403	23, 56, 93, 133
Ball Attachment Replica	RS5740	27, 60, 97, 137
Close Tray Screw	RS5126	18
Close Tray Screw	RS5127	18
CloseFit™ NP 3.0D 10L	ISPNP1030	80
CloseFit™ NP 3.0D 11.5L	ISPNP1130	80
CloseFit™ NP 3.0D 13L	ISPNP1330	80
CloseFit™ NP 3.0D 16L	ISPNP1630	80
CloseFit™ NP 3.0D 18L	ISPNP1830	80
CloseFit™ RP 3.5D 10L	ISPX1035	117
CloseFit™ RP 3.5D 13L	ISPX1335	117
CloseFit™ RP 3.5D 15L	ISPX1535	117
CloseFit™ RP 3.5D 18L	ISPX1835	117
CloseFit™ RP 3.5D 8L	ISPX0835	117
CloseFit™ UNP 2.75D 10L	ISPUNP1027	79
CloseFit™ UNP 2.75D 11.5L	ISPUNP1127	79
CloseFit™ UNP 2.75D 13L	ISPUNP1327	79
CloseFit™ UNP 2.75D 16L	ISPUNP1627	79
CloseFit™ UNP 2.75D 18L	ISPUNP1827	79
CloseFit™ WP 4.3D 10L	ISPX1043	117
CloseFit™ WP 4.3D 13L	ISPX1343	117
CloseFit™ WP 4.3D 15L	ISPX1543	117
CloseFit™ WP 4.3D 18L	ISPX1843	117
CloseFit™ WP 4.3D 20L	ISPX2043	157
CloseFit™ WP 4.3D 22L	ISPX2243	157
CloseFit™ WP 4.3D 25L	ISPX2543	157
CloseFit™ WP 4.3D 8L	ISPX0843	117

Description	Catalog No.	Page No.
CloseFit™ WP 5D 10L	ISPX1049	117
CloseFit™ WP 5D 13L	ISPX1349	117
CloseFit™ WP 5D 15L	ISPX1549	117
CloseFit™ WP 5D 18L	ISPX1849	117
CloseFit™ WP 5D 8L	ISPX0849	117
C-Type Ti Base NP Abutment, GH 4mm Engaged	TB02444	92
C-Type Ti Base RP Abutment, GH 4mm Engaged	TB03444	130
C-Type Ti Base RS Abutment, GH 4mm Engaged	TB04444	22
C-Type Ti Base RS Abutment, GH 4mm Engaged Wide	TB04444W	22
C-Type Ti Base RS Abutment, GH 4mm Non Engaged	TB04445	22
C-Type Ti Base RS Abutment, GH 4mm Non Engaged Wide	TB04445W	22
C-Type Ti Base UniFit Abutment GH 4mm Engaged	TB07444	55
C-Type Ti Base UniFit Abutment GH 4mm Engaged Wide	TB07444W	55
C-Type Ti Base WP Abutment, GH 4mm Engaged	TB05444	131
C-Type Ti Base WP Abutment, GH 4mm Engaged Wide	TB05444W	131
Depth Probe	RS6180	31, 32, 36, 64, 65, 68, 101, 102, 106, 141, 142, 146
Depth Probe	RS6181	156
Depth Probe, Zygomatic 35-55mm	ZGDP01	162
Drill Extension	RS9027	31, 32, 37, 42, 64, 65, 69, 101, 102, 109, 112, 141, 142, 149, 152
Drill S-3.3, 2.5/1.8mmDx11.5mmL	GSN1125	112
Drill S-5.5, 2.5/1.8mmDx11.5mmL	GS1125	41, 73, 151
Drill S-5.5, 2.5/1.8mmDx13.0mmL	GS1325	41, 73, 151
Drill S-5.5, 2.5/1.8mmDx18.0mmL	GS1825	43, 75, 113, 153
Drill S-5.5, 2.5/1.8mmDx8.0mmL	GS0825	41, 73, 151
Drill S-5.5, 3.2/2.5mmDx10.0mmL	GS1032	41, 73, 151
Drill S-5.5, 3.2/2.5mmDx13.0mmL	GS1332	41, 73, 151
Drill S-5.5, 3.2/2.5mmDx16.0mmL	GS1632	41, 73, 151
Drill S-5.5, 3.2/2.5mmDx18.0mmL	GS1832	43, 75
Drill S-5.5, 3.2/2.5mmDx6.25mmL	GS0632	41, 73, 151
Drill S-5.5, 3.2/2.5mmDx8.0mmL	GS0832	41, 73, 151
Drill S-5.5, 3.85/3.2mmDx10.0mmL	GS1038	41, 73, 151
Drill S-5.5, 3.85/3.2mmDx13.0mmL	GS1338	41, 73, 151
Drill S-5.5, 3.85/3.2mmDx16.0mmL	GS1638	41, 73, 151
Drill S-5.5, 3.85/3.2mmDx18.0mmL	GS1838	43, 75
Drill S-5.5, 3.85/3.2mmDx6.25mmL	GS0638	41, 73, 151
Drill S-5.5, 3.85/3.2mmDx8.0mmL	GS0838	41, 73, 151
Drill S-5.5, 4.6/3.85mmDx13.0mmL	GS1346	41, 73, 151
Drill S-5.5, 4.6/3.85mmDx16.0mmL	GS1646	41, 73, 151
Drill S-5.5, 4.6/3.85mmDx18.0mmL	GS1846	43, 75
Drill S-5.5, 4.6/3.85mmDx6.25mmL	GS0646	41, 73, 151
Drill S-5.5, 4.6/3.85mmDx8.0mmL	GS0846	41, 73, 151
Drill Stopper for Long L10 1820	S1820L10	168
Drill Stopper for Long L10 1828	S1828L10	168
Drill Stopper for Long L10 1832	S1832L10	168
Drill Stopper for Long L10 1836	S1836L10	168
Drill Stopper for Long L10 1842	S1842L10	169
Drill Stopper for Long L10 1846	S1846L10	169
Drill Stopper for Long L11.5 1820	S1820L11.5	168

Description	Catalog No.	Page No.
Drill Stopper for Long L11.5 1828	S1828L11.5	168
Drill Stopper for Long L11.5 1832	S1832L11.5	168
Drill Stopper for Long L11.5 1836	S1836L11.5	168
Drill Stopper for Long L11.5 1842	S1842L11.5	169
Drill Stopper for Long L11.5 1846	S1846L11.5	169
Drill Stopper for Long L13/Short L8 1820	S1820L13	168
Drill Stopper for Long L13/Short L8 1828	S1828L13	168
Drill Stopper for Long L13/Short L8 1832	S1832L13	168
Drill Stopper for Long L13/Short L8 1836	S1836L13	168
Drill Stopper for Long L13/Short L8 1842	S1842L13	169
Drill Stopper for Long L13/Short L8 1846	S1846L13	169
Drill Stopper for Long L15/Short L10 1820	S1820L15	168
Drill Stopper for Long L15/Short L10 1828	S1828L15	168
Drill Stopper for Long L15/Short L10 1832	S1832L15	168
Drill Stopper for Long L15/Short L10 1836	S1836L15	168
Drill Stopper for Long L15/Short L10 1842	S1842L15	169
Drill Stopper for Long L15/Short L10 1846	S1846L15	169
Drill Stopper for Long L16 1820	S1820L16	168
Drill Stopper for Long L16 1828	S1828L16	168
Drill Stopper for Long L16 1832	S1832L16	168
Drill Stopper for Long L16 1836	S1836L16	168
Drill Stopper for Long L16 1842	S1842L16	169
Drill Stopper for Long L16 1846	S1846L16	169
Drill Stopper for Long L6 1820	S1820L6	168
Drill Stopper for Long L6 1828	S1828L6	168
Drill Stopper for Long L6 1836	S1836L6	168
Drill Stopper for Long L6 1842	S1842L6	169
Drill Stopper for Long L6 1846	S1846L6	169
Drill Stopper for Long L8 1820	S1820L8	168
Drill Stopper for Long L8 1828	S1828L8	168
Drill Stopper for Long L8 1836	S1836L8	168
Drill Stopper for Long L8 1842	S1842L8	169
Drill Stopper for Long L8 1846	S1846L8	169
Drill Stopper for Long L6 1832	S1832L6	168
Drill Stopper for Long L8 1832	S1832L8	168
Drill Stopper for Short L11.5 1320	S1320L11.5	170
Drill Stopper for Short L11.5 1328	S1328L11.5	170
Drill Stopper for Short L11.5 1332	S1332L11.5	170
Drill Stopper for Short L11.5 1336	S1336L11.5	170
Drill Stopper for Short L11.5 1342	S1342L11.5	171
Drill Stopper for Short L11.5 1346	S1346L11.5	171
Drill Stopper for Short L11.5 1352	S1352L11.5	171
Drill Stopper for Short L11.5 1356	S1356L11.5	171
Drill Stopper for Short L6 1320	S1320L6	170
Drill Stopper for Short L6 1328	S1328L6	170
Drill Stopper for Short L6 1332	S1332L6	170
Drill Stopper for Short L6 1336	S1336L6	170
Drill Stopper for Short L6 1342	S1342L6	171
Drill Stopper for Short L6 1346	S1346L6	171

Description	Catalog No.	Page No.
Drill Stopper for Short L6 1352	S1352L6	171
Drill Stopper for Short L6 1356	S1356L6	171
Extra-long pilot Drill	DL2525	158
Extra-long twist Step Drill	DL2532	158
Extra-long twist Step Drill	DL2536	158
Grip Block Out Spacer 4 Pack	RS6424	29, 62, 99, 139
Grip core tool	RS6200	29, 62, 99, 139
Grip Extended Range processing set	RS6427	28, 61, 98, 138
Grip Extended Range Retention 4 Pack Extra Light	RS6421	29, 62, 99, 139
Grip Extended Range Retention 4 Pack Light	RS6422	29, 62, 99, 139
Grip Extended Range Retention 4 Pack Regular	RS6423	29, 62, 99, 139
Grip Extended Range Retention 4 Pack Zero	RS6420	29, 62, 99, 139
Grip Impression Coping 4 Pack	RS6414	29, 62, 99, 139
Grip NP Abutment 1mm	NP0051	98
Grip NP Abutment 1mm	NP0052	98
Grip NP Abutment 1mm	NP0053	98
Grip NP Abutment 1mm	NP0054	98
Grip NP Abutment 1mm	NP0055	98
Grip NP Abutment 1mm	NP0056	98
Grip Processing 20 Pack	RS6416	29, 62, 99, 139
Grip Processing 4 Pack	RS6415	29, 62, 99, 139
Grip Processing Set	RS6426	28, 61, 98, 138
Grip Retention 4 Pack Extra Light	RS6417	29, 62, 99, 139
Grip Retention 4 Pack Light	RS6418	29, 62, 99, 139
Grip Retention 4 Pack Regular	RS6419	29, 62, 99, 139
Grip RP Abutment 1mm	RP0038	138
Grip RP Abutment 2mm	RP0057	138
Grip RP Abutment 2mm	RP0058	138
Grip RP Abutment 2mm	RP0059	138
Grip RP Abutment 2mm	RP0060	138
Grip RP Abutment 2mm	RP0061	138
Grip RS Abutment 1mm	RS3037	28
Grip RS Abutment 2mm	RS3032	28
Grip RS Abutment 3mm	RS3033	28
Grip RS Abutment 4mm	RS3034	28
Grip RS Abutment 5mm	RS3035	28
Grip RS Abutment 6mm	RS3036	28
Grip UF Abutment 1mm	UF0101	61
Grip UF Abutment 2mm	UF0102	61
Grip UF Abutment 3mm	UF0103	61
Grip UF Abutment 4mm	UF0104	61
Grip UF Abutment 5mm	UF0105	61
Grip UF Abutment 6mm	UF0106	61
Grip WP Abutment 1mm	WP0063	138
Grip WP Abutment 2mm	WP0057	138
Grip WP Abutment 3mm	WP0058	138
Grip WP Abutment 4mm	WP0059	138
Grip WP Abutment 5mm	WP0060	138
Grip WP Abutment 6mm	WP0061	138

Description	Catalog No.	Page No.
Grip™ for Bar, M2 thread	RS0101	28, 61, 98, 138
Grip™ Replica 4 Pack	RS2508	29, 62, 99, 139
GS Accessories Kit - RP&WP	GSK004	151, 152
GS Tools Kit RS	GSK001	42, 73, 74, 151, 152
Guide Fixation Screw Driver	GS0027	42, 74, 112, 152
Guided NP Handpiece Fixture Mount S-3.3	GS0017	112
Guided NP Ratchet Fixture Mount S-3.3	GS0019	112
Guided NP Ratchet Fixture Mount S-3.3, Screw Retained	GS0013	112
Guided RP Handpiece Fixture Mount S-5.5	GS0041	152
Guided RP Ratchet Fixture Mount S-5.5, Screw Retained	GS0037	152
Guided Surgery Kit CloseFit UNP/NP Narrow Implants Drills & Tools	GSK002	111
Guided Surgery Kit RS Touareg Implants Tools	GSK003	41, 42
Guided Surgery Kit UniFit Implants Tools	GSK005	73, 74
Guided UniFit Handpiece Fixture Mount S-5.5	GS5041	74
Guided UniFit Ratchet Fixture Mount S-5.5	GS5043	74
Guided UniFit Ratchet Fixture Mount S-5.5, Screw Retained (qty 4)	GS5037	74
Guided UNP Handpiece Fixture Mount S-3.3	GS0018	112
Guided UNP Ratchet Fixture Mount S-3.3	GS0016	112
Guided Vertical Fixation Screw S-3.3 x3 pack	GS0006	113, 153
Guided Vertical Fixation Screw S-5.5 x3 pack	GS0007	43, 75
Guided WP Handpiece Fixture Mount S-5.5	GS0042	152
Guided WP Ratchet Fixture Mount S-5.5, Screw Retained	GS0039	152
Handpiece Guide Fixation Screw Driver	GS0028	42, 74, 112, 152
Handpiece Socket L10.5	GS0021	42, 74, 112, 152
Handpiece Socket L14.5	GS0022	74
Implant packed with :One Piece Torque Driver - Short	RS6025	154
Iris™ Abutment replica	IR0404	17, 86, 124
Iris™ Abutment replica	IR0406	17, 86, 124
Iris™ Abutment replica	IR0408	17, 86, 124
Iris™ NP Abutment	IR0241	86
Iris™ NP Abutment	IR0242	86
Iris™ NP Abutment	IR0243	86
Iris™ NP Abutment	IR0244	86
Iris™ NP CloseFit™ Kit	IR2061	86
Iris™ NP CloseFit™ Kit	IR2062	86
Iris™ NP CloseFit™ Kit	IR2063	86
Iris™ NP CloseFit™ Kit	IR2064	86
Iris™ NP CloseFit™ Kit	IR2081	86
Iris™ NP CloseFit™ Kit	IR2082	86
Iris™ NP Snap-on Impression Kit	IR2141	86
Iris™ NP Snap-on Impression Kit	IR2142	86
Iris™ NP Snap-on Impression Kit	IR2143	86
Iris™ NP Snap-on Impression Kit	IR2144	86
Iris™ NP Snap-on Impression Kit	IR2262	86
Iris™ NP Snap-on Impression Kit	IR2264	86
Iris™ PEEK Comfort cap	IR0180	17, 86, 124
Iris™ PEEK Comfort cap	IR0181	17, 86, 124
Iris™ PEEK Comfort cap	IR0189	17, 86, 124
Iris™ RP Abutment	IR0341	123

Description	Catalog No.	Page No.
Iris™ RP Abutment	IR0342	123
Iris™ RP Abutment	IR0343	123
Iris™ RP Abutment	IR0344	123
Iris™ RP Abutment	IR0361	123
Iris™ RP Abutment	IR0362	123
Iris™ RP Abutment	IR0363	123
Iris™ RP Abutment	IR0364	123
Iris™ RP Abutment	IR0381	123
Iris™ RP Abutment	IR0382	123
Iris™ RP Abutment	IR0383	123
Iris™ RP Abutment	IR0384	123
Iris™ RP CloseFit™ Kit	IR3041	123
Iris™ RP CloseFit™ Kit	IR3042	123
Iris™ RP CloseFit™ Kit	IR3043	123
Iris™ RP CloseFit™ Kit	IR3044	123
Iris™ RP CloseFit™ Kit	IR3061	123
Iris™ RP CloseFit™ Kit	IR3062	123
Iris™ RP CloseFit™ Kit	IR3063	123
Iris™ RP CloseFit™ Kit	IR3064	123
Iris™ RP CloseFit™ Kit	IR3081	123
Iris™ RP CloseFit™ Kit	IR3082	123
Iris™ RP CloseFit™ Kit	IR3083	123
Iris™ RP CloseFit™ Kit	IR3084	123
Iris™ RP Snap-on Impression Kit	IR3141	123
Iris™ RP Snap-on Impression Kit	IR3142	123
Iris™ RP Snap-on Impression Kit	IR3143	123
Iris™ RP Snap-on Impression Kit	IR3144	123
Iris™ RP Snap-on Impression Kit	IR3262	123
Iris™ RP Snap-on Impression Kit	IR3264	123
Iris™ RS Abutment	IR0442	17
Iris™ RS Abutment	IR0443	17
Iris™ RS Abutment	IR0444	17
Iris™ RS Abutment	IR0461	17
Iris™ RS Abutment	IR0462	17
Iris™ RS Abutment	IR0463	17
Iris™ RS Abutment	IR0464	17
Iris™ RS Abutment	IR0481	17
Iris™ RS Abutment	IR0482	17
Iris™ RS Abutment	IR0483	17
Iris™ RS Abutment	IR0484	17
Iris™ RS Kits	IR4041	17
Iris™ RS Kits	IR4042	17
Iris™ RS Kits	IR4043	17
Iris™ RS Kits	IR4044	17
Iris™ RS Kits	IR4061	17
Iris™ RS Kits	IR4062	17
Iris™ RS Kits	IR4063	17
Iris™ RS Kits	IR4064	17
Iris™ RS Kits	IR4081	17

Description	Catalog No.	Page No.
Iris™ RS Kits	IR4082	17
Iris™ RS Kits	IR4083	17
Iris™ RS Kits	IR4084	17
Iris™ UNP Abutment	IR0641	85
Iris™ UNP Abutment	IR0642	85
Iris™ UNP Abutment	IR0643	85
Iris™ UNP Abutment	IR0644	85
Iris™ UNP Abutment	IR0661	85
Iris™ UNP Abutment	IR0662	85
Iris™ UNP Abutment	IR0663	85
Iris™ UNP Abutment	IR0664	85
Iris™ UNP Abutment	IR0681	85
Iris™ UNP Abutment	IR0682	85
Iris™ UNP CloseFit™ Kit	IR6041	85
Iris™ UNP CloseFit™ Kit	IR6042	85
Iris™ UNP CloseFit™ Kit	IR6043	85
Iris™ UNP CloseFit™ Kit	IR6044	85
Iris™ UNP CloseFit™ Kit	IR6061	85
Iris™ UNP CloseFit™ Kit	IR6062	85
Iris™ UNP CloseFit™ Kit	IR6063	85
Iris™ UNP CloseFit™ Kit	IR6064	85
Iris™ UNP CloseFit™ Kit	IR6081	85
Iris™ UNP CloseFit™ Kit	IR6082	85
Iris™ UNP Snap-on Impression Kit	IR6141	85
Iris™ UNP Snap-on Impression Kit	IR6142	85
Iris™ UNP Snap-on Impression Kit	IR6143	85
Iris™ UNP Snap-on Impression Kit	IR6144	85
Iris™ UNP Snap-on Impression Kit	IR6262	85
Iris™ UNP Snap-on Impression Kit	IR6264	85
Iris™ WP Abutment	IR0541	124
Iris™ WP Abutment	IR0542	124
Iris™ WP Abutment	IR0543	124
Iris™ WP Abutment	IR0544	124
Iris™ WP Abutment	IR0561	124
Iris™ WP Abutment	IR0562	124
Iris™ WP Abutment	IR0563	124
Iris™ WP Abutment	IR0564	124
Iris™ WP CloseFit™ Kit	IR5041	124
Iris™ WP CloseFit™ Kit	IR5042	124
Iris™ WP CloseFit™ Kit	IR5043	124
Iris™ WP CloseFit™ Kit	IR5044	124
Iris™ WP CloseFit™ Kit	IR5061	124
Iris™ WP CloseFit™ Kit	IR5062	124
Iris™ WP CloseFit™ Kit	IR5063	124
Iris™ WP CloseFit™ Kit	IR5064	124
Iris™ WP Snap-on Impression Kit	IR5141	124
Iris™ WP Snap-on Impression Kit	IR5142	124
Iris™ WP Snap-on Impression Kit	IR5143	124
Iris™ WP Snap-on Impression Kit	IR5144	124

Description	Catalog No.	Page No.
Iris™ WP Snap-on Impression Kit	IR5262	124
Iris™ WP Snap-on Impression Kit	IR5264	124
Iris™, Burnout anti rotation cap red	IR0182	17, 86, 124
IRIS™, Burnout anti rotation cap red	IR0185	17, 86, 124
IRIS™, Burnout cap white	IR0183	17, 86, 124
IRIS™, Burnout cap white	IR0186	17, 86, 124
IRIS™, Impression coping	IR0179	17, 19, 26, 52, 59, 86, 88, 96, 124, 128, 136
IRIS™, Impression coping	IR0184	17, 86, 124
Manual Socket L10.5	GS0023	42, 74, 112, 152
Metal Housing 4 Pack	RS6413	29, 62, 99, 139
Narrow Implants 3.3mmD Sleeve	GS0033	110, 113, 153
Narrow Tissue Punch 3.0mmD, S-3.3	GSN3033	112
NP 2mm Hex Handpiece Adapter - Medium	NP0071	101, 102, 103, 108, 141, 142, 143
NP 2mm Hex Handpiece Adapter - Short	NP0068	101, 102, 103, 108, 141, 142, 143
NP 2mm Hex Handpiece Adapter 20mm	NP0062	108
NP 2mm Hex Handpiece Adapter 25mm	NP0072	108
NP 2mm Hex Handpiece Adapter 36mm	NP0074	108
NP 2mm Hex Torque Driver 17mm	NP0006	107
NP 2mm Hex Torque Driver 27mm	NP0005	107
NP Abutment Screw	NP0001	87, 92, 93
NP Angled Abutment 15°	NP0015	84
NP Angled Abutment 15°	NP0063	84
NP Angled Abutment 15° No End Line	NP0018	84
NP Angled Single TMA Abutment 17° 3mm	NP0035S	88
NP Angled Single TMA Abutment 17° 3mm	NP0035S	88
NP Angled Single TMA Abutment 17° 4mm	NP0038S	88
NP Angled Single TMA Abutment 17° 4mm	NP0038S	88
NP Angled Single TMA Abutment 30° 3.5mm	NP0036S	88
NP Angled Single TMA Abutment 30° 3.5mm	NP0036S	88
NP Angled Single TMA Abutment 30° 5mm	NP0037S	88
NP Angled Single TMA Abutment 30° 5mm	NP0037S	88
NP Angled Trans Mucosal Abutment 17°	NP0035	95
NP Angled Trans Mucosal Abutment 17°	NP0038	95
NP Angled Trans Mucosal Abutment 17°	NP0035	95
NP Angled Trans Mucosal Abutment 17°	NP0038	95
NP Angled Trans Mucosal Abutment 30°	NP0036	95
NP Angled Trans Mucosal Abutment 30°	NP0037	95
NP Angled Trans Mucosal Abutment 30°	NP0036	95
NP Angled Trans Mucosal Abutment 30°	NP0037	95
NP Ball Attachment	NP0020	97
NP Ball Attachment	NP0021	97
NP Ball Attachment	NP0022	97
NP Ball Attachment	NP0024	97
NP Close Tray Transfer Long	NP5315	82
NP Close Tray Transfer Short	NP5311	82
NP CloseFit™ Slim Healing Abutment	NP0046	81
NP CloseFit™ Slim Healing Abutment	NP0047	81
NP CloseFit™ Slim Healing Abutment	NP0048	81
NP CloseFit™ Slim Healing Abutment	NP0049	81

Description	Catalog No.	Page No.	Description	Catalog No.	Page No.
NP CloseFit™ Slim Healing Abutment	NP0050	81	One™ 3.0D 13L	IO1330	155
NP Conical Healing Abutment	NP0090	81	One™ 3.0D 15L	IO1530	155
NP Conical Healing Abutment	NP0091	81	One™ 3.3D 10L	IO1033	155
NP Conical Healing Abutment	NP0092	81	One™ 3.3D 11.5L	IO1133	155
NP Conical Healing Abutment	NP0093	81	One™ 3.3D 13L	IO1333	155
NP Conical Healing Abutment	NP0094	81	One™ 3.3D 15L	IO1533	155
NP Digital Analog 15(Ncm)	NP1000	83, 93	One™ 3.6D 10L	IO1036	155
NP Engaging Cobalt Chrome/ Plastic Abutment	NP3094	84	One™ 3.6D 11.5L	IO1136	155
NP Engaging Plastic Cylinder Abutment (Casting)	NP0045	84	One™ 3.6D 13L	IO1336	155
NP Engaging Temporary Abutment	NP0043	84	One™ 3.6D 15L	IO1536	155
NP Engaging Titanium/Plastic Abutment (Casting)	NP3095	84	One™ 4.2D 10L	IO1042	155
NP Implant Analog	NP0007	83, 86	One™ 4.2D 11.5L	IO1142	155
NP Non-Engaging Temporary Abutment	NP0044	84	One™ 4.2D 13L	IO1342	155
NP Non-Engaging Titanium/Plastic Abutment (Casting)	NP3097	84	One™ 4.2D 15L	IO1542	155
NP Open Tray Transfer Long	NP5415	82	One™ 5.0D 10L	IO1050	155
NP Open Tray Transfer Screw	NP5014	87	One™ 5.0D 11.5L	IO1150	155
NP Open Tray Transfer Short	NP5411	82	One™ 5.0D 13L	IO1350	155
NP Retaining Screw for TMA 1mm	NP0039	87	One™ 5.0D 15L	IO1550	155
NP Retaining Screw for TMA 2mm	NP0040	87	Open Tray Screw	RS3428	18
NP Retaining Screw for TMA 3mm	NP0041	87	Open Tray Screw	RS3429	18
NP Retaining Screw for TMA 5mm	NP3412	87	Osteotome Handle	HA0074	39, 109, 149
NP Retrieval Screw for Abutments	NP0014	87, 166	Osteotome Insert 2.0mmD HA0061	HA0061	39, 109, 149
NP Scan Body	NP0088	82, 90	Osteotome Insert 2.8mmD	HA0064	39, 109, 149
NP Scan Body	NP0089	82, 91	Osteotome Insert 3.25mmD	HA0067	39, 109, 149
NP Straight Abutment	NP0011	84	Osteotome Insert 3.65mmD	HA0070	39, 109, 149
NP Straight Abutment	NP0019	84	Parallel Pin 16mm	RS6155	31, 32, 37, 64, 65, 69, 101, 102, 109, 141, 142, 149
NP Straight Abutment	NP0064	84	Parallel Pin Short 11mm (qty. 4)	RS6150	31, 32, 37, 64, 65, 69, 101, 102, 109, 141, 142, 149
NP Straight Single TMA Abutment 1mm	NP0032S	88	Pilot Drill 2mmD x 6-13mmL	DL1320	31, 35, 64, 67, 101, 105, 141, 145, 170
NP Straight Single TMA Abutment 2mm	NP0033S	88	Pilot Drill 2mmD x 8-18mmL	DL1820	31, 32, 33, 35, 64, 65, 67, 101, 102, 103, 105, 141, 142, 143, 145, 168
NP Straight Single TMA Abutment 4mm	NP3729S	88	Pilot Drill S-3.3, 2.5/1.8mmDx6.0mmL	GSN062	112
NP Straight Single TMA Abutment 5mm	NP3730S	88	Prosthetic Kit	PK6300	166
NP Straight Slim Abutment No End Line	NP0010	84	Prosthetic Screw	RS3480	18
NP Straight Trans Mucosal Abutment	NP0032	95	Prosthetic Screw For Scan Body 7mm	RS3400	18, 24
NP Straight Trans Mucosal Abutment	NP0033	95	Prosthetic Torque Ratchet 15-35 Ncm	RS6112	38, 70, 106, 146, 166
NP Straight Trans Mucosal Abutment	NP3729	95	Radiographic Template NP CloseFit™	ASD0611	80
NP Straight Trans Mucosal Abutment	NP3730	95	Radiographic Template RP CloseFit™	ASD0612	117, 155
NP Ti Blank	NP1111	90	Radiographic Template Swell™	ASD0613	13
NP Ti Blank	NP1115	90	Radiographic Template Touareg S™	ASD0610	9
NP Wide Healing Abutment	NP0004	81	Radiographic Template Triple™	ASD0616	11
NP Wide Healing Abutment	NP0008	81	Radiographic Template UniFit™	ASD0617	47
NP Wide Healing Abutment	NP0009	81	Radiographic Template UNP CloseFit™	ASD0615	79
NP Wide Healing Abutment	NP0012	81	Retaining Screw	RS1002	12, 15, 49, 57, 83, 93, 121, 133
NP Wide Healing Abutment	NP0013	81	RP 2.25mm Hex Handpiece Adapter - Long	RP0074	101, 102, 103, 141, 142, 143, 148
One™ Analog	RO0030	154	RP 2.25mm Hex Handpiece Adapter - Medium	RP0071	101, 102, 103, 141, 142, 143, 148
One™ Analog	RO0033	154	RP 2.25mm Hex Handpiece Adapter Short 23.7L	RP0068	101, 102, 103, 141, 142, 143, 148
One™ Analog	RO0036	154	RP 2.2mm Hex Torque Driver Short 20.0L	RP0067	147
One™ Analog	RO0042	154	RP 2.2mm Hex Torque Driver-Long 25.0L	RP0066	147
One™ Analog	RO0050	154	RP Abutment Screw	RP0001	125, 132, 133
One™ 3.0D 10L	IO1030	155	RP Angled Titanium Abutment 35	RP0351	121
One™ 3.0D 11.5L	IO1130	155	RP Angled Titanium Abutment 36	RP0352	121

Description	Catalog No.	Page No.	Description	Catalog No.	Page No.
RP Angled Titanium Abutment 37	RP0353	121	RP Scan Body	RP0088	120, 129
RP Ball Attachment	RP0051	137	RP Scan Body	RP0089	120, 130
RP Ball Attachment	RP0052	137	RP Straight Single TMA Abutment 1mm	RP0032S	127
RP Ball Attachment	RP0053	137	RP Straight Single TMA Abutment 2mm	RP0033S	127
RP Ball Attachment	RP0054	137	RP Straight Single TMA Abutment 3mm	RP0034S	127
RP Ball Attachment	RP0055	137	RP Straight Single TMA Abutment 4mm	RP3729S	127
RP Ball Attachment	RP0056	137	RP Straight Slim Abutment No End Line	RP0020	121
RP Close Tray Transfer Long	RP5115	120	RP Straight Trans Mucosal Abutment	RP0032	135
RP Close Tray Transfer Short	RP5111	120	RP Straight Trans Mucosal Abutment	RP0033	135
RP Closed Tray Transfer Screw - Long	RP5127	125	RP Straight Trans Mucosal Abutment	RP0034	135
RP Closed Tray Transfer Screw - Short	RP5126	125	RP Straight Trans Mucosal Abutment	RP3729	135
RP CloseFit™ Conical Cover Screw	RP0073	119	RP Ti Blank	RP1211	129
RP CloseFit™ Conical Healing Abutment	RP0090	119	RP Ti Blank	RP1215	129
RP CloseFit™ Conical Healing Abutment	RP0091	119	RS 2.4 Hex Torque Driver 27mm	RS6012	37, 162, 163
RP CloseFit™ Conical Healing Abutment	RP0092	119	RS 2.4mm Hex Torque Driver - Short	RS6011	37, 162, 163
RP CloseFit™ Conical Healing Abutment	RP0093	119	RS Angled Single TMA 17° 3mm	RS3737S	19
RP CloseFit™ Conical Healing Abutment	RP0094	119	RS Angled Single TMA 30° 3mm	RS3735S	19
RP CloseFit™ Healing Abutment	RP0022	119	RS Angled Single TMA 30° 4mm	RS3738S	19
RP CloseFit™ Healing Abutment	RP0023	119	RS Angled Titanium Abutment 35°	RS4035	16
RP CloseFit™ Healing Abutment	RP0024	119	RS Angled Titanium Abutments 15°	RS4015	16
RP CloseFit™ Healing Abutment	RP0025	119	RS Angled Titanium Abutments 15°	RS4016	16
RP CloseFit™ Healing Abutment	RP0026	119	RS Angled TMA 17° 3mm	RS3737	25, 164
RP CloseFit™ Slim Healing Abutment	RP0046	119	RS Angled TMA 30° 3mm	RS3735	25, 164
RP CloseFit™ Slim Healing Abutment	RP0047	119	RS Angled TMA 30° 4mm	RS3738	25, 164
RP CloseFit™ Slim Healing Abutment	RP0048	119	RS Angled TMA 52° 4mm	RS3739	25, 164
RP CloseFit™ Slim Healing Abutment	RP0049	119	RS Angled TMA 60° 4mm	RS3740	25, 164
RP CloseFit™ Slim Healing Abutment	RP0050	119	RS Angled Trans Mucosal Abutment Gauge 17°	RS3741	26, 165
RP Digital Analog 15(Ncm)	RP1000	121, 133	RS Angled Trans Mucosal Abutment Gauge 30°	RS3742	26, 165
RP Engaging Plastic Cylinder Abutment (Casting)	RP0045	122	RS Angled Trans Mucosal Abutment Gauge 45°	RS3743	26, 165
RP Engaging Temporary Abutment	RP0043	121	RS Angled Trans Mucosal Abutment Gauge 45°	RS3744	26, 165
RP Esthetic Angled Abutment 15°	RP0013	121	RS Angled Trans Mucosal Abutment Gauge 60°	RS3745	26, 165
RP Esthetic Angled Abutment 15°	RP0014	121	RS Angled Trans Mucosal Abutment Gauge Kit	RS3747	26, 165
RP Esthetic Angled Abutment 15°	RP0015	121	RS Ball Attachment	RS2650	27
RP Esthetic Straight Abutment	RP0010	121	RS Ball Attachment	RS2651	27
RP Handpiece Hex Adapter - Long 25.0L	RP0072	148	RS Ball Attachment	RS2652	27
RP Handpiece Hex Adapter - Short 20.0L	RP0062	148	RS Ball Attachment	RS2653	27
RP Implant Analog	RP0007	121	RS Ball Attachment	RS2654	27
RP Non-Engaging Cobalt Chrome/ Plastic Abutment	RP3100	123	RS Ball Attachment	RS2655	27
RP Non-Engaging Temporary Abutment	RP0044	121	RS Ball Attachment w/Hex	RS2861	27
RP Open Tray Transfer Long	RP5617	120	RS Ball Attachment w/Hex	RS2862	27
RP Open Tray Transfer Screw - Long	RP5014	125	RS Ball Attachment w/Hex	RS2863	27
RP Open Tray Transfer Screw - Short	RP5010	125	RS Ball Attachment w/Hex	RS2864	27
RP Open Tray Transfer Short	RP5613	120	RS Ball Attachment w/Hex	RS2865	27
RP Ratchet retrieval tool	GS0046	152	RS Ball Attachment w/Hex	RS2866	27
RP Retaining Screw for Angled TMA	RP3403	125	RS Close Tray Transfer Long	RS5115	15
RP Retaining Screw for TMA 1mm	RP0039	125	RS Close Tray Transfer Short	RS5111	15
RP Retaining Screw for TMA 2mm	RP0040	125	RS Cover Screw	RS3435	14
RP Retaining Screw for TMA 3mm	RP0041	125	RS Digital Model Analog	RS1000	15, 24
RP Retaining Screw for TMA 5mm	RP3412	125	RS Engaging Gold/Plastic Abutment	RS3090	18
RP Retrieval Screw for Abutments	RP3401	125	RS Engaging Plastic Casting Standard Abutment	RS5010	18

Description	Catalog No.	Page No.	Description	Catalog No.	Page No.
RS Engaging Plastic Cylinder Abutment	RS5040	18	RS Straight Single TMA 3mm	RS3733S	19
RS Engaging Plastic Cylinder Casting Abutment	RS5000	18	RS Straight Single TMA 4mm	RS3729S	19
RS Engaging Plastic Standard Abutment	RS5030	18	RS Straight Titanium Abutment - No End Line	RS3800	16
RS Engaging Titanium/Plastic Abutment	RS3095	18	RS Straight TMA 1mm	RS3731	25, 164
RS Esthetic Angled Titanium Abutments 15°	RS4115	16	RS Straight TMA 2mm 2.0	RS3732	25, 164
RS Esthetic Straight Abutments	RS0010	16	RS Straight TMA 3mm	RS3733	25, 164
RS Esthetic Straight Abutments	RS0011	16	RS Straight TMA 4mm	RS3729	25, 164
RS Esthetic Straight Abutments	RS0012	16	RS Titanium Abutment 5.0 mmD Wide	RS3950	16
RS Extraction Tool	GS0035	42	RS Titanium Straight Abutments	RS3801	16
RS Grip Fixture Mount	GS0034	42	RS Titanium Straight Abutments	RS3802	16
RS Guided Surgery Advanced Kit	RS6322	32	RS Titanium Straight Abutments	RS3803	16
RS Guided Surgery Premium Kit	RS6301	31	RS Titanium Straight Abutments	RS3804	16
RS Handpiece Fixture Mount	GS0032	42	RS Titanium Straight Abutments	RS3805	16
RS Healing Abutment	RS3022	14	RS Wide Healing Abutment	RS3012	14
RS Healing Abutment	RS3023	14	RS Wide Healing Abutment	RS3013	14
RS Healing Abutment	RS3024	14	RS Wide Healing Abutment	RS3014	14
RS Healing Abutment	RS3025	14	RS Wide Healing Abutment	RS3015	14
RS Healing Abutment	RS3026	14	RS Wide Healing Abutment	RS3016	14
RS Healing Abutment	RS3042	14	RS Wide Healing Abutment	RS3017	14
RS Hex Handpiece Adapter- Long	RS9029	31, 32, 33, 37, 162, 163	Screw for Closed Tray Transfer For Scan Body 10mm	RS3425	24
RS Hex Handpiece Adapter- Medium	RS9026	31, 32, 33, 37	Short Prosthetic Screw For Ti Bases & Ti Balnks	RS3402	18, 24
RS Non-Engaging Cobalt Chrome/ Plastic Abutment	RS3100	18	Single TMA Abutment Replica	RS5004S	19
RS Non-Engaging Plastic Standard Abutment	RS5050	18	Single TMA Digital Model Replica	RS1001S	19, 52, 88, 128,
RS Non-Engaging Straight Cylindrical Titanium Abutment	RS3422	16	Single TMA Healing Cup	RS5005S	20, 25, 53, 89, 128
RS Open Tray Transfer Long	RS3517	15	Single TMA Impression Coping Open Tray	RS5006S	20, 25, 53, 89, 128
RS Open Tray Transfer Short	RS3513	15	Single TMA Plastic Casting Sleeve w/Prosthetic Screw	RS5001S	20, 53, 89, 128
RS Retaining Screw for Angled TMA	RS3403	165	Single TMA Titanium Temporary	RS4900	20, 24, 26, 57, 59, 94, 96, 134, 136, 165
RS Retaining Screw for TMA 1mm	RS3406	165	Stainless Steel Ball Cap	RS2675SS	97, 137
RS Retaining Screw for TMA 2mm	RS3407	165	Star Hand Driver Long	RP0004	20, 26, 39, 53, 57, 59, 62, 64, 65, 71, 74, 94, 99, 101, 102, 103, 107, 112, 134, 139, 141, 142, 143, 147, 152, 165, 166
RS Retaining Screw for TMA 3mm	RS3408	165	Star Hand Driver Short	RP0064	20, 26, 39, 53, 57, 59, 62, 64, 65, 71, 74, 94, 99, 101, 102, 103, 107, 112, 134, 139, 141, 142, 143, 147, 152, 165, 166
RS Retaining Screw for TMA 4mm	RS3409	165	Star Handpiece Drive 30mm	RP0019	71, 108, 148, 166
RS Retaining Screw for TMA 5mm	RS3412	165	Star Handpiece Driver - Short 25.0L	RP0018	71, 108, 148, 166
RS Retrieval Screw For Abutments 15mm	RS3401	39, 166	Star torque Driver - Long	RP0005	20, 26, 38, 59, 70, 107, 147, 162, 163, 165, 166
RS Scan Body	RS0088	15, 21	Star Torque Driver-Short	RP0065	20, 26, 38, 59, 70, 107, 147, 162, 163, 165, 166
RS Scan Body	RS0089	15, 21	Surgical Driver	RS7001	36, 68, 106, 146, 156, 162
RS Screw	RS3405	23	Surgical Torque Ratchet 35-100 Ncm	RS6111	31, 32, 36, 64, 65, 68, 101, 102, 106, 141, 142, 146
RS Slim Angled Abutments 15° - No End Line	RS4017	16	Surgical Torque Ratchet 35-100 Ncm for hex 4mm	GS6111	42, 74, 112, 152
RS Slim Angled Abutments 15° - No End Line	RS4018	16	Swell™ 3.3D 10L	ID1033	13
RS Slim Angled Abutments 15° - No End Line	RS4019	16	Swell™ 3.3D 13L	ID1333	13
RS Slim Healing Abutment	RS3027	14	Swell™ 3.3D 16L	ID1633	13
RS Slim Healing Abutment	RS3028	14	Swell™ 3.3D 18L	ID1833	13
RS Slim Healing Abutment	RS3029	14	Swell™ 3.75D 10L	ID1038	13
RS Slim Healing Abutment	RS3030	14	Swell™ 3.75D 13L	ID1338	13
RS Slim Healing Abutment	RS3031	14	Swell™ 3.75D 16L	ID1638	13
RS Slim Healing Abutment	RS3040	14	Swell™ 3.75D 18L	ID1838	13
RS Slim Titanium Abutments	RS3903	16	Swell™ 3.75D 8L	ID0838	13
RS Slim Titanium Abutments	RS3906	16	Swell™ 4.2D 10L	ID1042	13
RS Slim Titanium Abutments	RS3908	16			
RS Straight Single TMA 1mm	RS3731S	19			
RS Straight Single TMA 2mm	RS3732S	19			

Description	Catalog No.	Page No.
Swell™ 4.2D 13L	ID1342	13
Swell™ 4.2D 16L	ID1642	13
Swell™ 4.2D 18L	ID1842	13
Swell™ 4.2D 6.25L	ID0642	13
Swell™ 4.2D 8L	ID0842	13
Swell™ 5.0D 10L	ID1050	13
Swell™ 5.0D 11.5L	ID1150	13
Swell™ 5.0D 13L	ID1350	13
Swell™ 5.0D 16L	ID1650	13
Swell™ 5.0D 6.25L	ID0650	13
Swell™ 6.0D 10L	ID1060	13
Swell™ 6.0D 11.5L	ID1160	13
Swell™ 6.0D 13L	ID1360	13
Swell™ 6.0D 8L	ID0860	13
Ti Base RS Abutment, RH 4mm GH 4mm Engaged	TB04441	21
Ti Base RS Abutment, RH 4mm GH 4mm Engaged	TB04442	21
Ti Base RS Abutment, RH 4mm GH 4mm Engaged Wide	TB04441W	21
Ti Base RS Abutment, RH 4mm GH 4mm Non Engaged Wide	TB04442W	22
Ti Base WP Abutment, RH 4mm GH 1mm Angular Engaged	TB05413	132
Ti Base WP Abutment, RH 4mm GH 1mm Angular Engaged Wide	TB05413W	132
Ti Base WP Abutment, RH 4mm GH 2mm Angular Engaged	TB05423	132
Ti Base WP Abutment, RH 4mm GH 2mm Angular Engaged Wide	TB05423W	132
Ti Base WP Abutment, RH 4mm GH 3mm Angular Engaged	TB05433	132
Ti Base WP Abutment, RH 4mm GH 3mm Angular Engaged Wide	TB05433W	132
Ti Base WP Abutment, RH 6mm GH 1mm Angular Engaged	TB05613	132
Ti Base WP Abutment, RH 6mm GH 1mm Angular Engaged Wide	TB05613W	132
Ti Base WP Abutment, RH 6mm GH 2mm Angular Engaged	TB05623	132
Ti Base WP Abutment, RH 6mm GH 2mm Angular Engaged Wide	TB05623W	132
Ti Base WP Abutment, RH 6mm GH 3mm Angular Engaged	TB05633	132
Ti Base WP Abutment, RH 6mm GH 3mm Angular Engaged Wide	TB05633W	132
Ti Base WP Abutment, RH 8mm GH 1mm Angular Engaged	TB05813	132
Ti Base WP Abutment, RH 8mm GH 1mm Angular Engaged Wide	TB05813W	132
Ti Base WP Abutment, RH 8mm GH 2mm Angular Engaged	TB05823	132
Ti Base WP Abutment, RH 8mm GH 2mm Angular Engaged Wide	TB05823W	132
Ti Base WP Abutment, RH 8mm GH 3mm Angular Engaged	TB05833	132
Ti Base WP Abutment, RH 8mm GH 3mm Angular Engaged Wide	TB05833W	132
Ti Blank	RS1411	21
Ti Blank	RS1415	21
Tip Drill	RS8032	31, 64, 65, 101, 141
Titanium Ball Cap	RS2670	27, 60, 97, 137
TMA Digital Model Replica	RS1001	24, 25, 58, 98, 136, 164
TMA Healing Cup	RS5003	164
TMA Healing Cup	RS5005	58, 95, 136, 164
TMA Hex Torque Driver - Long	RS6196	20, 26, 38, 59, 70, 107, 148, 165, 166
TMA Impression Coping Open Tray	RS5006	58, 95, 136, 164
TMA Plastic Casting Sleeve/Prosthetic Screw	RS5001	165, 26, 59, 96, 136
TMA Prosthetic Screw 15(Ncm)	RS3404	20, 24, 26, 53, 57, 59, 87, 93, 96, 125, 126, 133, 136, 165
TMA Screw for Closed Tray Transfer	RS5009	165
TMA Screw for Open Tray Transfer	RS5008	165

Description	Catalog No.	Page No.
TMA Titanium Temporary	RS4900S	24, 53, 57, 59, 89, 94, 128, 134
TMA/FC Female Hand Hex Driver 22.4mm	RS6193	20, 26, 39, 59, 71, 107, 147, 165, 166
TMA/FC Female Hand Hex Driver-Long	RS6191	20, 26, 39, 59, 71, 107, 147, 165, 166
TMA/FC Hex Handpiece Adapter-Long	RS6195A	20, 26, 39, 59, 71, 107, 147, 165, 166
TMA/FC Hex Handpiece Adapter-Short	RS6194	20, 26, 39, 59, 71, 107, 147, 165, 166
TMA/FC Hex Torque Driver 20mm	RS6197	20, 26, 38, 59, 70, 107, 147, 165, 166
Torque Driver for Ball Attachment 14.4m	RS6090	27, 38, 60, 70, 107, 148, 166
Touareg™-OS 3.5D 10L	ISF1035	9
Touareg™-OS 3.5D 11.5L	ISF1135	9
Touareg™-OS 3.5D 13L	ISF1335	9
Touareg™-OS 3.5D 16L	ISF1635	9
Touareg™-OS 3.5D 18L	ISF1835	9
Touareg™-OS 3.5D 8L	ISF0835	9
Touareg™-OS 3.75D 10L	ISF1038	9
Touareg™-OS 3.75D 11.5L	ISF1138	9
Touareg™-OS 3.75D 13L	ISF1338	9
Touareg™-OS 3.75D 16L	ISF1638	9
Touareg™-OS 3.75D 18L	ISF1838	9
Touareg™-OS 3.75D 8L	ISF0838	9
Touareg™-OS 4.2D 10L	ISF1042	9
Touareg™-OS 4.2D 11.5L	ISF1142	9
Touareg™-OS 4.2D 13L	ISF1342	9
Touareg™-OS 4.2D 16L	ISF1642	9
Touareg™-OS 4.2D 18L	ISF1842	9
Touareg™-OS 4.2D 6.25L	ISF0642	9
Touareg™-OS 4.2D 8L	ISF0842	9
Touareg™-OS 5.0D 10L	ISF1050	9
Touareg™-OS 5.0D 11.5L	ISF1150	9
Touareg™-OS 5.0D 13L	ISF1350	9
Touareg™-OS 5.0D 16L	ISF1650	9
Touareg™-OS 5.0D 6.25L	ISF0650	9
Touareg™-OS 5.0D 8L	ISF0850	9
Touareg™-OS 6.0D 10L	ISF1060	9
Touareg™-OS 6.0D 11.5L	ISF1160	9
Touareg™-OS 6.0D 13L	ISF1360	9
Touareg™-OS 6.0D 6.25L	ISF0660	9
Touareg™-OS 6.0D 8L	ISF0860	9
Touareg™-OS Long Implant 4.25D 20L	ISF2042	157
Touareg™-OS Long Implant 4.25D 22.50L	ISF2242	157
Touareg™-OS Long Implant 4.25D 25L	ISF2542	157
Touareg™-S 3.5D 10L	ISPS1035	9
Touareg™-S 3.5D 11.5L	ISPS1135	9
Touareg™-S 3.5D 13L	ISPS1335	9
Touareg™-S 3.5D 16L	ISPS1635	9
Touareg™-S 3.5D 18L	ISPS1835	9
Touareg™-S 3.5D 8L	ISPS0835	9
Touareg™-S 3.75D 10L	ISPS1038	9
Touareg™-S 3.75D 11.5L	ISPS1138	9
Touareg™-S 3.75D 13L	ISPS1338	9

Description	Catalog No.	Page No.
Touareg™-S 3.75D 16L	ISPS1638	9
Touareg™-S 3.75D 18L	ISPS1838	9
Touareg™-S 3.75D 8L	ISPS0838	9
Touareg™-S 4.2D 10L	ISPS1042	9
Touareg™-S 4.2D 11.5L	ISPS1142	9
Touareg™-S 4.2D 13L	ISPS1342	9
Touareg™-S 4.2D 16L	ISPS1642	9
Touareg™-S 4.2D 18L	ISPS1842	9
Touareg™-S 4.2D 6.25L	ISPS0642	9
Touareg™-S 4.2D 8L	ISPS0842	9
Touareg™-S 5D 10L	ISPS1050	9
Touareg™-S 5D 11.5L	ISPS1150	9
Touareg™-S 5D 13L	ISPS1350	9
Touareg™-S 5D 16L	ISPS1650	9
Touareg™-S 5D 6.25L	ISPS0650	9
Touareg™-S 5D 8L	ISPS0850	9
Touareg™-S 6D 10L	ISPS1060	9
Touareg™-S 6D 11.5L	ISPS1160	9
Touareg™-S 6D 13L	ISPS1360	9
Touareg™-S 6D 6.25L	ISPS0660	9
Touareg™-S 6D 8L	ISPS0860	9
Triple 3.5D 10L	IST1035	11
Triple 3.5D 11L	IST1135	11
Triple 3.5D 13L	IST1335	11
Triple 3.5D 16L	IST1635	11
Triple 3.5D 18L	IST1835	11
Triple 3.5D 8L	IST0835	11
Triple 3.8D 10L	IST1038	11
Triple 3.8D 11L	IST1138	11
Triple 3.8D 13L	IST1338	11
Triple 3.8D 16L	IST1638	11
Triple 3.8D 18L	IST1838	11
Triple 3.8D 8L	IST0838	11
Triple 4.2D 16L	IST1642	11
Triple 4.2D 18L	IST1842	11
Triple 4.2D 6L	IST0642	11
Triple 4.2D 8L	IST0842	11
Triple 5.0D 10L	IST1050	11
Triple 5.0D 13L	IST1350	11
Triple 5.0D 16L	IST1650	11
Triple 5.0D 6L	IST0650	11
Triple 6.0D 10L	IST1060	11
Triple 6.0D 13L	IST1360	11
Triple 6.0D 8L	IST0860	11
Twist Step Drill 1.8/2.5mmD x 6-13mmL	DL1325	35, 67, 101, 105, 141, 145
Twist Step Drill 1.8/2.5mmD x 8-18mmL	DL1825	35, 67, 101, 105, 141, 145
Twist Step Drill 2.3/2.8mmD x 8-18mmL	DL1828	31, 32, 33, 35, 64, 65, 67, 101, 102, 103, 105, 141, 142, 143, 145, 168
Twist Step Drill 2.3/2.8mmDx6-13mmL	DL1328	31, 35, 64, 67, 101, 105, 141, 145, 170
Twist Step Drill 2.8/3.2mmD x8-18mmL	DL1832	31, 32, 33, 35, 64, 65, 67, 101, 102, 103, 105, 141, 142, 143, 145, 168

Description	Catalog No.	Page No.
Twist Step Drill 2.8/3.2mmDx6-13mmL	DL1332	31, 35, 64, 67, 101, 105, 141, 145, 170
Twist Step Drill 3.2/3.6mmD x8-18mmL	DL1836	31, 32, 33, 35, 64, 65, 67, 101, 102, 103, 105, 141, 142, 143, 145, 168
Twist Step Drill 3.2/3.6mmDx6-13mmL	DL1336	31, 35, 64, 67, 101, 105, 141, 145, 170
Twist Step Drill 3.8/4.2mmD x 8-18mmL	DL1842	31, 32, 33, 35, 64, 65, 67, 101, 102, 103, 105, 141, 142, 143, 145, 168
Twist Step Drill 3.8/4.2mmDx6-13mmL	DL1342	31, 35, 64, 67, 101, 105, 141, 145, 171
Twist Step Drill 3.9mmDx6-13mmL	DL1339	35, 67, 105, 145
Twist Step Drill 3.9mmDx6-18mmL	DL1839	35, 67, 105, 145
Twist Step Drill 4.2/4.6mmD x 8-18mmL	DL1846	141, 142, 145, 169, 31, 32, 33, 35, 64, 65, 67, 101, 102, 105
Twist Step Drill 4.2/4.6mmDx6-13mmL	DL1346	31, 35, 64, 67, 101, 105, 141, 145, 171
Twist Step Drill 4.8/5.2mmD x 6-13mmL	DL1352	31, 35, 64, 67, 105, 145, 171
Twist Step Drill 5.2/5.6mmDx6-13mmL	DL1356	31, 35, 64, 67, 105, 145, 171
UniFit 3.5D 10L	ISPUF1035	47
UniFit 3.5D 13L	ISPUF1335	47
UniFit 3.5D 16L	ISPUF1635	47
UniFit 3.5D 18L	ISPUF1835	47
UniFit 3.5D 8L	ISPUF0835	47
UniFit 3.75D 10L	ISPUF1038	47
UniFit 3.75D 13L	ISPUF1338	47
UniFit 3.75D 16L	ISPUF1638	47
UniFit 3.75D 18L	ISPUF1838	47
UniFit 4.3D 10L	ISPUF1043	47
UniFit 4.3D 13L	ISPUF1343	47
UniFit 4.3D 16L	ISPUF1643	47
UniFit 4.3D 18L	ISPUF1843	47
UniFit 4.3D 6L	ISPUF0643	47
UniFit 4.3D 8L	ISPUF0843	47
UniFit 5.0D 10L	ISPUF1049	47
UniFit 5.0D 13L	ISPUF1349	47
UniFit 5.0D 16L	ISPUF1649	47
UniFit 5.0D 18L	ISPUF1849	47
UniFit 5.0D 6L	ISPUF0649	47
UniFit 5.0D 8L	ISPUF0849	47
UniFit 6.0D 10L	ISPUF1060	47
UniFit 6.0D 13L	ISPUF1360	47
UniFit 6.0D 6L	ISPUF0660	47
UniFit 6.0D 8L	ISPUF0860	47
UniFit Abutment Screw M1.6	UF0001	56, 57
UniFit Angled Abutment 15° 1mm	UF0013	51
UniFit Angled Abutment 15° 2mm	UF0014	51
UniFit Angled Abutment 15° 3mm	UF0015	51
UniFit Angled Abutment 25° 1.5mm	UF2515	51
UniFit Angled Abutment 25° 3mm	UF2530	51
UniFit Angled Abutment Wide 15° 1mm	UF0013W	51
UniFit Angled Abutment Wide 15° 2mm	UF0014W	51
UniFit Angled Abutment Wide 15° 3mm	UF0015W	51
UniFit Angled Abutment Wide 25° 1.5mm	UF2515W	51
UniFit Angled Abutment Wide 25° 3mm	UF2530W	51
UniFit Angled Abutment Wide 35° 1.5mm	UF3515W	51
UniFit Angled Abutment Wide 35° 3mm	UF3530W	51

Description	Catalog No.	Page No.
UniFit Angled Single TMA 17° 2.5mm	UF3734S	52
UniFit Angled Single TMA 17° 3.5mm	UF3737S	52
UniFit Angled Single TMA 30° 3mm	UF3735S	52
UniFit Angled Single TMA 30° 4mm	UF3738S	52
UniFit Angled Trans Mucosal Abutment 17° 1.5mm	UF3732	58
UniFit Angled Trans Mucosal Abutment 17° 2.5mm	UF3734	58
UniFit Angled Trans Mucosal Abutment 17° 3.5mm	UF3737	58
UniFit Angled Trans Mucosal Abutment 17° 4.5mm	UF3739	58
UniFit Angled Trans Mucosal Abutment 30° 1mm	UF3726	58
UniFit Angled Trans Mucosal Abutment 30° 2mm	UF3727	58
UniFit Angled Trans Mucosal Abutment 30° 3mm	UF3735	58
UniFit Angled Trans Mucosal Abutment 30° 4mm	UF3738	58
UniFit Ball Attachment 0.5mm	UF0051	60
UniFit Ball Attachment 1mm	UF0052	60
UniFit Ball Attachment 2mm	UF0053	60
UniFit Ball Attachment 3mm	UF0054	60
UniFit Ball Attachment 4mm	UF0055	60
UniFit Ball Attachment 5mm	UF0056	60
UniFit Conical Healing Abutment 4.5mmD x 2mmL	UF0090	48
UniFit Conical Healing Abutment 4.5mmD x 3mmL	UF0091	48
UniFit Conical Healing Abutment 4.5mmD x 4mmL	UF0092	48
UniFit Conical Healing Abutment 4.5mmD x 5mmL	UF0093	48
UniFit Conical Healing Abutment 4.5mmD x 6mmL	UF0094	48
UniFit Conical Healing Abutment Slim 3.5mmD x 2mmL	UF0095	48
UniFit Conical Healing Abutment Slim 3.5mmD x 3mmL	UF0096	48
UniFit Conical Healing Abutment Slim 3.5mmD x 4mmL	UF0097	48
UniFit Conical Healing Abutment Slim 3.5mmD x 5mmL	UF0098	48
UniFit Conical Healing Abutment Slim 3.5mmD x 6mmL	UF0099	48
UniFit Conical Healing Abutment Wide 5.5mmD x 2mmL	UF0095W	48
UniFit Conical Healing Abutment Wide 5.5mmD x 3mmL	UF0096W	48
UniFit Conical Healing Abutment Wide 5.5mmD x 4mmL	UF0097W	48
UniFit Conical Healing Abutment Wide 5.5mmD x 5mmL	UF0098W	48
UniFit Conical Healing Abutment Slim 3.5mmD x 6mmL	UF0099	48
UniFit Conical Healing Abutment Wide 5.5mmD x 2mmL	UF0095W	48
UniFit Conical Healing Abutment Wide 5.5mmD x 3mmL	UF0096W	48
UniFit Conical Healing Abutment Wide 5.5mmD x 4mmL	UF0097W	48
UniFit Conical Healing Abutment Wide 5.5mmD x 5mmL	UF0098W	48
UniFit Conical Healing Abutment Wide 5.5mmD x 6mmL	UF0099W	48
UniFit Conical Implant Cover Screw	UF0073	48
UniFit Digital Model Analog	UF1000	49,57
UniFit Engaging Temporary Abutment Slim 3.5mmD	UF0036	50
UniFit Engaging Temporary Abutment Wide 5.5mmD	UF0043W	50
UniFit Engaging Titanium/Plastic Abutment	UF3095	51
UniFit Engaging Titanium/Plastic Abutment Wide	UF3095W	51
UniFit Healing Abutment 4.5mmD x 2mmL	UF0022	48
UniFit Healing Abutment 4.5mmD x 3mmL	UF0023	48
UniFit Healing Abutment 4.5mmD x 5mmL	UF0025	48
UniFit Healing Abutment 4.5mmD x 6mmL	UF0026	48
UniFit Healing Abutment Slim 3.5mmD x 2mmL	UF0046	48

Description	Catalog No.	Page No.
UniFit Healing Abutment Slim 3.5mmD x 3mmL	UF0047	48
UniFit Healing Abutment Slim 3.5mmD x 4mmL	UF0048	48
UniFit Healing Abutment Slim 3.5mmD x 5mmL	UF0049	48
UniFit Healing Abutment Slim 3.5mmD x 6mmL	UF0050	48
UniFit Healing Abutment Wide 5.5mmD x 2mmL	UF0046W	48
UniFit Healing Abutment Wide 5.5mmD x 3mmL	UF0047W	48
UniFit Healing Abutment Wide 5.5mmD x 4mmL	UF0048W	48
UniFit Healing Abutment Wide 5.5mmD x 5mmL	UF0049W	48
UniFit Healing Abutment Wide 5.5mmD x 6mmL	UF0050W	48
UniFit Implant Analog	UF0007	49, 57
UniFit Non-Engaging Cobalt Chrome/Plastic Abutment	UF3100	51
UniFit Non-Engaging Cobalt Chrome/Plastic Abutment Wide	UF3100W	51
UniFit Non-Engaging Temporary Abutment Slim 3.5mmD	UF0037	50
UniFit Non-Engaging Temporary Abutment Wide 5.5mmD	UF0044W	50
UniFit Plastic Cylinder Abutment Slim 3.5mmD	UF0038	51
UniFit Ratchet Retrieval Tool	GS5046	74
UniFit Ratchet Retrieval Tool for Abutments	UF3401	64,65,71
UniFit Scan Body 10mm	UF0089	49,54
UniFit Scan Body 7mm	UF0088	49,54
UniFit Star Handpiece Adapter - Long	UF0074	65,66,69
UniFit Star Handpiece Adapter - Medium	UF0071	65,66,69
UniFit Star Handpiece Adapter - Short	UF0068	65,66,69
UniFit Star Torque Driver-Long	UF0066	65,66,69
UniFit Star Torque Driver-Short	UF0067	65,66,69
UniFit Straight Abutment	UF0011	50
UniFit Straight Abutment	UF0012	50
UniFit Straight Abutment 3mm	UF0010	50
UniFit Straight Abutment Wide	UF0011W	50
UniFit Straight Abutment Wide	UF0012W	50
UniFit Straight Abutment Wide 3mm	UF0010W	50
UniFit Straight Single TMA 1mm	UF0032S	52
UniFit Straight Single TMA 2mm	UF0033S	52
UniFit Straight Single TMA 3mm	UF0034S	52
UniFit Straight Single TMA 4mm	UF3729S	52
UniFit Straight Single TMA 5mm	UF3730S	52
UniFit Straight Trans Mucosal Abutment 1mm	UF0032	58
UniFit Straight Trans Mucosal Abutment 2mm	UF0033	58
UniFit Straight Trans Mucosal Abutment 3mm	UF0034	58
UniFit Straight Trans Mucosal Abutment 4mm	UF3729	58
UniFit Straight Trans Mucosal Abutment 5mm	UF3730	58
UniFit3.75D 8L	ISPUF0838	47
UniFit-Standard Internal Star Plastic Surgical Kit-Advanced	UF6322	65
UniFit-Standard Internal Star Plastic Surgical Kit-Premium1	UF6301	64
UNP 2mm Hex Handpiece Adapter - Long	UNP0074	108
UNP 2mm Hex Handpiece Adapter - Medium	UNP0071	108
UNP 2mm Hex Handpiece Adapter - Short	UNP0068	108
UNP CloseFit™ Abutment Insertion Tool	UNP1001	107
UNP CloseFit™ Abutment Screw	UNP0001	87,92,93
UNP CloseFit™ Angled Abutment 15° - No End Line	UNP0018	83

Description	Catalog No.	Page No.
UNP CloseFit™ Angled Abutment 15° 1mm	UNP0063	83
UNP CloseFit™ Angled Abutment 15° 2mm	UNP0015	83
UNP CloseFit™ Angled Abutment 15° 3mm	UNP0026	83
UNP CloseFit™ Ball Attachment 0.5mm	UNP0020	97
UNP CloseFit™ Ball Attachment 1mm	UNP0021	97
UNP CloseFit™ Ball Attachment 2mm	UNP0022	97
UNP CloseFit™ Ball Attachment 3mm	UNP0023	97
UNP CloseFit™ Ball Attachment 4mm	UNP0024	97
UNP CloseFit™ Ball Attachment 5mm	UNP0025	97
UNP CloseFit™ Close Tray Transfer Long	UNP5715	82
UNP CloseFit™ Close Tray Transfer Screw	UNP5127	87
UNP CloseFit™ Close Tray Transfer Short	UNP5711	82
UNP CloseFit™ Conical Cover Screw	UNP0073	81
UNP CloseFit™ Conical Healing Abutment 4mmDX2mmL	UNP0090	81
UNP CloseFit™ Conical Healing Abutment 4mmDX3mmL	UNP0091	81
UNP CloseFit™ Conical Healing Abutment 4mmDX4mmL	UNP0092	81
UNP CloseFit™ Conical Healing Abutment 4mmDX5mmL	UNP0093	81
UNP CloseFit™ Conical Healing Abutment 4mmDX6mmL	UNP0094	81
UNP CloseFit™ Engaging Temporary Abutment	UNP0043	83
UNP CloseFit™ Healing Abutment 4mmDX2mmL	UNP0004	81
UNP CloseFit™ Healing Abutment 4mmDX3mmL	UNP0008	81
UNP CloseFit™ Healing Abutment 4mmDX4mmL	UNP0009	81
UNP CloseFit™ Healing Abutment 4mmDX5mmL	UNP0012	81
UNP CloseFit™ Healing Abutment 4mmDX6mmL	UNP0013	81
UNP CloseFit™ Non Engaging Temporary Abutment	UNP0044	83
UNP CloseFit™ One Piece Screw-In Abutment 1mm	UNP3812	83
UNP CloseFit™ One Piece Screw-In Abutment 2mm	UNP3813	83
UNP CloseFit™ Open Tray Transfer Long	UNP5617	82
UNP CloseFit™ Open Tray Transfer Screw	UNP5014	87
UNP CloseFit™ Open Tray Transfer Short	UNP5613	82
UNP CloseFit™ Plastic Cylinder Abutment	UNP0045	83
UNP CloseFit™ Scan Body 10mm	UNP0089	82,90
UNP CloseFit™ Scan Body 7mm	UNP0088	82,90
UNP CloseFit™ Slim Healing Abutment 2.75mmDX2mmL	UNP0046	81
UNP CloseFit™ Slim Healing Abutment 2.75mmDX3mmL	UNP0047	81
UNP CloseFit™ Slim Healing Abutment 2.75mmDX4mmL	UNP0048	81
UNP CloseFit™ Slim Healing Abutment 2.75mmDX5mmL	UNP0049	81
UNP CloseFit™ Slim Healing Abutment 2.75mmDX6mmL	UNP0050	81
UNP CloseFit™ Straight Abutment 1mm	UNP0019	83
UNP CloseFit™ Straight Abutment 2mm	UNP0011	83
UNP CloseFit™ Straight Abutment 3mm	UNP0064	83
UNP CloseFit™ Straight Slim Abutment - No End Line	UNP0010	83
UNP CloseFit™ Ti Pre Milled MDTK Abutment Blank ø11.5mm	UNP1711	90
UNP CloseFit™ Ti Pre Milled MDTK Abutment Blank ø15.8mm	UNP1715	90
UNP Digital Model Analog	UNP1000	83,93
UNP Engaging Cobalt Chrome/Plastic Abutment	UNP3094	84
UNP Implant Analog	UNP0007	83,86
UNP Non-Engaging Cobalt Chrome/Plastic Abutment	UNP3100	84
WP 2.65mm Hex Handpiece Adapter - Long	WP0074	101, 102, 103, 141, 142, 143
WP 2.65mm Hex Handpiece Adapter - Medium	WP0071	101, 102, 103, 141, 142, 143

Description	Catalog No.	Page No.
WP 2.65mm Hex Handpiece Adapter - Short	WP0068	101, 102, 103, 141, 142, 143
WP 2.6mm Torque Driver-Long	WP0066	147
WP 2.6mm Torque Driver-Short	WP0067	147
WP Abutment Screw	WP0001	126,132,133
WP Angled Abutment 15° 1mm	WP0013	122
WP Angled Abutment 15° 2mm	WP0014	122
WP Angled Abutment 15° 3mm	WP0015	122
WP Angled Single TMA 17° 3.5mm	WP3737S	127
WP Angled Single TMA 30° 3mm	WP3735S	127
WP Angled Single TMA 30° 4mm	WP3738S	127
WP Angled Titanium Abutment 25°, GH 1mm	WP0251	122
WP Angled Titanium Abutment 25°, GH 2mm	WP0252	122
WP Angled Titanium Abutment 25°, GH 3mm	WP0253	122
WP Angled Titanium Abutment 35°, GH 1mm	WP0351	122
WP Angled Titanium Abutment 35°, GH 2mm	WP0352	122
WP Angled Titanium Abutment 35°, GH 3mm	WP0353	122
WP Angled Trans Mucosal Abutment 17° 2.5mm	WP3734	135
WP Angled Trans Mucosal Abutment 17° 3.5mm	WP3737	135
WP Angled Trans Mucosal Abutment 30° 3mm	WP3735	135
WP Angled Trans Mucosal Abutment 30° 4mm	WP3738	135
WP Angled Trans Mucosal Abutment 52° 5mm	WP3739	136
WP Angled Trans Mucosal Abutment 60° 5mm	WP3740	136
WP Ball Attachment 0.5mm	WP0051	137
WP Ball Attachment 1mm	WP0052	137
WP Ball Attachment 2mm	WP0053	137
WP Ball Attachment 3mm	WP0054	137
WP Ball Attachment 4mm	WP0055	137
WP Ball Attachment 5mm	WP0056	137
WP CloseFit™ Close Tray Transfer Long	WP5115	120
WP CloseFit™ Close Tray Transfer Screw Long	WP5127	126
WP CloseFit™ Close Tray Transfer Screw Short	WP5126	126
WP CloseFit™ Close Tray Transfer Short	WP5111	120
WP CloseFit™ Open Tray Transfer Long	WP5617	120
WP CloseFit™ Open Tray Transfer Screw	WP5014	126
WP CloseFit™ Open Tray Transfer Screw Short	WP5010	126
WP CloseFit™ Open Tray Transfer Short	WP5613	120
WP CloseFit™ Scan Body 10mm	WP0089	120,129
WP CloseFit™ Scan Body 7mm	WP0088	120,129
WP CloseFit™ Ti Pre Milled MDTK Abutment Blank ø11.5mm	WP1311	129
WP CloseFit™ Ti Pre Milled MDTK Abutment Blank ø15.8mm	WP1315	129
WP Conical Healing Abutment 5.5mmD x 2mmL	WP0090	119
WP Conical Healing Abutment 5.5mmD x 3mmL	WP0091	119
WP Conical Healing Abutment 5.5mmD x 4mmL	WP0092	119
WP Conical Healing Abutment 5.5mmD x 5mmL	WP0093	119
WP Conical Healing Abutment 5.5mmD x 6mmL	WP0094	119
WP Conical Implant Cover Screw	WP0073	119
WP Digital Model Analog	WP1000	121,133
WP Engaging Temporary Abutment	WP0043	122
WP Engaging Titanium/Plastic Abutment	WP3095	122
WP Healing Abutment 5.5mmD x 2mmL	WP0022	119

Description	Catalog No.	Page No.
WP Healing Abutment 5.5mmD x 4mmL	WP0024	119
WP Healing Abutment 5.5mmD x 5mmL	WP0025	119
WP Healing Abutment 5.5mmD x 6mmL	WP0026	119
WP Implant Analog	WP0007	121,124
WP Non-Engaging Temporary Abutment	WP0044	122
WP Non-Engaging Titanium/Plastic Abutment	WP3097	122
WP Plastic Cylinder Abutment	WP0045	122
WP Ratchet retrieval tool	GS0047	152
WP Retaining Screw for Angled TMA	WP3403	126
WP Retaining Screw for TMA 1mm	WP3406	126
WP Retaining Screw for TMA 2mm	WP3407	126
WP Retaining Screw for TMA 3mm	WP3408	126
WP Retaining Screw for TMA 4mm	WP3409	126
WP Retaining Screw for TMA 5mm	WP3412	126
WP Retrieval Screw for Abutments	WP3401	126
WP Slim Healing Abutment 4mmD x 2mmL	WP0046	119
WP Slim Healing Abutment 4mmD x 3mmL	WP0047	119
WP Slim Healing Abutment 4mmD x 4mmL	WP0048	119
WP Slim Healing Abutment 4mmD x 6mmL	WP0050	119
WP Straight Abutment 1mm	WP0012	122
WP Straight Abutment 2mm	WP0011	122
WP Straight Abutment 3mm	WP0010	122
WP Straight Single TMA 1mm	WP3731S	127
WP Straight Single TMA 2mm	WP3732S	127
WP Straight Single TMA 3mm	WP3733S	127
WP Straight Single TMA 4mm	WP3729S	127

Description	Catalog No.	Page No.
WP Straight Single TMA 5mm	WP3730S	127
WP Straight Slim Abutment-No End Line	WP0020	122
WP Straight Trans Mucosal Abutment 1mm	WP3731	135
WP Straight Trans Mucosal Abutment 2mm	WP3732	135
WP Straight Trans Mucosal Abutment 3mm	WP3733	135
WP Straight Trans Mucosal Abutment 4mm	WP3729	135
WP Straight Trans Mucosal Abutment 5mm	WP3730	135
Wrench Ratchet	RS6100	33, 36, 68, 103, 106, 143, 146, 162, 163
Wrench Ratchet Surgical Instruments Handle	RA0050	31, 32, 33, 37, 64, 65, 67, 101, 102, 103, 107, 141, 142, 143, 148, 162, 163
Zygomatic Diamond Burr 4.2mmDx35mmL, Coarse	ZGDB3542C	162
Zygomatic Diamond Burr 4.2mmDx35mmL, Medium	ZGDB3542M	162
Zygomatic implants 4.2D 35L	ISZT3542	159
Zygomatic implants 4.2D 37.5L	ISZT3742	159
Zygomatic implants 4.2D 40L	ISZT4042	159
Zygomatic implants 4.2D 42.5L	ISZT4242	159
Zygomatic implants 4.2D 45L	ISZT4542	159
Zygomatic implants 4.2D 47.5L	ISZT4742	159
Zygomatic implants 4.2D 50L	ISZT5042	159
Zygomatic implants 4.2D 52.5L	ISZT5242	159
Zygomatic implants 4.2D 55L	ISZT5542	159
Zygomatic Mark Drill 2.4mmD	DL5524	161, 163
Zygomatic pilot Drill 1.8/2.5mmD x 35-55mmL DL5525	DL5525	161, 163
Zygomatic surgical Kit, Standard Hex	ZGSK001	162
Zygomatic Twist Step Drill 2.8/3.2mmD x 35-55mmL DL5532	DL5532	161, 163
Zygomatic Twist Step Drill 3.2/3.6mmD x 35-55mmL	DL5536	161, 163

* Illustrations are not to scale

* The product images displayed in this catalog are illustrative and intended as a guide. The final product may have variations.

* Availability of the products in some places is limited and depends on local regulations.

* For more information, please contact your local representative.



Industrial Park Allon Tavor, POB 1128, Afula 1811101, Israel
+972-4-6426732 | www.adin-implants.com