



CloseFit™ Narrow

Small Enough to Fit,
Strong Enough to Last.

Product Catalog



CloseFit™

Narrow Implants

When you're seeking to minimize micro-movements between the dental implant and the abutment and to reduce potential bone loss, you'll benefit from Adin's CloseFit™ spiral implant system, which features an extremely strong, stable and solid conical-hex connection.

The CloseFit's tapered core implant includes a multi-lead active & dynamic thread design. The unique design of the implant is suited for optimal repositioning at diverse angles within the lower and upper jaw. Designed for subcrestal placement up to 1.0 - 2.0mm.

The CloseFit™ implants feature Adin's OsseoFix™ - A biocompatible surface treatment that uses gritting with Calcium Phosphate media that is debris free and has been designed to achieve the desired roughness levels needed for optimal osseointegration.

With more than 10 years of proven clinical experience, these uniquely designed small diameter implants of 2.75mm & 3.0mm, have an especially narrow body & collar to provide a perfect solution that addresses narrow ridges in atrophic jaws for exceptional aesthetic results.

The strong Conical Connection is designed to minimize micro movements.

UNP CloseFit™

Ø 2.75mmD
Ultra Narrow Platform

Optimally designed for narrow ridges, minimize the need for bone augmentation

OsseoFix™ Surface

Triple lead thread with 3.0mm (3x1mm)
For fast efficient insertion

NP CloseFit™

Ø 3.0mmD
Narrow Platform

* Platform Switching

* Micro Threads:
Engineered to enhance bone regeneration, prevent bone loss & increase bone implant contact

Double lead threads
2.4mm (2x1.2mm)
For fast efficient insertion

* Length

L-10mm | L-11.5mm | L-13 mm
L-16mm | L-18 mm

*The features related to UNP & NP Implants

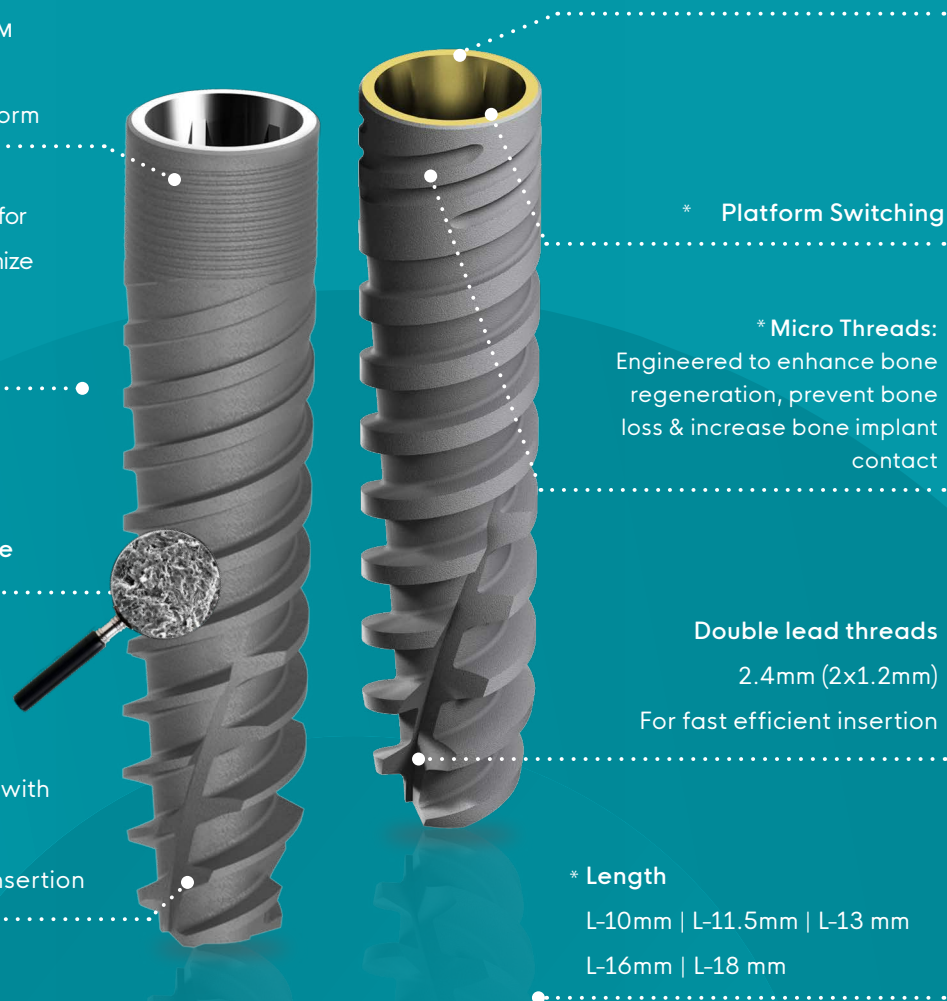

Ultra Narrow Platform

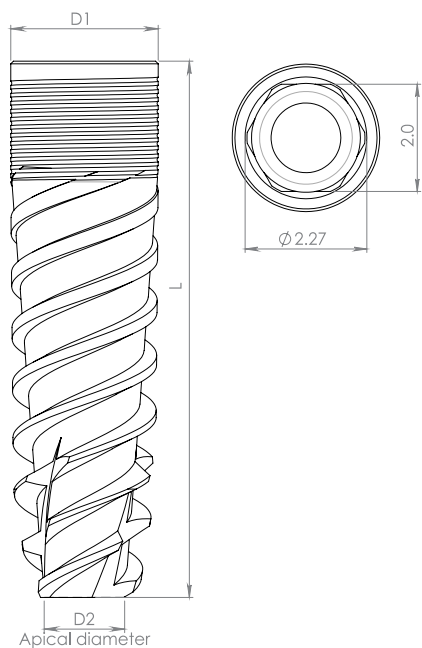

Recommended insertion torque up to 50 Ncm

	D1	L	D2	Catalog No.
	2.75	10.0	1.5	ISPUNP1027
		11.5	1.5	ISPUNP1127
		13.0	1.5	ISPUNP1327
		16.0	1.5	ISPUNP1627
		18.0	1.5	ISPUNP1827

Radiographic Template UNP CloseFit™ | ASD0615

Drill Sequence for UNP Recommended drilling speed up to 1200 rpm

Implant Diameter $\phi 2.75$

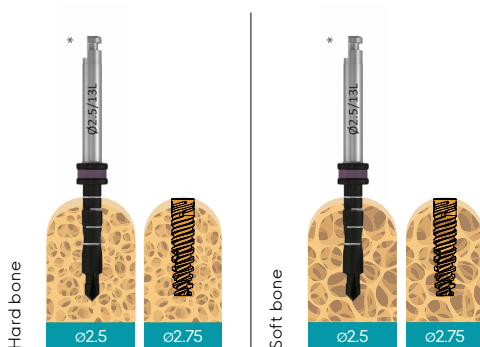

All measurements are in mm

*Products may be ordered separately as an addition to the kit

Note: (x.xx) Drill to the depth of the cortex only. All measurements are in mm.

⚠ CAUTION: The drill preparation is up to 1mm longer than the implant.

* The drill apical step = 1.8mmD.

Narrow Platform

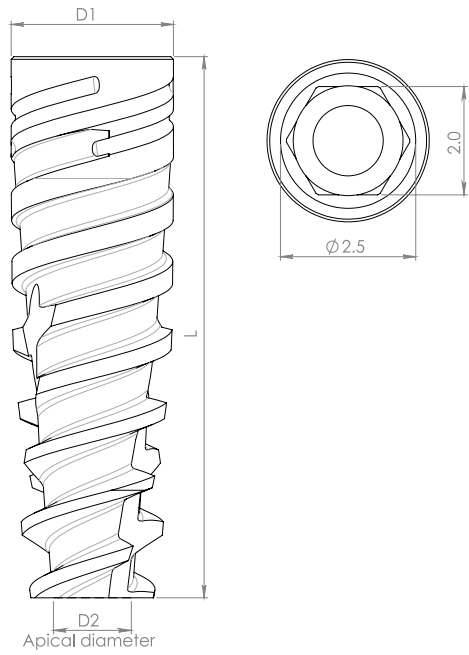

Recommended insertion torque up to 50 Ncm

	3.0	10.0	1.5	ISPNP1030
		11.5	1.5	ISPNP1130
		13.0	1.5	ISPNP1330
		16.0	1.5	ISPNP1630
		18.0	1.5	ISPNP1830

Radiographic Template NP CloseFit™ | ASD0611

Drill Sequence for NP Recommended drilling speed up to 1200 rpm

Implant Diameter $\varnothing 3.0$

$\varnothing 3.0$

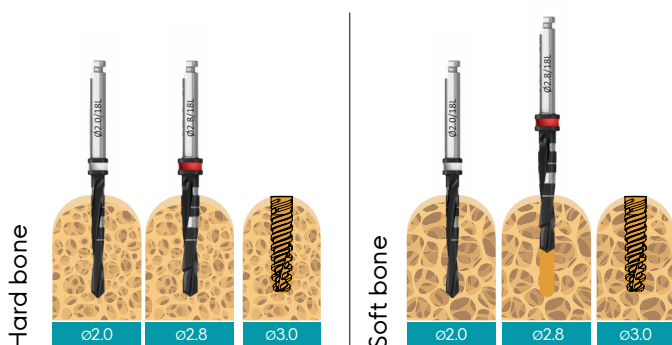

All measurements are in mm.

Note: (x.xx) Drill to the depth of the cortex only.





⚠ CAUTION: The drill preparation is up to 1mm longer than the implant. * The drill apical step = 1.8mmD.

Cover Screw & Healing Abutments

Recommended Torque 15(Ncm)

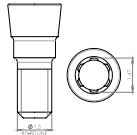

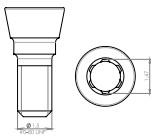
Cover Screw Packed with implant

		Description	Catalog No.
		UNP CloseFit™ Conical Cover Screw	UNP0073
		NP CloseFit™ Conical Cover Screw	NP0073

Healing Abutments

		Description	∅	GH	Catalog No.
		UNP CloseFit™ Slim Healing Abutment	2.75	2.0	UNP0046
			2.75	3.0	UNP0047
			2.75	4.0	UNP0048
			2.75	5.0	UNP0049
			2.75	6.0	UNP0050
		UNP CloseFit™ Healing Abutment	4.0	2.0	UNP0004
			4.0	3.0	UNP0008
			4.0	4.0	UNP0009
			4.0	5.0	UNP0012
			4.0	6.0	UNP0013
		UNP CloseFit™ Conical Healing Abutment	4.0	2.0	UNP0090
			4.0	3.0	UNP0091
			4.0	4.0	UNP0092
			4.0	5.0	UNP0093
			4.0	6.0	UNP0094
		NP CloseFit™ Slim Healing Abutment	3.0	2.0	NP0046
			3.0	3.0	NP0047
			3.0	4.0	NP0048
			3.0	5.0	NP0049
			3.0	6.0	NP0050
		NP Wide Healing Abutment	4.5	2.0	NP0004
			4.5	3.0	NP0008
			4.5	4.0	NP0009
			4.5	5.0	NP0012
			4.5	6.0	NP0013
		NP Conical Healing Abutment	4.5	2.0	NP0090
			4.5	3.0	NP0091
			4.5	4.0	NP0092
			4.5	5.0	NP0093
			4.5	6.0	NP0094

Impression Recommended Torque 15(Ncm)

Our components for taking impressions for all restoration types can be successfully utilized for digital or conventional protocols either implant-level or abutment level procedures.

Our broad range of solutions and flexible designs enable easy and accurate restorative planning, whether you're dealing with a single tooth, multiple teeth, bridge or full mouth rehabilitation.



UNP Transfers | Recommended Torque 15(Ncm)

	Open Tray	Description	L	D1	H	Catalog No.		Close Tray	Description	L	D1	H	Catalog No.
		UNP Open Tray Transfer Short	20.0	6.0	12.0	UNP5613			UNP Close Tray Transfer Short	11.0	3.2	9.0	UNP5711
		UNP Open Tray Transfer Long	23.5	6.0	15.0	UNP5617			UNP Close Tray Transfer Long	15.0	3.2	13.0	UNP5715

NP Transfers | Recommended Torque 15(Ncm)

	Open Tray	Description	L	D1	H	Catalog No.		Close Tray	Description	L	D1	H	Catalog No.
		NP Open Tray Transfer Short	20.0	6.0	12.0	NP5411			NP Close Tray Transfer Short	10.7	3.5	9.0	NP5311
		NP Open Tray Transfer Long	23.4	6.0	15.0	NP5415			NP Close Tray Transfer Long	15.0	3.5	13.0	NP5315

UNP Scan Bodies

	Description	H	Catalog No.		Description	H	Catalog No.
	UNP Scan Body	7	UNP0088		UNP Scan Body	10	UNP0089

NP Scan Bodies

	Description	H	Catalog No.		Description	H	Catalog No.
	NP Scan Body	7	NP0088		NP Scan Body	10	NP0089

	Description	L	D1	Catalog No.		Description	Catalog No.		Description	L	D1	Catalog No.
	UNP Digital Analog 15(Ncm)	10.0	3.55	UNP1000		Retaining Screw	RS1002		UNP Implant Analog	12.6	3.6	UNP0007

NP Analogs

	Description	L	D1	Catalog No.		Description	Catalog No.		Description	L	D1	Catalog No.
	NP Digital Analog 15(Ncm)	10.0	3.55	NP1000		Retaining Screw	RS1002		NP Implant Analog	12.6	3.6	NP0007

Temporary & Cement Retained Restoration

Recommended Torque 35(Ncm)

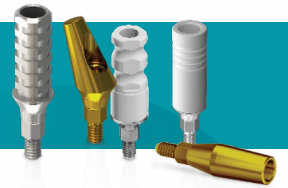

	Description	D1	GH	RH	Catalog No.
	UNP Non Engaging Temporary Abutment	3.70	2.00	8.00	UNP0044
	UNP Engaging Temporary Abutment	3.70	2.00	8.00	UNP0043
	UNP Straight Slim Abutment No End Line	3.50	1.00	7.30	UNP0010
	UNP Straight Abutment	4.20	1.00	6.50	UNP0019
		4.20	2.00	6.50	UNP0011
		4.20	3.00	6.50	UNP0064
	UNP Angled Abutment 15° No End Line	3.50	1.00	6.10	UNP0018
	UNP Angled Abutment 15°	4.20	1.00	6.50	UNP0063
		4.20	2.00	6.50	UNP0015
		4.20	3.00	6.50	UNP0026
	UNP One Piece Screw in Abutment	3.50	1.10	9.30	UNP3812
		3.50	2.00	9.30	UNP3813
		3.50	3.00	9.30	UNP3814
	UNP Engaging Plastic Cylinder Abutment	3.70	2.00	8.00	UNP0045

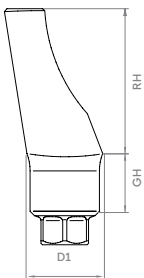

		Description	D1	GH	RH	Catalog No.
		UNP Engaging Cobalt Chrome/ Plastic Abutment	3.70	2.00	8.00	UNP3094
		UNP Non-Engaging Cobalt Chrome/ Plastic Abutment	3.70	2.00	8.00	UNP3100

NP Abutments

		Description	D1	GH	RH	Catalog No.
		NP Engaging Temporary Abutment	3.7	0.7	8.0	NP0043
		NP Non-Engaging Temporary Abutment	3.7	0.7	8.0	NP0044
		NP Straight Slim Abutment No End Line	3.5	3.2	5.7	NP0010
		NP Straight Abutment	4.4	1.0	6.5	NP0019
			4.4	2.0	6.5	NP0011
			4.4	3.0	6.5	NP0064
		NP Angled Abutment 15° No End Line	4.3	1.4	8.2	NP0018
		NP Angled Abutment 15°	4.8	1.0	6.5	NP0015
			4.8	2.0	6.5	NP0026
			4.8	3.0	6.5	NP0063
		NP Angled Abutment 25° No End Line	3.8	1.6	6.5	NP0025
		NP Engaging Plastic Cylinder Abutment (Casting)	3.7	0.7	8.0	NP0045
		NP Engaging Cobalt Chrome/ Plastic Abutment	4.2	1.0	10.0	NP3094
		NP Engaging Titanium/ Plastic Abutment (Casting)	4.2	1.0	10.0	NP3095
		NP Non-Engaging Titanium / Plastic Abutment (Casting)	4.2	1.0	10.0	NP3097

Iris™ Snap - on for UNP and NP

Adin's Snap-on impression is an effective and easy option for both implant level and abutment level impression copying. Plastic pickup cap placed over a precision machined abutment allows for accurate coping utilizing closed tray impression. Adin's Snap-on range aims to allow flexibility by offering various options to match users preferred method of use through pre packed kits:

- IRIS™ Kit - abutment level impression and restoration set
- Snap-on impression kit - implant level impression



UNP Iris™ Kit



Description	RH	GH	Catalog No.
Iris™ UNP CloseFit™ Kit	4	1	IR6041
		2	IR6042
		3	IR6043
		4	IR6044
	6	1	IR6061
		2	IR6062
		3	IR6061
		4	IR6062
	8	1	IR6063
		2	IR6064
		3	IR6081
		4	IR6082

UNP Snap-on Impression Kit



Description	RH	GH	Catalog No.
Iris™ UNP Snap-on Impression Kit	4	1	IR6141
		2	IR6142
		3	IR6143
		4	IR6144
	6	2	IR6262
		4	IR6264



Description	RH	GH	Catalog No.
Iris™ UNP Abutment	4	1	IR0641
		2	IR0642
		3	IR0643
		4	IR0644
	6	1	IR0661
		2	IR0662
		3	IR0663
		4	IR0664
	8	1	IR0681
		2	IR0682

NP Iris™ Kit



Iris™ NP CloseFit™ Kit	4	1	IR2041
		2	IR2042
		3	IR2043
		4	IR2044
	6	1	IR2061
		2	IR2062
		3	IR2063
		4	IR2064
	8	1	IR2081
		2	IR2082

NP Snap-on Impression Kit







Description	RH	GH	Catalog No.
Iris™ NP Snap-on Impression Kit	4	1	IR2141
		2	IR2142
		3	IR2143
		4	IR2144
	6	2	IR2262
		4	IR2264



NP Snap-on Impression Pack



Description	RH	GH	Catalog No.
Iris™ NP Abutment	4	1	IR0241
		2	IR0242
		3	IR0243
		4	IR0244
	6	1	IR0261
		2	IR0262
		3	IR0263
		4	IR0264
	8	1	IR0281
		2	IR0282

Purchase Options

	Description	RH	Catalog No.
	UNP Implant Analog	-	UNP0007
	NP Implant Analog	-	NP0007
	Iris™ Abutment replica	4	IR0404
		6	IR0406
		8	IR0408
	Iris™ PEEK Comfort cap	4	IR0180
		6	IR0181
		8	IR0189



	Description	Qty	Catalog No.
	Iris™, Burnout anti rotation cap red	1	IR0182
		4	IR0185
	Iris™, Burnout cap white	4	IR0183
		6	IR0186
	Iris™, Impression coping	1	IR0179
		4	IR0184

Narrow Screw - Retained











Recommended Torque 35(Ncm)



UNP Screws

	Description	L	Ø	Catalog No.
	UNP Abutment Screw	7.90	2.00	UNP0001
	UNP Closed Tray Transfer Screw	20.00	2.80	UNP5127
	UNP Open Tray Transfer Screw	28.00	3.10	UNP5014

NP Screws

	Description	L	Ø	Catalog No.
	NP Abutment Screw	7.9	2.0	NP0001
	TMA Prosthetic Screw 15(Ncm)	4.1	2.1	RS3404
	NP Retaining Screw for Angled TMA	7.1	2.0	NP0042
	NP Retaining Screw for TMA 1mm	8.0	3.1	NP0039
	NP Retaining Screw for TMA 2mm	9.0	3.1	NP0040
	NP Retaining Screw for TMA 3mm	10.0	3.1	NP0041
	NP Retaining Screw for TMA 4mm	11.0	3.1	NP3409
	NP Retaining Screw for TMA 5mm	12.0	3.1	NP3412
	NP Open Tray Transfer Screw	28.0	3.1	NP5014
	NP Closed Tray Transfer Screw	20.0	2.8	NP5127
	NP Retrieval Screw for Abutments	13.4	2.0	NP0014

NP Single TMA™ Recommended Torque 35(Ncm)

Adding to Adin's variety of the screw-retained restoration range, in comes the single TMA. Utilizing all the benefits of the TMA abutments while allowing the accuracy and flexibility for single tooth restoration.

Adin's STMA offers the possibility to combine the benefits of trans-gingival approach and screw-retained single tooth restoration yielding greater flexibility in both esthetics, safety and restoration maintenance. Adin's Single TMA is based on the TMA abutment, while the added hex index offers both the required accurate positioning and retention to support a single tooth crown. Open and closed tray transfers as well as scan bodies for digital impression are available to match every preferred impression method as well as replicas for straight forward and simple work process.

		Description	GH	Catalog No.
		NP Straight Single TMA Abutment 1mm	1.0	NP0032S
		NP Straight Single TMA Abutment 2mm	2.0	NP0033S
		NP Straight Single TMA Abutment 3mm	3.0	NP0034S
		NP Straight Single TMA Abutment 4mm	4.0	NP3729S
		NP Straight Single TMA Abutment 5mm	5.0	NP3730S
		NP Angled Single TMA Abutment 17° 3mm	2.8	NP0035S
		NP Angled Single TMA Abutment 17° 4mm	3.9	NP0038S
		NP Angled Single TMA Abutment 30° 3.5mm	3.4	NP0036S
		NP Angled Single TMA Abutment 30° 5mm	4.9	NP0037S

Transfers

	Description	L	D1	D2	Catalog No.		Description	L	D1	D2	Catalog No.
	Single TMA Impression Coping Open Tray	11.0	4.9	3.1	RS5006S		Single TMA Closed Tray Transfer	8.0	4.9	4.1	RS5011S

Snap-On

	Description	L	D1	D2	Catalog No.		Description	Catalog No.
	Single TMA Snap-On Transfer	8.0	4.9	3.2	RS5012S		IRIS™, Impression coping	IR0179





Analogs

	Description	L	D1	Catalog No.		Description	L	D1	D2	Catalog No.
	Single TMA Abutment Replica	16.8	3.35	RS5004S		Single TMA Digital Model Replica	12.0	4.9	3.8	RS1001S

Scan Bodies

	Description	L	D1	Catalog No.
	Single TMA Scan Body	6.0	4.9	TM0006S
		9.0	4.9	TM0009S

STMA Prosthetics

	Description	L	D1	D2	H	Catalog No.
	Single TMA Titanium Temporary	12.0	4.9	3.5	10.5	RS4900S
	Single TMA Plastic Casting Sleeve w/Prosthetic Screw	12.0	4.9	3.3	10.5	RS5001S
	Single TMA Healing Cup	5.5	4.9	3.5	-	RS5005S
	Single TMA Cementing Cone, low profile	4.9	5.5	3.2	-	TM0011S





CAD CAM

Adin's CAD - CAM components and digital libraries enable clinicians and technicians to design and manufacture state-of-the-art restorations supported by Adin's implants, using current digital restoration processes.



The variety of components ensures endless restorative options for treatment of single, multiple, partially, or fully edentulous cases.







UNP

For Intra-oral and Desktop Scanner		H	Catalog No.	For Medentika PreFace® Holder		Ø	Catalog No.
	UNP Scan Body	7	UNP0088		UNP Ti Blank	11.5	UNP1711
		10	UNP0089			15.8	UNP1715



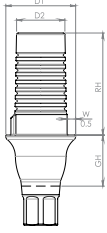

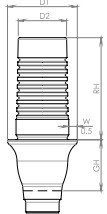
NP

For Intra-oral and Desktop Scanner		H	Catalog No.	For Medentika PreFace® Holder		Ø	Catalog No.
	UNP Scan Body	7	NP0088		NP Ti Blank	11.5	NP1111
		10	NP0089			15.8	NP1115



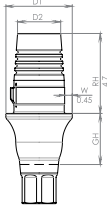

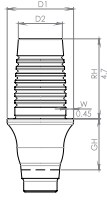
UNP Ti Base Abutments

	Description	RH	GH	D1	D2	Catalog No.
	 Ti Base UNP Abutment, Engaged	4.0	1.5	4.1	2.9	TB06411
		4.0	2.0	4.1	2.9	TB06421
		4.0	3.0	4.1	2.9	TB06431
		4.0	4.0	4.1	2.9	TB06441
		6.0	1.5	4.1	2.8	TB06611
		6.0	2.0	4.1	2.8	TB06621
		6.0	3.0	4.1	2.8	TB06631
		6.0	4.0	4.1	2.9	TB06641
		8.0	1.5	4.1	2.8	TB06811
		8.0	2.0	4.1	2.8	TB06821
	 Ti Base UNP Abutment, Non Engaged	4.0	1.5	4.1	2.9	TB06412
		4.0	2.0	4.1	2.9	TB06422
		4.0	3.0	4.1	2.9	TB06432
		4.0	4.0	4.1	2.9	TB06442
		6.0	1.5	4.1	2.8	TB06612
		6.0	2.0	4.1	2.8	TB06622
		6.0	3.0	4.1	2.8	TB06632
		6.0	4.0	4.1	2.8	TB06642
		8.0	1.5	4.1	2.8	TB06812
		8.0	2.0	4.1	2.8	TB06822

For further product information and use please refer to IFU028

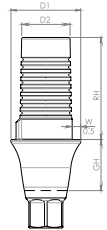

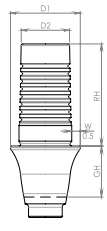

	Description	RH	GH	D1	D2	Catalog No.
	 C-Type Ti Base UNP Abutment, Engaged	4.7	1.5	3.9	2.5	TB06414
		4.7	2.0	3.9	2.5	TB06424
		4.7	3.0	3.9	2.5	TB06434
		4.7	4.0	3.9	2.5	TB06444
	 C-Type Ti Base UNP Abutment, Non Engaged	4.7	1.5	3.9	2.6	TB06415
		4.7	2.0	3.9	2.6	TB06425
		4.7	3.0	3.9	2.6	TB06435
		4.7	4.0	3.9	2.6	TB06445

NP Ti Base Abutments

	Description	RH	GH	D1	D2	Catalog No.
	 Ti Base NP Abutment,	4.0	1.5	4.1	2.9	TB02411
		4.0	2.0	4.1	2.9	TB02421
		4.0	3.0	4.1	2.9	TB02431
		4.0	4.0	4.1	2.9	TB02441
		6.0	1.5	4.1	2.8	TB02611
		6.0	2.0	4.1	2.8	TB02621
		6.0	3.0	4.1	2.8	TB02631
		6.0	4.0	4.1	2.8	TB02641
		8.0	1.5	4.1	2.8	TB02811
		8.0	2.0	4.1	2.8	TB02821
	 Ti Base NP Abutment,	4.0	1.5	4.1	2.9	TB02412
		4.0	2.0	4.1	2.9	TB02422
		4.0	3.0	4.1	2.9	TB02432
		4.0	4.0	4.1	2.9	TB02442
		6.0	1.5	4.1	2.8	TB02612
		6.0	2.0	4.1	2.8	TB02622
		6.0	3.0	4.1	2.8	TB02632
		6.0	4.0	4.1	2.8	TB02642
		8.0	1.5	4.1	2.8	TB02812
		8.0	2.0	4.1	2.8	TB02822

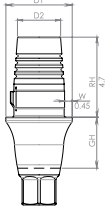
NP C-Type Ti Base Abutments

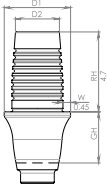
For further product information and use please refer to IFU028

	Description	RH	GH	D1	D2	Catalog No.
	 C-Type Ti Base NP Abutment, Engaged	4.7	1.5	3.9	2.5	TB02414
		4.7	2.0	3.9	2.5	TB02424
		4.7	3.0	3.9	2.5	TB02434
		4.7	4.0	3.9	2.5	TB02444
	 C-Type Ti Base NP Abutment, Non Engaged	4.7	1.5	3.9	2.6	TB02415
		4.7	2.0	3.9	2.6	TB02425
		4.7	3.0	3.9	2.6	TB02435
		4.7	4.0	3.9	2.6	TB02445

CAD CAM | Angulated Screw Channel

The angulated screw channel (ASC) solution offers a transformative approach to dental restorations. ASC strategically places a screw access hole at an angle within the prosthesis, optimizing both function and esthetics.

By integrating digital planning and specialized drivers, ASC enhances accuracy and predictability in implant-supported restorations. This approach signifies a significant advancement in dental care, prioritizing esthetics and functionality to ensure patient satisfaction.

Adin's angulated screw channel Ti bases support gingival heights of 1-3mm for every each implant platform and allow for angulation of up to 20 degrees.

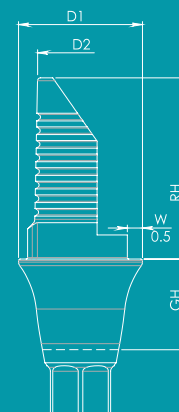

Ti Base Abutment Angular



	RH	GH	D1	D2	Catalog No.		RH	GH	D1	D2	Catalog No.
 UNP Ti Base Abutment Angular Engaged	4.0	1.5	4.1	2.9	TB06413	 NP Ti Base Abutment Angular Engaged	4.0	1.5	4.1	2.9	TB02413
	4.0	2.0	4.1	2.9	TB06423		4.0	2.0	4.1	2.9	TB02423
	4.0	3.0	4.1	2.9	TB06433		4.0	3.0	4.1	2.9	TB02433
	6.0	1.5	4.1	2.9	TB06613		6.0	1.5	4.1	2.8	TB02613
	6.0	2.0	4.1	2.9	TB06623		6.0	2.0	4.1	2.8	TB02623
	6.0	3.0	4.1	2.9	TB06633		6.0	3.0	4.1	2.8	TB02633
	8.0	1.5	4.1	2.9	TB06813		8.0	1.5	4.1	2.8	TB02813
	8.0	2.0	4.1	2.9	TB06823		8.0	2.0	4.1	2.8	TB02823
	Abutments are supplied with UNP0001 screw. Recommended torque 25Ncm. Also available separately				UNP0001		Abutments are supplied with NP0001 screw. Recommended torque 25Ncm. Also available separately				NP0001

Angulated Tools



	Angulated Screw Extractor Hand Driver	24.7	10	1.4	9.4	RP6400
	Angulated Star Screw Hand Driver - Short 23.4L	23.4	9.0	1.4	9.4	RP6401
	Angulated Star Screw Hand Driver - Long 28.4L	28.4	14.0	1.4	9.4	RP6402
	Angulated Star Screw Torque Driver - Short 17.0L	17.0	11.0	1.4	7.0	RP6403
	Angulated Star Screw Torque Driver - Long 22.0L	22.0	16.0	1.4	7.0	RP6404
	Angulated Star Screw Handpiece Driver - Extra Short 20.0L	20.0	7.0	1.4	2.35	RP6405
	Angulated Star Screw Handpiece Driver - Short 25.0L	25.0	12.0	1.4	2.35	RP6406
	Angulated Star Screw Handpiece Driver - Long 30.0L	30.0	17.0	1.4	2.35	RP6407

Digital Analogs



	Description	L	D1	Catalog No.		Description	Catalog No.		Description	L	D1	Catalog No.
	UNP CloseFit™ Digital Analog	10.0	3.55	UNP1000		Retaining Screw	RS1002		NP CloseFit™ Digital Analog	10.0	3.55	NP1000

	Description	Catalog No.
	UNP CloseFit™ Abutment Screw	UNP0001
	NP CloseFit™ Abutment Screw	NP0001





TMA - Multi Unit Screws

	Description	Catalog No.
	TMA Scan Body Screw	TM0001
	TMA Prosthetic Screw	RS3404

STMA / TMA Scan Bodies | For Intra-oral and Desktop Scanner

	Description	L	D1	Catalog No.		Description	L	D1	Catalog No.
	Single TMA Scan Body	6.0	4.9	TM0006S		TMA Scan Body	6.0	4.9	TM0006
		9.0	4.9	TM0009S			9.0	4.9	TM0009

STMA / TMA Cementing Cone & Temporary Cylinder

	Description	L	D1	D2	H	Catalog No.		Description	L	D1	D2	Catalog No.
	Single TMA Titanium Temporary	12.0	4.9	3.5	10.5	RS4900S		Single TMA Cementing Cone, low profile	4.9	5.5	3.2	TM0011S
								TMA Cementing Cone, low profile	4.9	5.5	3.2	TM0011
	TMA Titanium Temporary	12.0	4.9	3.5	10.5	RS4900		TMA Cementing Cone	4.9	4.9	3.8	TM0010

Tool Drivers

	Description	L	Catalog No.		Description	L	Catalog No.
	Star Hand Driver Short	23.4	RP0064		Star Hand Driver Long	28.4	RP0004

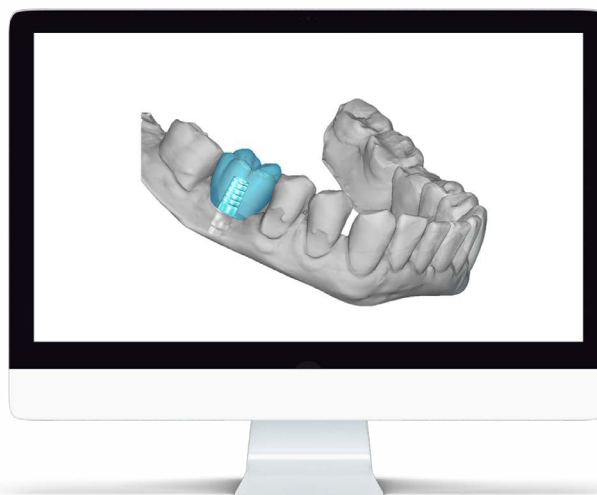

TMA™ - Multi Unit Recommended Torque 35(Ncm)

Our TMA™ (Trans Mucosal Abutment) system is indicated for multiple-unit, screw-retained restorations, and may be used in combination with an implant-level framework design.

- Elevates restorative seating platform when implant-level restoration is not practical
- Provides better access when using implants with divergent angles
- Accommodates full and partial edentulous arches
- Available in straight or angled (17°, 30°, 45°) with different gingival heights
- Abutments are delivered with handles for easy insertion and seating

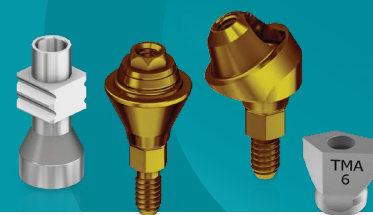

		Description	GH	Catalog No.
		NP Straight Trans Mucosal Abutment	1.0	NP0032
			2.0	NP0033
			3.0	NP0034
			4.0	NP3729
			5.0	NP3730
		NP Angled Trans Mucosal Abutment 17°	2.8	NP0035
		NP Angled Trans Mucosal Abutment 17°	3.9	NP0038
		NP Angled Trans Mucosal Abutment 30°	3.4	NP0036
		NP Angled Trans Mucosal Abutment 30°	4.9	NP0037

Transfers

	Description	L	D1	D2	Catalog No.
	TMA Impression Coping Open Tray	11.0	4.9	3.1	RS5006
	TMA Closed Tray Transfer	8.0	4.9	4.1	RS5011
	TMA Healing Cup	5.5	4.9	3.5	RS5005

Analogs

	TMA Abutment Replica	16.8	3.35	-	RS5004
	TMA Digital Model Replica <small>Recommended torque 15(Ncm)</small>	12.0	4.9	3.8	RS1001
	Description	L	D1	Catalog No.	
	TMA Scan Body	6.0	4.9	TM0006	
		9.0	4.9	TM0009	

TMA Screw For Scan Body & Cementing Cone

	Description	Catalog No.
	TMA Scan Body Screw	TM0001





TMA Screw Temporary Cylinder & STMA Direct Option

	Description	Catalog No.
	TMA Prosthetic Screw	RS3404

Snap-On

	Description	L	D1	D2	Catalog No.		Description	Catalog No.
	TMA Snap-On Transfer	8.0	4.9	3.2	RS5012		IRIS™, Impression coping	IR0179

TMA Prosthetics

	Description	L	D1	D2	H	Catalog No.		Description	L	D1	D2	Catalog No.
	TMA Titanium Temporary	12.0	4.9	3.5	10.5	RS4900		TMA Cementing Cone, low profile	4.9	5.5	3.2	TM0011
	TMA Plastic Casting Sleeve /Prosthetic Screw	12.0	4.9	3.3	10.5	RS5001		TMA Cementing Cone	4.9	5.5	2.9	TM0010

Overdenture Restoration

Recommended Torque 25(Ncm)



		Description	GH	RH	H	Catalog No.
		UNP Ball Attachment	0.6	2.45	3.05	UNP0020
			1.0	2.45	3.45	UNP0021
			2.0	2.45	4.45	UNP0022
			3.0	2.45	5.45	UNP0023
			4.0	2.45	6.45	UNP0024
			5.0	2.45	7.45	UNP0025
		NP Ball Attachment	0.6	2.7	4.1	NP0020
			1.0	2.7	4.5	NP0021
			2.0	2.7	5.5	NP0022
			3.0	2.7	6.5	NP0023
			4.0	2.7	7.5	NP0024

	Description	L	Ø	Catalog No.
	Ball Attachment Replica	16.6	4.0	RS5740

	Description	L	Ø	D2	Catalog No.
	Plastic Ball Cap White (Nylon)	2.6	4.1	3.6	RS2660
	Plastic Ball Cap Pink Soft (Nylon)	2.6	4.1	3.6	RS2662
	Titanium Ball Cap	2.9	4.7	4.7	RS2670
	Stainless Steel Ball Cap	2.90	4.70	4.70	RS2675SS

Grip™ - Overdenture Attachment

As an addition to our wide variety of prosthetic solutions.

Implant supported overdentures are among the most practical prosthetic solutions for patients who cannot utilize fixed restorations, or as an interim solution for patients who are waiting for the osseointegration process of their newly placed implants.

The Grip™ attachment system is a versatile solution, designed to ensure maximum denture retention and stability both for maxillary and mandibular dentures. The variety of retentive caps allow dentists to choose the required retention level needed for each individual case and can easily be replaced, when needed.

The Grip™ attachment system is available for Internal Hex in a range of gingival heights, to enable a reliable, long lasting and cost-effective solution for your patients.

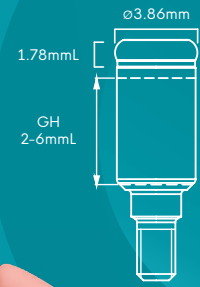

NP Grip™ Abutments

	Description	Catalog No.
	Grip NP Abutment 1mm	NP0051
	Grip NP Abutment 2mm	NP0052
	Grip NP Abutment 3mm	NP0053
	Grip NP Abutment 4mm	NP0054
	Grip NP Abutment 5mm	NP0055
	Grip NP Abutment 6mm	NP0056

	Description	Catalog No.
	Grip™ for TMA	TM0100
	Grip™ for Bar, M2 thread	RS0101

Included in Sales Pack

	Housing		Light	RS6426
	Processing		Regular	
	Extra Light		Block Out Spacer	



Or







Grip™ Extended Range processing set

	Description		Description	Catalog No.
	Housing		Light	RS6427
	Processing		Regular	
	Zero		Block Out Spacer	
	Extra Light			



Grip™ Retention Caps

Grip Retention 4 Pack		Description	Catalog No.
		 Extra Light	RS6417
		 Light	RS6418
		 Regular	RS6419

Grip™ Extended Range Retention 4 Pack		Description	Catalog No.
		 Zero	RS6420
		 Extra Light	RS6421
		 Light	RS6422
		 Regular	RS6423



Grip™ Accosories

	Description	Catalog No.		Description	Catalog No.
	Grip™ Impression Coping 4 Pack Includes RS6415 Grip™ Processing 4 Pack	RS6414		Grip™ Replica 4 Pack	RS2508
	Metal Housing 4 Pack Includes RS6415 Grip™ Processing 4 Pack	RS6413			Grip™ Processing 4 Pack
	Grip™ Block Out Spacer 4 Pack	RS6424			Grip™ Processing 20 Pack

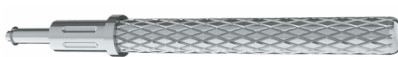
Grip™ Tools

	Description	Catalog No.
	Grip™ core tool	RS6200

Designed for inserting and removing the Grip™ retention males from the metal housing

	Description	Catalog No.		Description	Catalog No.		Description	Catalog No.
	Star Hand Driver Short	RP0064		1.27 Hex torque driver-long	RS6082		1.27 Hex driver for handpiece - long	RS9035
	Star Hand Driver Long	RP0004		1.27 Hex torque driver-short	RS6080		1.27 Hex driver for handpiece - short	RS9030

Surgical Kits

Successful surgical procedures start with having the right instruments and tools to ensure your desired treatment outcomes are met.

That's why our range has everything you need, including drills, keys, ratchets and insertion tools.

Not only do they make procedures safer and simpler, they result in an enhanced patient experience as well.

Our Surgical Kits streamline and simplify your implant procedures.



Advanced Kit CF6302

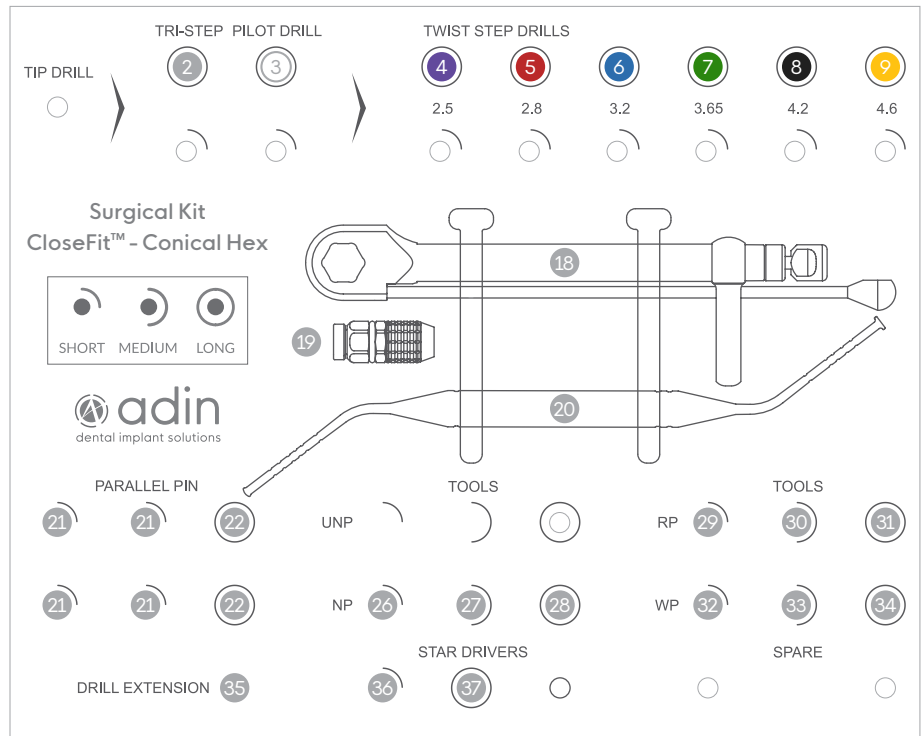

		Drills	Catalog No.
3		Pilot Drill 2mmD x 8-18mmL	DL1820
4		Twist Step Drill 2.3/2.8mmD x 8-18mmL	DL1828
5		Twist Step Drill 2.8/3.2mmD x 8-18mmL	DL1832
6		Twist Step Drill 3.2/3.6mmD x 8-18mmL	DL1836
7		Twist Step Drill 3.8/4.2mmD x 8-18mmL	DL1842
8		Twist Step Drill 4.2/4.6mmD x 8-18mmL	DL1846

		Surgical Tools	Catalog No.
18		Surgical Torque Ratchet 35-100 Ncm	RS6111
19		Wrench Ratchet Surgical Instruments Handle	RA0050
20		Depth Probe	RS6180

		Parallel Pins	Catalog No.
21		Parallel Pin Short 11mm (qty. 4)	RS6150
22		Parallel Pin Short 16mm (qty. 2)	RS6155

		Insertion Tools	Catalog No.
26		NP 2mm Hex Handpiece Adapter - Short	NP0068
27		NP 2mm Hex Handpiece Adapter - Medium	NP0071
28		NP 2mm Hex Handpiece Adapter - Long	NP0074
29		RP 2.25mm Hex Handpiece Adapter - Short	RP0068
30		RP 2.25mm Hex Handpiece Adapter - Medium	RP0071
31		RP 2.25mm Hex Handpiece Adapter - Long	RP0074
32		WP 2.65mm Hex Handpiece Adapter - Short	WP0068
33		WP 2.65mm Hex Handpiece Adapter - Medium	WP0071
34		WP 2.65mm Hex Handpiece Adapter - Long	WP0074

		Drill Extension	Catalog No.
35		Drill Extension	RS9027

		Hex Drivers	Catalog No.
36		Star Hand Driver - Short	RP0064
37		Star Hand Driver - Long	RP0004

*The advanced kit is also available with short drills | Catalog No. CF6304

Starter Kit CF6303

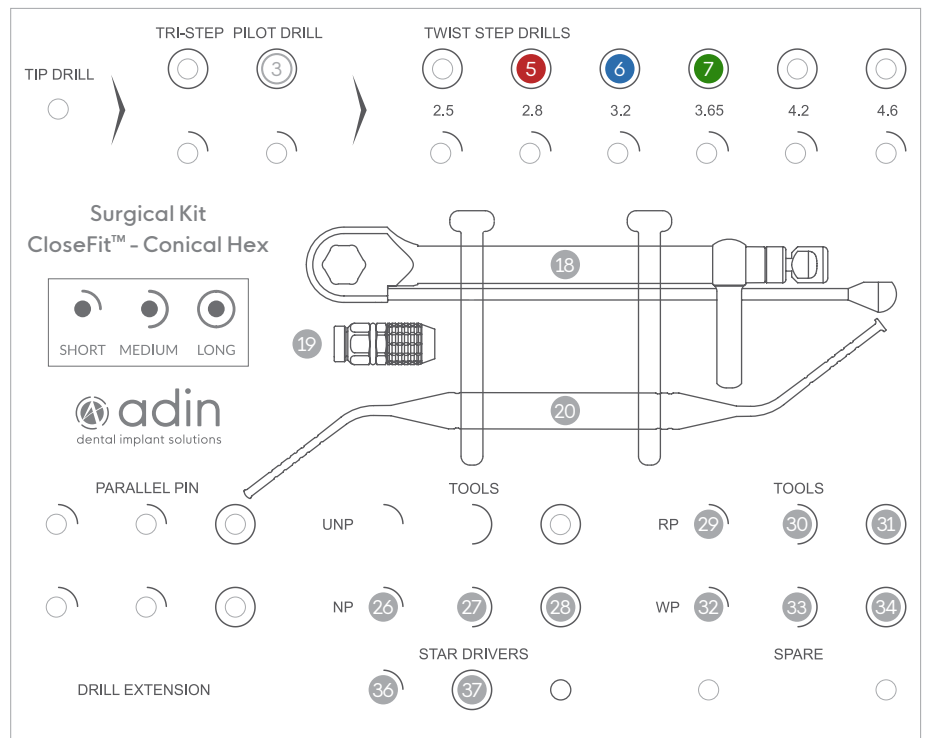

		Drills	Catalog No.
3		Pilot Drill 2mmD x 8-18mmL	DL1820
4		Twist Step Drill 2.3/2.8mmD x 8-18mmL	DL1828
5		Twist Step Drill 2.8/3.2mmD x 8-18mmL	DL1832
6		Twist Step Drill 3.2/3.6mmD x 8-18mmL	DL1836
7		Twist Step Drill 3.8/4.2mmD x 8-18mmL	DL1842

		Insertion Tools	Catalog No.
26		NP 2mm Hex Handpiece Adapter - Short	NP0068
27		NP 2mm Hex Handpiece Adapter - Medium	NP0071
28		NP 2mm Hex Handpiece Adapter - Long	NP0074
29		RP 2.25mm Hex Handpiece Adapter - Short	RP0068
30		RP 2.25mm Hex Handpiece Adapter - Medium	RP0071
31		RP 2.25mm Hex Handpiece Adapter - Long	RP0074
32		WP 2.65mm Hex Handpiece Adapter - Short	WP0068
33		WP 2.65mm Hex Handpiece Adapter - Medium	WP0071
34		WP 2.65mm Hex Handpiece Adapter - Long	WP0074

		Surgical Tools	Catalog No.
20		Wrench Ratchet	RS6100
21		Wrench Ratchet Surgical Instruments Handle	RA0050

		Hex Drivers	Catalog No.
36		Star Hand Driver - Short	RP0064
37		Star Hand Driver - Long	RP0004

Drills and Tools

Our DLC (Diamond Like Carbon) Tri-Step/Twist Step Surgical Drills are uniquely designed and coated to improve the surgical drilling process.

Tri-Step & Twist-Step DLC drills simplify the cutting process, save time and minimize risks.

Our improved DLC drill coating provides state-of-the-art hardness and slickness that increases lifespan of the drill, maintains sharpness for extended drilling and generates less heat, thereby reducing chances of heating the bone or complications arising from conventional drilling protocols.

The drills come in the following diameters (mm): 2.0, 2.5, 2.8, 3.2, 3.6, 4.2, 4.6, 5.2, 5.6

Specially designed for Adin's implants and suitable for their simple and convenient drilling protocol.

They are clearly and conveniently marked and can be used with or without drill stops.



Tri-Step Drills









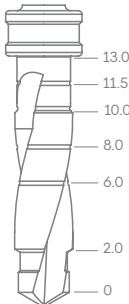

Adin's Tri-Step drills condense drilling protocols and avoid the need for using multiple drills throughout complex procedures.

Because friction at the cutting site is reduced, complications common with high speed drilling are decreased and faster & better recovery can occur.









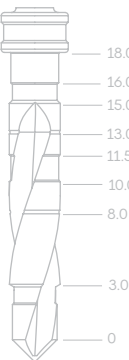

L		Ø	Size	Catalog No.
		1.8-3.2	Short	TD1511
		1.8-3.2	Long	TD2218

Twist Step Drills

Short 6-13mm





L		Ø	Color	Catalog No.
		2.0	White	DL1320
		1.8-2.5	Purple	DL1325
		2.3-2.8	Red	DL1328
		2.8-3.2	Blue	DL1332
		3.2-3.6	Green	DL1336
		3.9	Pink	DL1339
		3.8-4.2	Black	DL1342
		4.2-4.6	Yellow	DL1346
		4.8-5.2	Brown	DL1352
		5.2-5.6	Grey	DL1356

Long 8-18mm













L		Ø	Color	Catalog No.
		2.0	White	DL1820
		1.8-2.5	Purple	DL1825
		2.3-2.8	Red	DL1828
		2.8-3.2	Blue	DL1832
		3.2-3.6	Green	DL1836
		3.9	Pink	DL1839
		3.8-4.2	Black	DL1842
		4.2-4.6	Yellow	DL1846
		4.8-5.2	Brown	DL1852
		5.2-5.6	Grey	DL1856

Surgical Tools















	Surgical Torque Ratchet 35-100 Ncm	RS6111
	Prosthetic Torque Ratchet 15-35 Ncm	RS6112
	Wrench Ratchet	RS6100
	Surgical Driver	RS7001
	Depth Probe	RS6180



Hand & Torque Drivers Recommended Torque 25(Ncm)

	Description	Catalog No.
	Star Hand Driver 23.4mm *For Angled TMA/TMA prosthetic screw	RP0064
	Star Hand Driver 23.4mm *For Angled TMA/TMA prosthetic screw	RP0004
	TMA/FC Female Hand Hex Driver 22.4mm *For straight TMA/Flat connection	RS6193
	TMA/FC Female Hand Hex Driver 28.4mm *For straight TMA/Flat connection	RS6191
	Wrench Ratchet Surgical Instruments Handle 16.7mm	RA0050
	UNP/NP Abutment insertion tool 25.9mm	UNP1001
	NP 2mm Hex Torque Driver 17mm	NP0006
	NP 2mm Hex Torque Driver 27mm	NP0005
	Star Torque Driver 20.4mm *For Angled TMA/TMA prosthetic screw	RP0065
	Star Torque Driver 25.4mm *For Angled TMA/TMA prosthetic screw	RP0005
	Torque Driver for Ball Attachment 24.4mm	RS6090
	TMA/FC Hex Torque Driver 20mm *For straight TMA/Flat connection	RS6197
	TMA/FC Hex Torque Driver 25mm *For straight TMA/Flat connection	RS6196





Handpiece Drivers Recommended Torque 35(Ncm)

	NP 2mm Hex Handpiece Adapter 23.7mm	NP0068
	NP 2mm Hex Handpiece Adapter 27.7mm	NP0071
	NP 2mm Hex Handpiece Adapter 36mm	NP0074
	NP 2mm Hex Handpiece Adapter 20mm	NP0062
	NP 2mm Hex Handpiece Adapter 25mm	NP0072
	UNP 2mm Hex Handpiece Adapter Short 23.60L	UNP0068
	UNP 2mm Hex Handpiece Adapter Medium 27.20L	UNP0071
	UNP 2mm Hex Handpiece Adapter Long 36.00L	UNP0074
	Star Handpiece Driver 25mm *For Angled TMA/TMA prosthetic screw	RP0018
	Star Handpiece Drive 30mm *For Angled TMA/TMA prosthetic screw	RP0019
	TMA/FC Hex Handpiece Adapter 20mm *For straight TMA/Flat connection	RS6194
	TMA/FC Hex Handpiece Adapter 25mm *For straight TMA/Flat connection	RS6195A

Tools

	Description	Catalog No.
	Parallel Pin 11mm	RS6150
	Parallel Pin 16mm	RS6155
	Drill Extension	RS9027

Osteotomes

	Description	Catalog No.
	Osteotome Handle	HA0074
	Osteotome Insert 2.0mmD	HA0061
	Osteotome Insert 2.8mmD	HA0064
	Osteotome Insert 3.25mmD	HA0067
	Osteotome Insert 3.65mmD	HA0070

Guided Surgery

The adinguide™ was created with you in mind, bringing the guided surgery world to your clinic.

The kits were specifically designed to support effortless procedures, accurate and predictable implant placement.

The ActiveFlow™ Irrigation Technology is a unique design that forces coolant through the guide to ensure irrigation reaches the bone and prevents overheating.

The adinguide™ drills are designed with carved channels which allow saline coolant from your hand-piece to stream through the sleeve directly into the osteotomy site while drilling.

Our uniquely designed drill kit is intuitive and easy to use by implant diameter and length.

The Tissue Punch and Pilot Drill allow for easy flapless access.

Keyless procedure enables easy handling and full visibility of surgical field.

Self-centering drills- controlled by a 5.5mm diameter cylinder at the top of each drill centers the drill in the guide's sleeve.

Self-centering cylinder engages the sleeve before the drill engages the osteotomy in order to ensure correct positioning of the drill.

Built-in stoppers- ensure precise and accurate drilling to the desired depth.



Guided Surgery Kit

CloseFit™ UNP/NP Narrow Implants Drills & Tools

GSK002

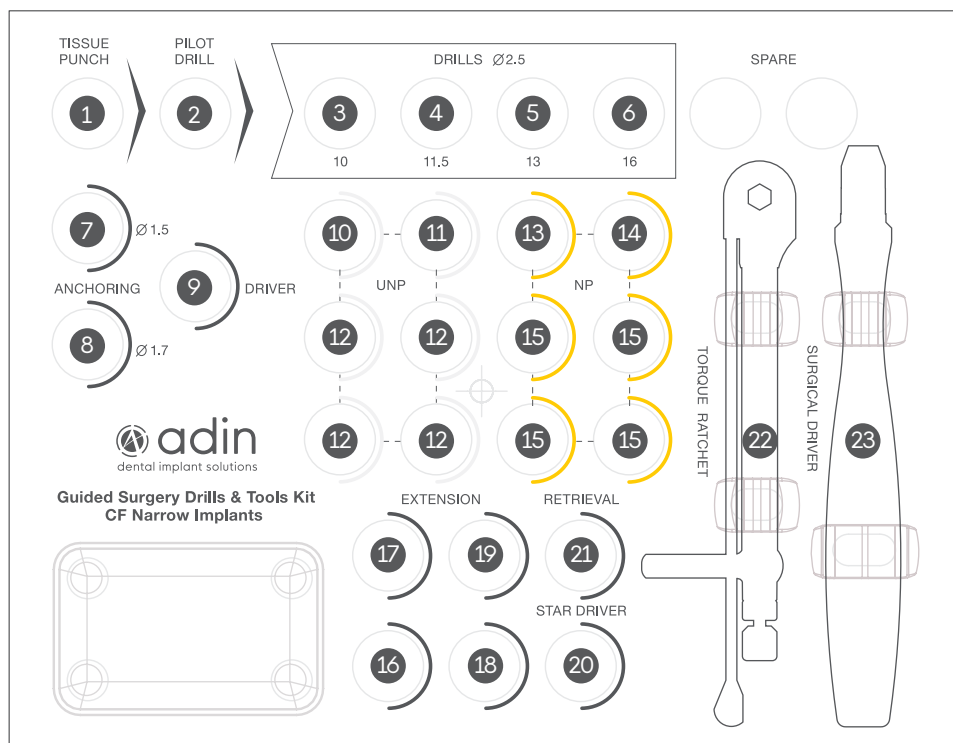













For full
guided
procedure:













CloseFit™ UNP/NP
Narrow Implant Platform





Narrow Implants 3.3mmD Sleeve
GS0033



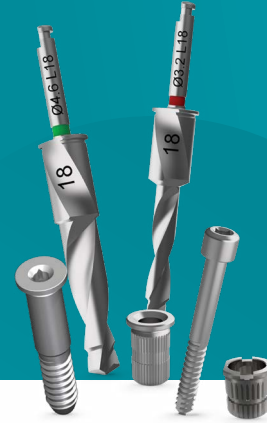

	Description	Catalog No.
1	 Narrow Tissue Punch 3.0mmD, S-3.3	GSN3033
2	 Pilot Drill S-3.3, 2.5/1.8mmDx6.0mmL	GSN0625
3	 Drill S-3.3, 2.5/1.8mmDx10.0mmL	GSN1025
4	 Drill S-3.3, 2.5/1.8mmDx11.5mmL	GSN1125
5	 Drill S-3.3, 2.5/1.8mmDx13.0mmL	GSN1325
6	 Drill S-3.3, 2.5/1.8mmDx16.0mmL	GSN1625
7	 Anchoring Drill S-2.0, 2.0/1.5mmDx19mmL	GS1915
8	 Anchoring Drill S-2.0, 2.0/1.7mmDx19mmL	GS1917
9	 Handpiece Guide Fixation Screw Driver	GS0028
10	 Guided UNP Handpiece Fixture Mount S-3.3	GS0018
11	 Guided UNP Ratchet Fixture Mount S-3.3	GS0016
12	 Guided UNP Ratchet Fixture Mount S-3.3, Screw Retained	GS0014

	Description	Catalog No.
13	 Guided NP Handpiece Fixture Mount S-3.3	GS0017
14	 Guided NP Ratchet Fixture Mount S-3.3	GS0019
15	 Guided NP Ratchet Fixture Mount S-3.3, Screw Retained	GS0013
16	 Manual Socket L10.5	GS0023
17	 Manual Socket L14.5	GS0024
18	 Handpiece Socket L10.5	GS0021
19	 Drill extension	RS9027
20	 Star Hand Driver - Long	RP0004
21	 NP&UNP Ratchet retrieval tool	GS0045
22	 Surgical Torque Ratchet 35-100 Ncm for hex 4mm	GS6111
23	 Guide Fixation Screw Driver	GS0027



18mm Drills

	Description	Catalog No.
	Drill S-5.5, 2.5/1.8mmDx18.0mmL	GS1825
	Drill S-3.3, 2.5/1.8mmDx18.0mmL	GSN1825

	Description	Purchase Options	Catalog No.
	Guided Vertical Fixation Screw S-3.3	x3 pack	GS0006
	2.0mmD Anchoring Screw	x3 pack	GS1920
	2.0mmD Anchoring Sleeve	x3 pack	GS0020
	3.3mmD Narrow Implants Sleeve	x1 pack	GS0033
x3 pack		GS0033x3	
x10 pack		GS0033x10	

* Illustrations are not to scale

* Availability of the products in some places is limited and depends on local regulations.

* For more information, please contact your local representative.

